



WM-02

PuyoPuyo™ TETRIS® 2

THE ULTIMATE PUZZLE MATCH

Online Manual



Tetris ® & © 1985 ~ 2021 Tetris Holding.

Tetris logos, Tetris theme song and Tetriminos are trademarks of Tetris Holding.

The Tetris trade dress is owned by Tetris Holding.

Licensed to The Tetris Company.

Tetris Game Design by Alexey Pajitnov.

All Rights Reserved.

© SEGA

“PS”, “PlayStation”, “PS4”, “PS5” and “DUALSHOCK” are registered trademarks or trademarks of Sony Interactive Entertainment Inc.

Library programs ©Sony Interactive Entertainment Inc.

The Nintendo Switch LOGO, Nintendo Switch is a trademark of Nintendo.

Microsoft, Xbox Series X, Xbox One, Kinect, Xbox Live, and the Xbox logos are registered trademarks or trademarks of Microsoft Corporation in the United States and other countries.

This software uses fonts produced by FONTWORKS Inc. FONTWORKS, and font names are trademarks or registered trademarks of Fontworks Inc.

Browser Compatibility

The correct functioning of this website has been confirmed using the Google Chrome and Safari browsers.

- * It is recommended that you use the latest version of each browser. Older versions may not display the content correctly.
- * Please ensure that Javascript is enabled in your browser's settings.

Unauthorized copying, reproduction, rental, pay for play, public performance or transmission of this game is a violation of applicable laws.

Customer Service

US: 1-866-226-8092 UK/EU: 00-44-845-301-5502 Australia: 1-800-613-162
WEBSITE: www.sega.com/support

Basic Controls

This game can be played by up to 4 players simultaneously. A separate controller is required for each player.

Nintendo Switch™



* The Nintendo Switch™ Lite and Nintendo Switch Pro controller use the same commands.

Detach the Joy-Con™ to use as two separate controllers.

Joy-Con (L)

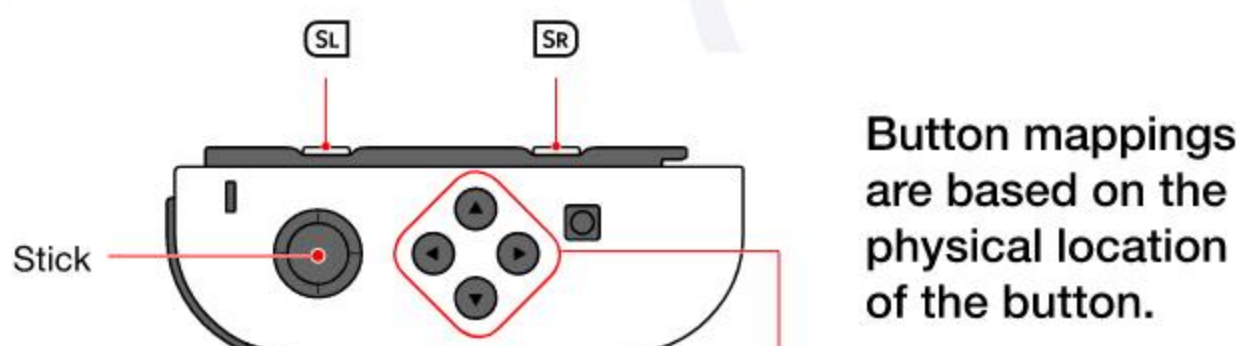

Joy-Con (R)

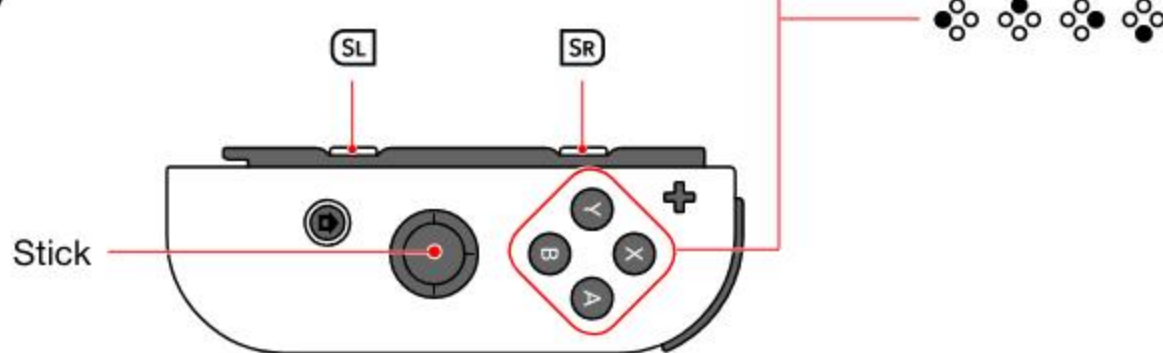

Controls explained in the Online Manual are based on the default setting *Normal*. Controls can be reconfigured via *Options* in *Options & Data*.

	Puyo Puyo™ Controls	Tetris® Controls
Directional Buttons / Stick	←→: Move Puyo ↓: Fast Drop ↑: Quick Drop*	←→: Move Tetrimino ↓: Soft Drop ↑: Hard Drop
A / Ⓜ	Rotate Puyos Right Change Giant Puyo Color	Rotate Tetrimino Right
B / Ⓜ	Rotate Puyos Left Change Giant Puyo Color	Rotate Tetrimino Left
L / R SL / SR	HOLD (<i>Fusion</i> only)	HOLD (except <i>Big Bang</i>)
Y / Ⓜ	Skill 1 (<i>Skill Battle</i> only)	
X / Ⓜ	Skill 2 (<i>Skill Battle</i> only)	
ZR / SR	Skill 3 (<i>Skill Battle</i> only)	
+ / =	Pause Game	

* Only available in certain modes.

PlayStation®4

DUALSHOCK®4 Wireless Controller



Controls explained in the Online Manual are based on the default setting *Normal*. Controls can be reconfigured via *Options* in *Options & Data*.

	Puyo Puyo™ Controls	Tetris® Controls
Directional buttons / Left stick	←→: Move Puyo ↓: Fast Drop ↑: Quick Drop*	←→: Move Tetrimino ↓: Soft Drop ↑: Hard Drop
Ⓞ button	Rotate Puyos Right Change Giant Puyo Color	Rotate Tetrimino Right
ⓧ button	Rotate Puyos Left Change Giant Puyo Color	Rotate Tetrimino Left
L1 / R1 button	HOLD (<i>Fusion</i> only)	HOLD (except <i>Big Bang</i>)
Ⓜ button	Skill 1 (<i>Skill Battle</i> only)	
△ button	Skill 2 (<i>Skill Battle</i> only)	
R2 button	Skill 3 (<i>Skill Battle</i> only)	
OPTIONS button	Pause Game	

* Only available in certain modes.

PlayStation®5

Wireless Controller

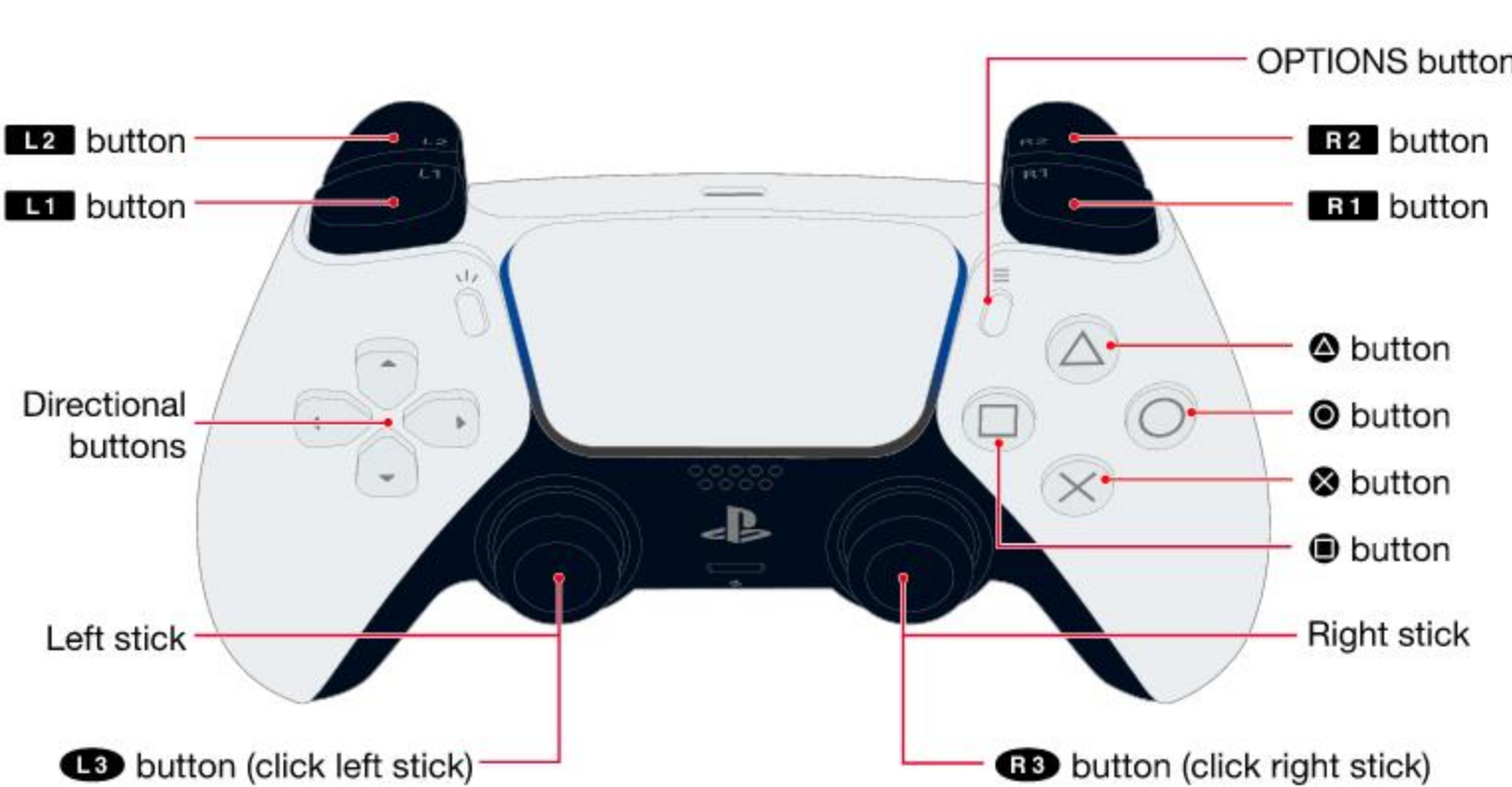

Controls explained in the Online Manual are based on the default setting *Normal*. Controls can be reconfigured via *Options* in *Options & Data*.

	Puyo Puyo™ Controls	Tetris® Controls
Directional Buttons / left stick	←→: Move Puyo ↓: Fast Drop ↑: Quick Drop*	←→: Move Tetrimino ↓: Soft Drop ↑: Hard Drop
Ⓞ button	Rotate Puyos Right Change Giant Puyo Color	Rotate Tetrimino Right
ⓧ button	Rotate Puyos Left Change Giant Puyo Color	Rotate Tetrimino Left
L1 / R1 button	HOLD (<i>Fusion</i> only)	HOLD (except <i>Big Bang</i>)
Ⓜ button	Skill 1 (<i>Skill Battle</i> only)	
△ button	Skill 2 (<i>Skill Battle</i> only)	
R2 button	Skill 3 (<i>Skill Battle</i> only)	
OPTIONS button	Pause Game	

* Only available in certain modes.

Xbox One

Wireless Controller



Controls explained in the Online Manual are based on the default setting *Normal*. Controls can be reconfigured via *Options* in *Options & Data*.

	Puyo Puyo™ Controls	Tetris® Controls
D-Pad / Left stick	←→: Move Puyo ↓: Fast Drop ↑: Quick Drop*	←→: Move Tetrimino ↓: Soft Drop ↑: Hard Drop
B button	Rotate Puyos Right Change Giant Puyo Color	Rotate Tetrimino Right
A button	Rotate Puyos Left Change Giant Puyo Color	Rotate Tetrimino Left
LB / RB	HOLD (<i>Fusion</i> only)	HOLD (except <i>Big Bang</i>)
X button	Skill 1 (<i>Skill Battle</i> only)	
Y button	Skill 2 (<i>Skill Battle</i> only)	
RT	Skill 3 (<i>Skill Battle</i> only)	
Menu button	Pause Game	

* Only available in certain modes.

Xbox Series X|S

Wireless Controller

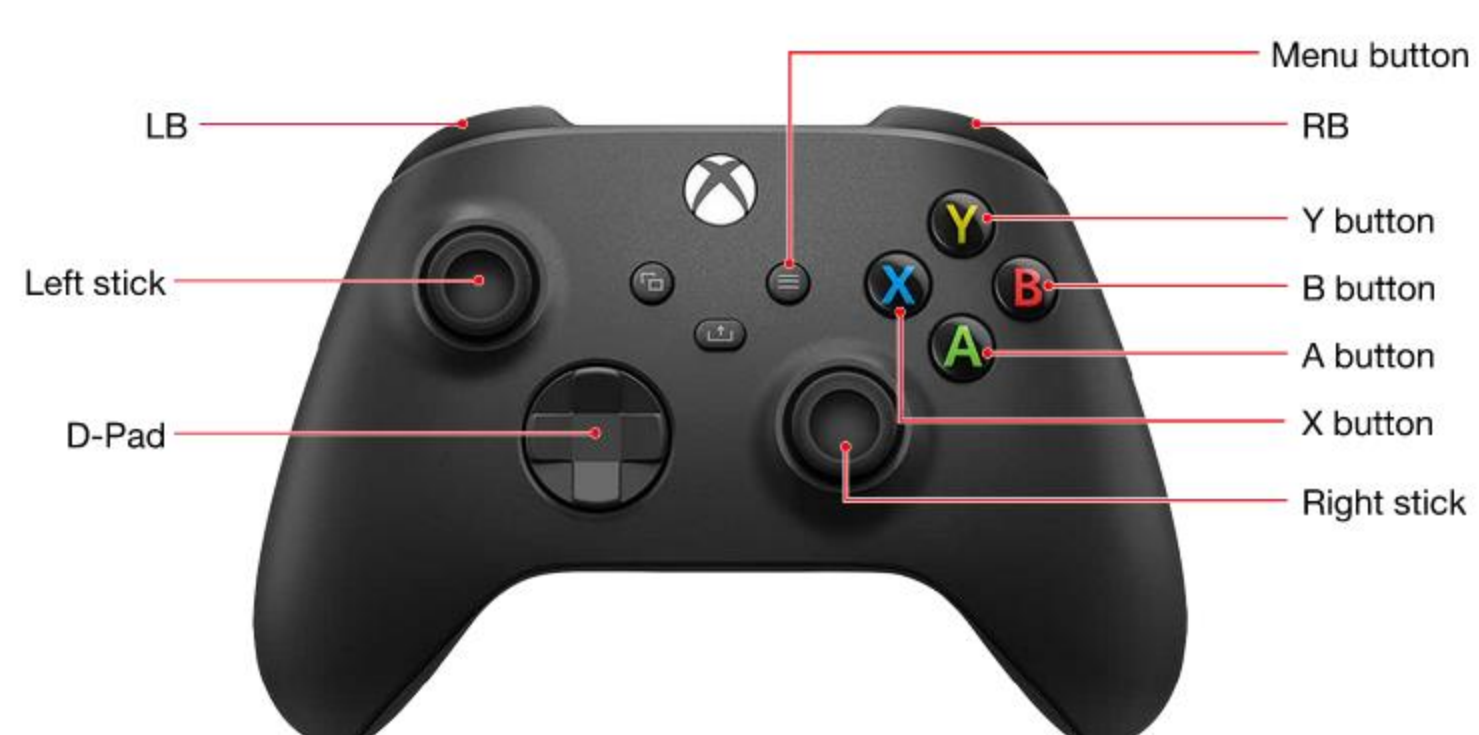

Controls explained in the Online Manual are based on the default setting *Normal*. Controls can be reconfigured via *Options* in *Options & Data*.

	Puyo Puyo™ Controls	Tetris® Controls
D-Pad / Left stick	←→: Move Puyo ↓: Fast Drop ↑: Quick Drop*	←→: Move Tetrimino ↓: Soft Drop ↑: Hard Drop
B button	Rotate Puyos Right Change Giant Puyo Color	Rotate Tetrimino Right
A button	Rotate Puyos Left Change Giant Puyo Color	Rotate Tetrimino Left
LB / RB	HOLD (<i>Fusion</i> only)	HOLD (except <i>Big Bang</i>)
X button	Skill 1 (<i>Skill Battle</i> only)	
Y button	Skill 2 (<i>Skill Battle</i> only)	
RT	Skill 3 (<i>Skill Battle</i> only)	
Menu button	Pause Game	

* Only available in certain modes.



Title Screen

At the title screen you can select the Main Menu, or jump straight into a match with either of the regular playstyles. Gameplay instructions for each playstyle can be found in the sections linked below:



Puyo Puyo™

Play Puyo Puyo using **ENDLESS PUYO** settings.

Tetris®

Play Tetris using **MARATHON** settings.

Main Menu



Menu and other non-gameplay controls are displayed at the bottom of the screen.

- * Most game screens in this manual are non-preferentially taken from the Nintendo Switch™ version of the game.
- * This game supports an autosave feature. Do not switch off the console while saving is in progress.

Adventure

Compete against various characters and clear missions to advance the story.

Solo

A single player game mode with a wide variety of rule settings.

Multiplayer

Play against friends either on a single console or with multiple Nintendo Switch™ consoles.

Options & Data

Check your personal stats and change game settings. Purchase items at the *Shop* using points earned through gameplay.

Online

Go online to compete against other players and watch replays.

Lessons

Learn the basic rules of *Puyo Puyo™*, *Fusion*, *Tetris®*, and *Skill Battle*, as well as some more advanced techniques!



Basic Rules

Learn the basic rules of Puyo Puyo™ and Tetris®.

Puyo Puyo™

The name of the game is to “pop” Puyos by moving and rotating sets as they fall from the top of the Board and stack atop each other. When Puyos stack up to the **X** at the top center of the Board, that player loses.



1 X

If Puyos stack up to here, then you lose!

2 Next Puyos

The next pair of Puyos to drop into the Board.

3 Puyo Pairs

Puyos drop in randomly colored pairs. Sometimes two of the same color will drop together.

4 Nuisance Queue

A waiting area for Garbage Puyos sent by your opponent. These appear in various sizes and shapes relative to the number of Garbage Puyos waiting to rain down any moment.

Garbage Puyo						
Small	Big	Rock	Star	Moon	Crown	Comet
1	6	30	180	360	720	1440

5 Player Board

7 Score

9 Win Stars

6 Opponent Board

8 Player Icon and Name

10 Opponent Name

Removing Puyos

Touch four or more Puyos of the same color together horizontally and/or vertically to pop them. This will create Garbage Puyos which are sent to your opponent's Nuisance Queue. Garbage Puyos can be removed from the Board by popping regular Puyos that are touching them.



Giant Puyo

A single colored Giant Puyo that separates into four regular Puyos when it lands. Press either *Rotate* button to change its color.



Chains

When Puyos are popped, the ones on top will drop down to fill the gaps. If these then connect up and pop, it becomes a chain. The more chains you can pop in a sequence, the more Garbage Puyos are sent to your opponent's Board!



Offset

Garbage Puyos can be an ominous presence in the Nuisance Queue, but all is not lost—these can be removed by simply sending your own. One Garbage Puyo will be removed from your queue for each one you produce, the two effectively canceling each other out.

Simultaneous Clear

Pop two or more colors simultaneously and extra Garbage Puyos will be sent to your opponent.



All Clear

Pop every Puyo on your Board to receive a special bonus—your next attack will send a LOT of Garbage Puyos to your opponent!

Quick Drop

Send the falling Puyos to the bottom of your Board in an instant. This move is available in *Skill Battle*, *Party*, *Fusion*, *Big Bang*, *Challenge*, and *Tiny Puyo* rules. It can also be enabled in *Versus*, *Skill Battle*, and *Swap* rules via *Game Settings* at the standby screen.

* This move cannot be used in *Puzzle League* matches *Online*.

Tetris®

Remove lines of Blocks from the Matrix by moving and rotating Tetriminos as they fall from the top. When the Blocks stack past the top of the Matrix, they will “Lock Out,” eliminating the player from the match.



1 Matrix Top

If the Tetriminos stack up to here, you lose!

2 Hold Queue

Shows the currently held Tetrimino.

3 Next Queue

Shows the next Tetriminos to fall.

4 Tetriminos

There are seven Tetrimino shapes. Move and rotate them as they fall.

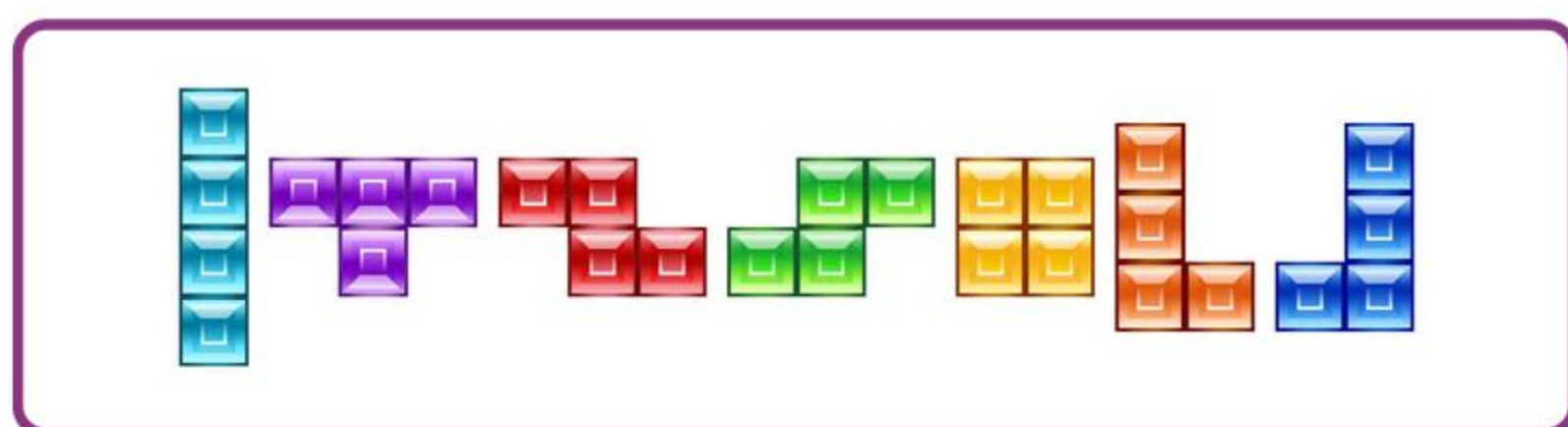

5 Ghost Piece

Shows how the current Tetrimino will lock into place if it continues straight down.

6 Garbage Block Preview

Shows incoming Garbage Blocks sent by your opponent.

7 Player Matrix

9 Score

11 Win Stars

8 Opponent Matrix

10 Player Icon and Name

12 Opponent Name

Removing Blocks

Stack the falling Tetriminos to form a horizontal line across the full width of the Matrix, and the entire line will disappear. Blocks stacked above will drop down to close the empty row.



Hold Queue

“Hold” a falling Tetrimino to set it aside for later. Only one can be held in the Hold Queue at a time. Hold a new Tetrimino when one has already been set to swap their positions.

Combo

Removing lines with successive Tetriminos is called a combo. The more you use this technique, the more Garbage Blocks are sent to your opponent's Matrix!

Tetris™ Line Clear

Simultaneously remove 4 lines to send a LOT of Garbage Blocks to your opponent's Matrix!



T-Spin

A super advanced technique where a T-Tetrimino is rotated at the last moment to fit into a T-Slot before it Locks Down. Get it right, and your opponent will be treated to a deluge of Garbage Blocks!



Back-to-Back

Successful completion of two Tetris™ Line Clears or T-Spin Clears with no simple Line Clears in between is called a Back-to-Back. This will earn you a bonus score.

Perfect Clear

Remove every single Block from the Matrix for a Perfect Clear. This will earn you a huge bonus score and send a truckload of Garbage Blocks to your opponent's Matrix!

Match Rules

Learn the difference between the various rulesets.

Versus

A simple battle mode. Players and CPU opponents alike decide their own playstyle (Puyo Puyo™ or Tetris®). Standard game rules apply to each playstyle selected.



Tetris Attack Gauge

In a Puyo Puyo vs Tetris match, the Tetris Matrix will display an attack gauge. The gauge fills as lines are removed, and Garbage Blocks are sent when it reaches capacity.



* The attack gauge is only displayed during mixed games in *Versus* and *Party*. In other modes and Tetris vs Tetris games, a line of Garbage Blocks will be sent each time a line is removed.

Puyo Puyo vs Tetris Attacks

The Tetris player sends Garbage Blocks to the Puyo Puyo Board which drop in from the top. The Puyo Puyo player sends Garbage Puyos to the Tetris Matrix which appear in rows at the bottom.

Garbage Blocks are removed together with neighboring Puyos.

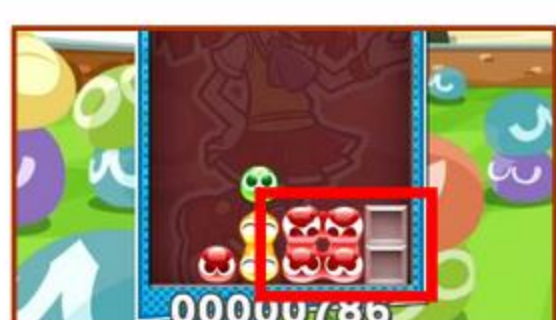

Garbage Puyos are removed by filling the spaces in the row.



Skill Battle

Play as a team of three characters, each with their own skills.



Your team's playstyle (Puyo Puyo™ / Tetris®), characters, and skills can also be set via *Edit Team* in **OPTIONS & DATA**.

Skill Battle HP System

Reduce your opponent's HP to zero to win the game. Allowing Puyos or Blocks to stack to the top will incur massive damage, but after a Board/Matrix reset, you can continue to play until HP is fully depleted.

When you send Garbage Puyos or Garbage Blocks, the HP gauge will flash a damage preview. The damage will not be inflicted until they actually land in the Board or Matrix though, so try to offset as many as you can to minimize the damage.



Using Skills

Skills come in various types, such as changing the color of Puyos and replenishing HP. Press the button assigned to each character to unleash their skill at the cost of some MP.



Each skill has a cooldown period, a limited amount of time that must lapse between uses.



Skills cannot be used if there is insufficient MP. MP replenishes over time.



* Some skills are exclusive to a given playstyle (Puyo Puyo™ / Tetris®).

Team Development

Choose a *Skill Battle* stage in **ADVENTURE** to level up characters and earn Item Cards.



Party

Choose Puyo Puyo™ or Tetris® and compete for the highest score. Even if the Puyos/Blocks reach the top, the Board/Matrix will reset and you can continue playing until the time runs out.



Remove Items that drop into your Board or Matrix to trigger a variety of effects. There are eleven Item Types in total.

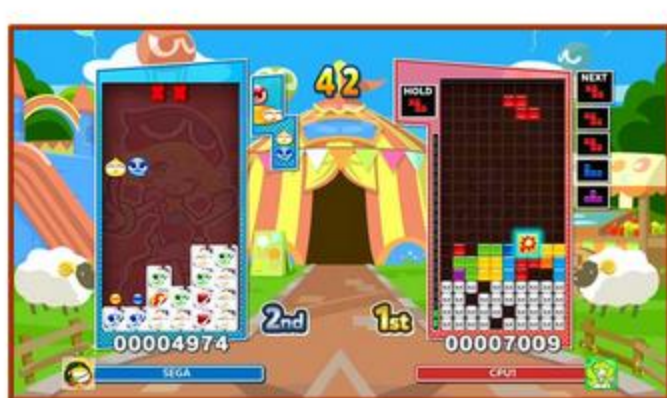

Items

Power-Up Type

	Name	Effect
	Attack Up!	For a limited time, increased Garbage Puyos / Garbage Blocks are sent to the opponent's Board/Matrix.
	Garbage Clear!	Remove all Garbage Puyos / Garbage Blocks from the Player Board/Matrix, including those in the Nuisance Queue.
	Reflection!	For a limited time, all Garbage Puyos / Garbage Blocks received are sent back to the opponent's Board/Matrix.

Nuisance Type

	Name	Effect
	Speed Up!	For a limited time, Puyos and Tetriminos fall at the maximum speed in the opponent's Board.
	Searchlight!	For a limited time, the opponent's Board/Matrix goes dark, with only a small moving portion illuminated.
	No Rotating!	For a limited time, the opponent cannot rotate Puyos or Tetriminos.

Reversal Type

	Name	Effect
	Score Vacuum!	Reduce the opponent's score while increasing your own.

Puyo Puyo Only

	Name	Effect
	Single-Color Tsumo!	For a limited time, all Puyos dropping into your Board will be single color sets.
	Fixed Minos!	For a limited time, all Tetriminos dropping into the opponent's Matrix will be of the same type. * Available only when opponent is playing Tetris®.

Tetris Only

	Name	Effect
	Mino Change!	For a limited time, only single Block Minos will drop into your Matrix.
	Freeze!	For a limited time, all items and Puyos in the opponent's Board will be frozen and inaccessible. * Available only when opponent is playing Puyo Puyo™.

Fusion

In this mode, both Puyos and Tetriminos fall into the same Board. Puyos and Blocks are removed according to standard rules—four or more touching Puyos of the same color, or a full row of Blocks with no gaps.



Crushing Puyos with Tetriminos

When a Tetrimino falls on top of Puyos, it will crush them line by line until it lands at the bottom of the Board or on top of other Blocks. Garbage Puyos are removed completely, but regular color Puyos will quickly drop back in from the top once the Blocks have landed. The game's behavior varies depending on the way the Tetrimino falls.



Freefall / Soft Drop

Tetriminos freefalling or using Soft Drop will crush Puyos one line at a time until landing. As soon as the Tetrimino begins to crush Puyos, you will be unable to control it further, and the next Tetrimino will be released. By stacking the next Tetrimino on top of the Block still falling, it's possible (albeit difficult) to clear 5 or more lines simultaneously!

Hard Drop

Hard Drop Tetriminos to instantly land them, crushing all Puyos in their way.

Other Special Rules

Minos (1 Block) and Diminos (2 Blocks) occasionally make an appearance.



A special piece that alternates between a Puyo set and a Tetrimino will appear for a limited time.

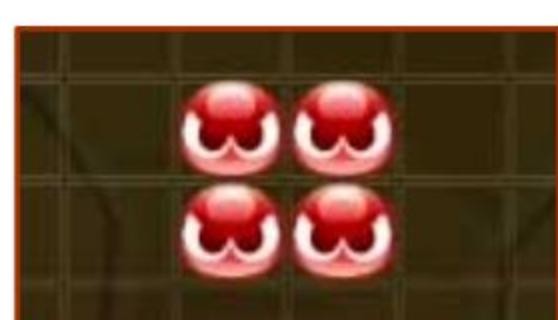

You can begin arranging the next Puyo set or Tetrimino during a chain reaction, or as a Tetrimino crushes Puyos.



If Puyos or Blocks are continually removed within a certain time, it will trigger a mixed chain which sends extra Garbage Blocks to your opponent.

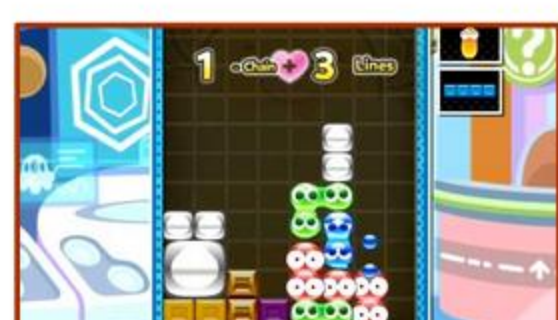

Swap

Gameplay alternates between Puyo Puyo™ and Tetris® playstyles each time the counter reaches zero. Each playstyle has its own Board/Matrix, the one not being played displayed as a sub screen.



Once the countdown has reached zero, any falling Puyos or Tetriminos will continue to freefall. You will not be able to control them anymore, so watch the timer carefully. Remove both Puyos and Blocks within a certain period of time to score a Combo which sends extra Garbage Puyos or Blocks to your opponent's Board/Matrix.



Big Bang

Puyo Puyo players compete in Fever mode: attempt to clear preset stacks of Puyos with a single pair. Tetris players compete in Lucky Attack mode: preset stacks that can be removed a line at a time with each successive Tetrimino. Garbage Puyos and Garbage Blocks produced during the charge up stage accumulate as each player's attack power.



After the charge up time ends, the Garbage Puyo and Garbage Blocks produced by each player are offset against each other. The player that still has Garbage remaining after this uses them to attack the other player. Reduce your opponent's gauge to zero to win.



Challenge

Play using any of the following rulesets.

Endless Fever (Puyo Puyo)

Remove all the chain setups within the time available.

Endless Puyo (Puyo Puyo)

Pop as many Puyos as you can within the time available.

Tiny Puyo (Puyo Puyo)

A wider field and smaller Puyos mean more Puyos per row. Pop as many as you can within the time available.

Sprint (Tetris)

Remove 40 lines as quickly as you can.

Marathon (Tetris)

Remove 150 lines with as high a score as possible.

Ultra (Tetris)

Compete for score by removing as many lines as you can within the time available.

* In *Marathon*, you can disable the 150 line goal and turn it into a limitless score attack mode. You simply set *Endless* to *On* in *Game Settings* and the standby screen. You will also level up after every 10 lines removed, which increases the drop speed. In *Sprint* and *Ultra* there is no level up, so the drop speed will remain unchanged throughout.



Adventure

Enjoy the story as you compete in Puyo Puyo™ and Tetris® matches.

Map Screen

Use the World Map to navigate to the stage you want to play. Some stages form part of the main story, while others are “Practice Stages” that allow you to learn different techniques. There are also “Secret Stages” with surprise story elements for you to discover.



Stages yet to be unlocked are marked “?” and cannot be opened. You will need to clear other stages to unlock them.



Press the button marked *Shortcut* to navigate easily to distant areas of the map.



Dialogue Scenes

Select a stage to enjoy some witty repartee between the characters. Use the buttons marked to *Skip* or *Autoplay* the dialogue.



* Dialogue scenes that have already been viewed can be watched again via *Theatre* in **OPTIONS & DATA**.

Clear Conditions

Before a match starts, the clear conditions and rating standard are displayed. You will be awarded stars based on your performance. Earning stars increases your overall clearance level.

Skip Stage

If you fail to clear any stage, the *Skip Stage* option will become available in the post-match menu. Selecting this allows you to continue the story. Don't worry—you can come back and try again later!

Stage Clear

Clear a stage to increase playable characters and BGM tracks.

In addition, if you clear a *Skill Battle*, all of your characters will receive Experience and you can earn Item Cards too. Repeat the same stage as many times as you like—it's an ideal way to level up your characters!

Stages that offer Item Cards show a special icon.



Some matches begin with a *Mission*. Clear the *Mission* to increase the number of cards you can receive and their effectiveness.





Solo

Play the game by yourself using a variety of rulesets. See [MATCH RULES](#) for further details.

Mode Selection

For some rulesets, you can choose the Mode before playing:

Choose *Battle* to play a single match against up to three CPU players. Select *Endurance* to see how many CPU players you can beat before losing.



Players

Set the number of CPU players from 1 to 3.



Character Select / Team Select

Choose a character and playstyle (Puyo Puyo™ / Tetris®). In *Skill Battle* you will need to form a team, or select one of the teams you made earlier in [OPTIONS & DATA](#).



Puyo and Tetrimino release patterns vary depending on the ruleset. You can check the pattern for each character via the *Character Select* screen.



Pre-Play Settings

Various settings are available at the standby screen immediately before a match commences. Settings vary depending on the ruleset.



Customize

Set the wallpaper and BGM for the match.

Handicap

Set the match difficulty for each player to your preferred advantage or disadvantage. Settings range from *Sweet* to *Spicy!*

Game Settings

Set additional game rule parameters.

Results Screen / Save Replay

At the end of each game, you receive points based on your performance. Points can be used as in-game currency at the *Shop*.



If a replay slot is available, or you select *Save Replay* from the post-match menu, a match replay will be saved for you to review at a later time. These are accessed via *Theatre* in *Options & Data*. You can also share it with the world via *Online*.

* Replays cannot be saved in *Endurance*.

* A total of 50 replays can be saved across all rulesets.



Multiplayer

A simple multiplayer mode for up to 4 players competing simultaneously, or up to 8 players competing in pairs tournament style.

Nintendo Switch™

For Nintendo Switch, first select *Single Screen* or *Local Wireless*.



Single Screen

Use multiple controllers to play on a single console in *TV mode* or *tabletop mode*.



Please prepare each of the following:

- Nintendo Switch Console: 1
- This Software: 1
- Joy-Con / Nintendo Switch Pro Controllers: 1 for each player (max 4)

Local Wireless

Each player uses their own console in *handheld mode*.

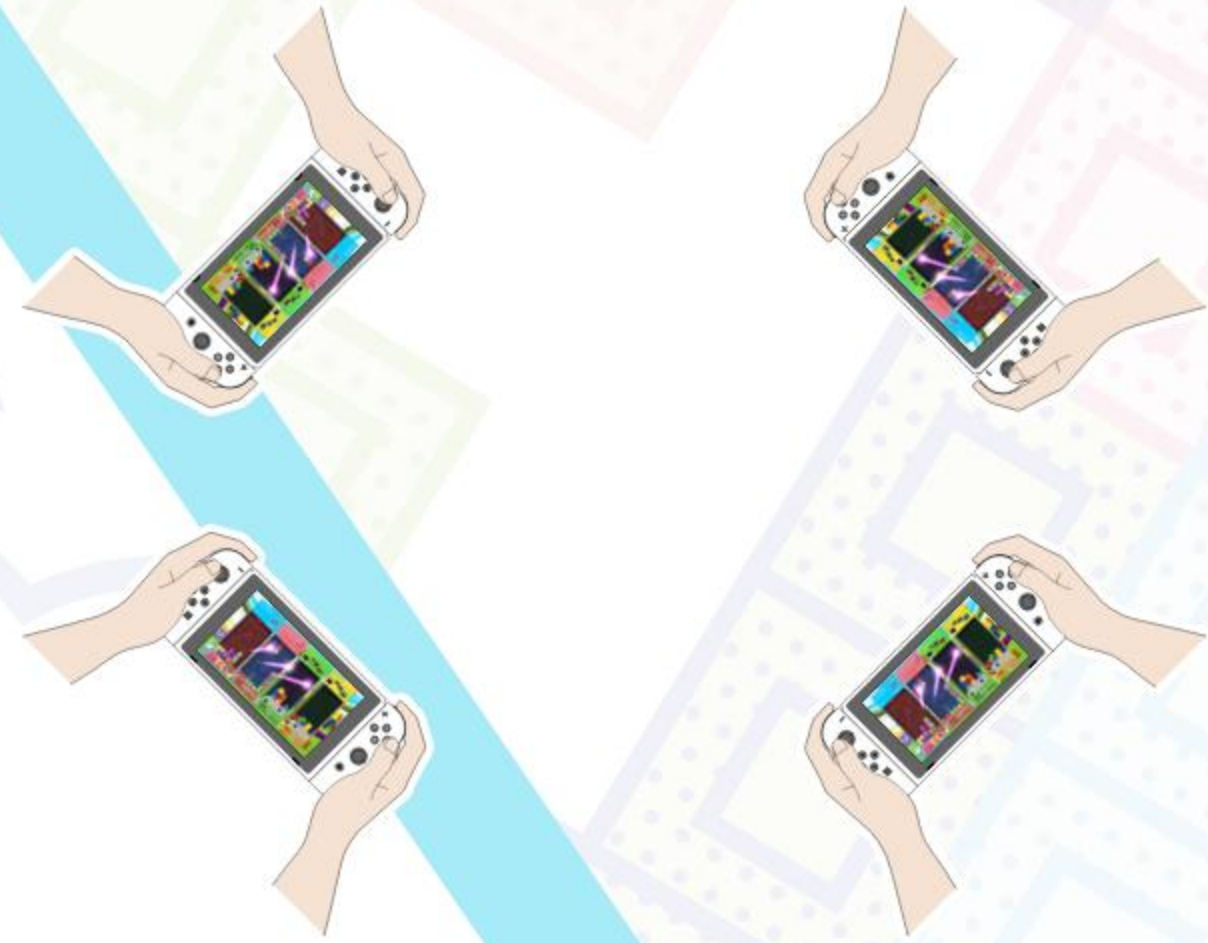

Please prepare each of the following:

- Nintendo Switch Console: 1 for each player
- This Software: 1 for each player

Play Boss Raid via Local Wireless

On the Nintendo Switch™ version, select *Skill Battle* during *Local Play* and you will be given the option to play **BOSS RAID**. The game content is identical to the game selected via *Online*.

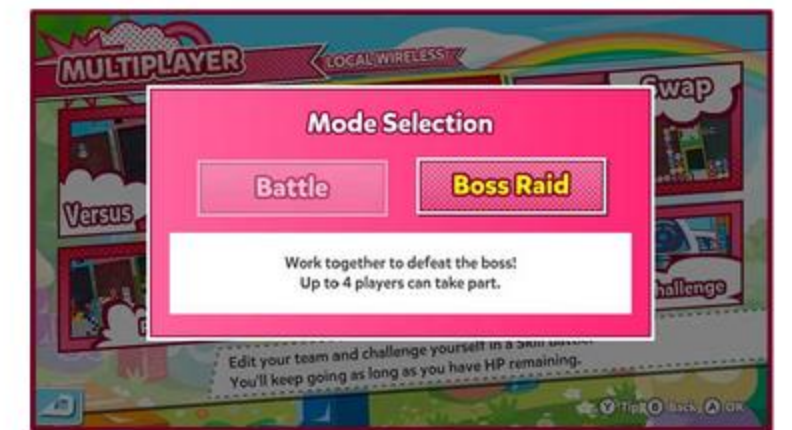

Select Rule

Choose the ruleset that everyone will play. There are a total of seven rulesets to choose from.



Mode Selection

Select the match format. Choose *Battle* to play one round with 2 to 4 players. Choose *Tournament* for a tournament style playoff for up to 8 players.

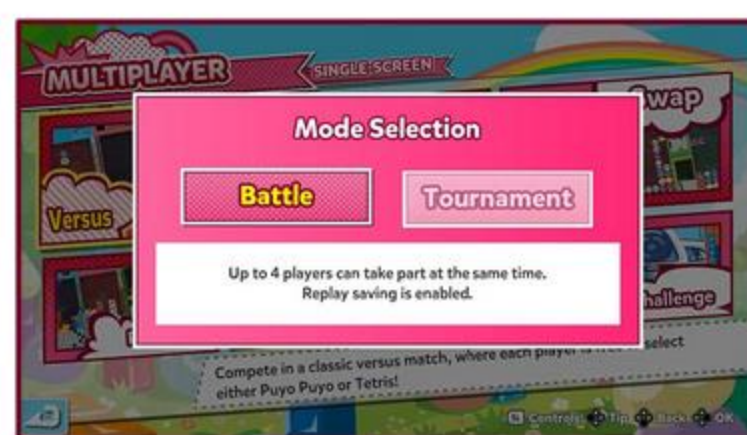

Tournament

Players compete in pairs. The winner of each match continues to the next round, while the loser drops out. Player icons are arranged to form an easy to read tournament chart.



Number of Players

Choose the number of players. *Battle* is for 2 to 4 players. *Tournament* is for up to 8 players.

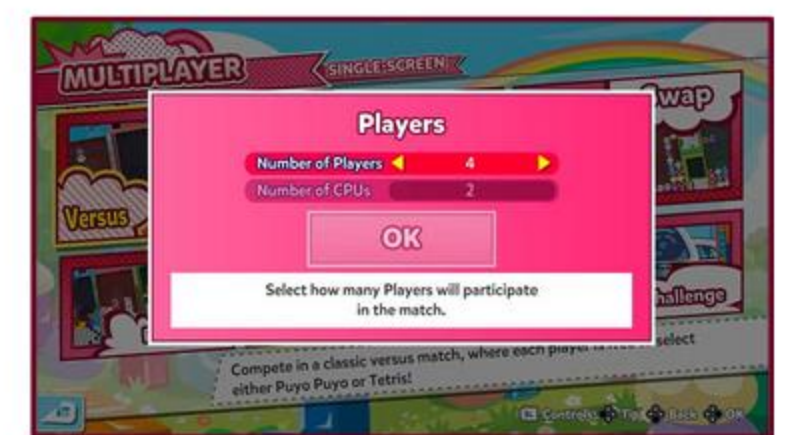

* In *Tournament*, only two players play simultaneously, so up to 8 players can join using just two controllers.

Team Battles for 3-4 Players

With 3 or more players, you have the option to form teams. Simply choose a team mark (♠/♥/♣/♦). Any other players that choose the same mark will become your teammates!



Character Select / Team Select

Choose a character or a team. In *Versus*, *Party*, and *Big Bang* you can also choose a playstyle (Puyo Puyo™ or Tetris®).





Options & Data

Check out your stats, change game settings, and edit your *Skill Battle* teams. You can also watch your match replays here.

Player

Choose an icon, character, and customization. The character selected here will become the default selection at the *Character Select* screen prior to matches.



Edit Team

Edit up to 10 teams to use in *Skill Battle*. For each team select a playstyle, three characters, skills, and Item Cards.

Unlock playable characters and acquire Item Cards in **ADVENTURE**.



Character Info



1 Experience and Level Information

- Current Level
- Experience required to next Level
- Experience attained so far

Characters are leveled up in *Skill Battle* stages of *Adventure*. Level up characters to increase status and skill rank.

2 Status

Status displays the values of each parameter for the selected character.

- Attack: Affects ability to attack opponents
- Defense: Affects damage from incoming attacks
- Recovery: Affects level of HP recovery over time, as well as speed of MP recovery

3 Auto Skill

These skills are used automatically without user interaction.

4 Special Skill

A skill that can be unleashed during a match. At first only one is available, but as your characters level up, available skills also increase.

5 Skill Info

Press the button marked *Skill Info* for a full explanation.

Item Cards

Depending on the card status, some or all parameters will increase i.e. HP, MP, Attack, Defense, and Recovery. Even cards of the same type can have very different statuses.

Cards with a special status are marked with a star. Equip several of these for a bonus multiplier effect.



Save a card to your favorites to prevent accidental deletion. Equipped cards also cannot be deleted.



Shop

Purchase customized items, character voices, and player icons using the points you earned through gameplay.



* Purchased character voices can be set at the *Character Select* screen.

Theatre

Listen to in-game audio, watch previously viewed dialogue scenes, and review your saved match replays.

Stats

See your player stats for each game rule and Collections of challenges to complete over the course of the game.

Options

Change basic game settings, button assignments, and choose which rulesets to include in *Puzzle League*.

If you're having difficulty identifying individual Puyos and Tetriminos, you can adjust the screen colors by switching the Filter to ON as shown screen right.



Online

Connect to the Internet to play against friends and other players from around the world, and upload match replays. The first time you select *Online*, you will be required to enter your regional settings. These can also be set via *Options* in **OPTIONS & DATA**.



Caution

- No guarantees are made about the quality of your network connection. Delays, dropped data and disconnection may occur depending on your and your opponent's network environment. SEGA accepts no responsibility for any trouble or damage due to connectivity issues when using the network functionality.
- This service will be available for a set period of time, and may be terminated at any time without notice.
- During online play, the user name registered to your console will be visible to others. Please avoid registering personally identifiable information such as your real name or telephone number, and names that are likely to cause discomfort to others.

Precautions when connecting online

Nintendo Switch™

To play against other Nintendo Switch users from around the world, you will need the user account that is registered to the console to be linked to a Nintendo Account, and be a **paid member of "Nintendo Switch Online"**.

PlayStation®4

PlayStation®5

To play against other PlayStation®4 and PlayStation®5 users from around the world, you will need to be signed into PlayStation™Network and also be a **paid member of "PlayStation®Plus"**.

Use of PlayStation™Network requires internet access, and an account for PlayStation™Network must be created and used in accordance with the terms and conditions. Parental or guardian permission is required to create accounts under 18 years of age.

Xbox One

Xbox Series X|S

To play against other Xbox One or Xbox Series X|S users from around the world, you will need to be a **paid member of "Xbox Live Gold"**.

Puzzle League

Play against other players from around the world. Win matches to raise your rank and enter the higher league contests.

First choose a league.

Puzzle League	Play <i>Versus</i> , <i>Fusion</i> , <i>Swap</i> , <i>Party</i> , or <i>Big Bang</i> and compete to win! Choose your preferred playstyle (Puyo Puyo™ / Tetris®) depending on the game settings.
Puyo Puyo League	Play exclusively Puyo Puyo battles using <i>Versus</i> settings.
Tetris League	Play exclusively Tetris battles using <i>Versus</i> settings.
Skill Battle League	Play exclusively in <i>Skill Battle</i> settings.

Find Opponent

Select this and an opponent will be matched automatically. While in the standby area, you can choose the match settings, check your opponent's profile, and leave a pre-for matted greeting. When both players have pressed *Ready*, you will be prompted to select a character before the match begins. At the end of the match, you can choose another opponent or exit the mode.

Rankings

See the *Top 20 (World)* rankings as well as your own position.

Leagues

Use the *Opponent Net Speed* setting to choose an opponent based on how smoothly the match will proceed. In *Puzzle League*, you can also choose an opponent by rule setting.

Rate

Your rate will go up and down as you win and lose matches. The higher a player's rate, the stronger they are. Opponent matching aims to match players of comparable rates.

- * If you turn off the power to your console or disconnect from the Internet during a match, it will be recorded as your loss and your rate will decrease as a result. Consider yourself warned!

Promotion and Demotion Battles

Win a streak of matches and you might find yourself in a Promotion Battle. Win to gain entry to a higher league. Similarly, a losing streak may eventually lead to a Demotion Battle. Lose that and you'll find yourself in a lower league, with all the shame that entails.

Free Play

Pick the rules that you want to use and join any session that interests you. This mode will not affect your rate or ranking. Begin by selecting a game rule setting.



Tournament

Room Select

Align the cursor with a room to see information such as player count and settings. Choose a room to proceed.



PlayStation®4 and PlayStation®5

For both PlayStation®4 and PlayStation®5, select the room type or player count to enter.

Create Room

Host your own room. Set the playstyle, connection speed, and whether or not to apply a password, then press *OK* to proceed. Complete the various settings and press *Create Room* to move to the *Game Lobby*.



Game Lobby

Entries are accepted at the *Game Lobby*. When everybody has pressed *Ready*, you will proceed to the *Character Select* screen. If there are 3 or more players, you will also proceed to the *Team Select* screen.



Spectate

Watch matches played by other players in *VS* and *Skill Battle* modes.

- * Spectate is only available in rooms where *Allow Spectating* is set to *Enabled*.

Spectator Lobby

Select a Room to display the ruleset and player information.



PlayStation®4 and PlayStation®5

For both PlayStation®4 and PlayStation®5, select a player count to enter the Spectator Lobby.

While You Wait...

As you wait for the match to begin, you can send players messages of encouragement! The match will begin after the players have each chosen a character.



Watch the Match

Watch the selected match unfold! Information on Chains, Offsets and other actions will be logged to the side of the screen. Press and hold the cancel button if you wish to exit the match.



Results Screen

When the match ends, the winner and match deciding factor will be displayed.

Replays

See replays of the top ranking *Puzzle League* matches, as well as those of friends.

Watch Replay

Choose a replay to watch. You can also check the player profile and jump straight to highlights such as chains and offsets.



- * You cannot jump to highlights in *Skill Battle*.

Upload Replay

Post a replay of one of your own matches. Simply choose a saved replay and select *Post* from the Replay menu.



- * Only one replay can be posted at a time. Posting a second replay will overwrite the first.

Join Friend

Join a Friend online and play together.

When you receive an invite from a friend, select *Join* to enter the room.



PlayStation®4 and PlayStation®5...

On PlayStation®4 and PlayStation®5, you can use the console's built in functionality to invite and join friends.
* *Join Friend* functionality was removed from the PlayStation®4 version with Patch Update 1.50.

Options & Data

As with **OPTIONS & DATA** in the main menu, you can check player stats, change game settings, and edit *Skill Battle* teams here, as well as watch saved replays and other visual entertainment treats.

Challenge Ranking

Check your ranking from **CHALLENGE** in *Solo*. Choose a ruleset to see the *Top 20 (World)* ranking as well as your own position.



Boss Raid

1 to 4 players battle against a Boss character.

Raid Screen

Each player selects a Team and plays together against the Boss. Reduce the Boss's HP to zero to win.



1 Teammates HP / MP

Keep an eye on your teammates' statuses.

2 Chance Time Conditions

Fulfill the conditions to enter Chance Time! As with *Big Bang*, this is your opportunity to inflict major damage!

3 Attack Damage

The amount of damage dealt to the boss by you or your teammates.

Join Forces Against the Boss

Some skills such as HP recovery and status effect recovery are shared with other players. Check the HP and MP of your teammates to make sure you use your skills optimally.



When HP Reduces to Zero

If everyone's HP reduces to zero at the same time, then the raid is lost. You can choose to try again, return to the lobby, change opponents, or quit the game.





Lessons

Everything you need to know from basic play to more advanced techniques.

Learn basic instructions of *Puyo Puyo™*, *Fusion*, *Tetris®*, and *Skill Battle*. For *Puyo Puyo* and *Tetris*, you can also try your hand at solving *Problems* that have been set up!



Beginner

Lessons aimed at beginners playing for the first time. This covers the basic rules.

Intermediate

Lessons aimed at those familiar with the rules, but wanting to up their game with a few advanced skills.

Advanced

Lessons aimed at seasoned professionals. Not for the faint hearted!

Problems

There are 100 problems to solve for each playstyle. The pencil icons show the difficulty level.



For some problems, press the button marked *Show Guide* to reset the Board with added reference markers.

