

**80**  
PULSATING  
PAGES!!  
STILL ONLY  
**70p**

# COMPUTER EXPRESS

FIRST NEWS • FIRST REVIEWS • BEST BUYS • YOUR WEEKLY GUIDE

## THIS WEEK

**AMIGA**  
A 32-bit version of the 2000 is in the pipeline

**PC**  
The talking Tandy and the tiny Texas Travelmate

**ATARI**  
Fancy upgrading your ST to a 12Mbyte 68030?

**MACINTOSH**  
Apple announces SE30, IICI and Portable price-cuts

**CONSOLES**  
Sega's Game Gear's here!



## DTV

All you need to become a Desktop Video Director

# HACKING A BANK?

Scare story blackmailers haven't a hope say top security experts

## PLUS 48 PAGES OF BARGAINS

**NEW AMIGA ASSEMBLER PAGES 2**

**ATARI'S PRAYER**

ALL IN WHOLE WIRE WORLD ON PAGE 32 AND STARTING THIS WEEK

**THE EXPRESS EXTRA SERVICE GUIDE TO BARGAINS**

**FREE! Reader Ads Order Form**

**SHOPPING EXPRESS**

THE WEEK'S BEST DEALS TO YOUR BARGAIN AND MORE

**CONTENTS**

AMIGA: 10-15  
 ATARI: 16-20  
 APPLE: 21-25  
 COMPAQ: 26-30  
 HP: 31-35  
 IBM: 36-40  
 INTEL: 41-45  
 MOTOROLA: 46-50  
 SONY: 51-55  
 TANDY: 56-60  
 TEXAS INSTRUMENTS: 61-65  
 TRUST: 66-70  
 XEROX: 71-75  
 ZENITH: 76-80

**TERMS AND CONDITIONS**



**Turtally Wonderful?**

First screenshots of Imageworks' Xmas No.1

## DPaint 2 The state of the ST art!



# frontend

edited by Colin Campbell

## Divine intervention

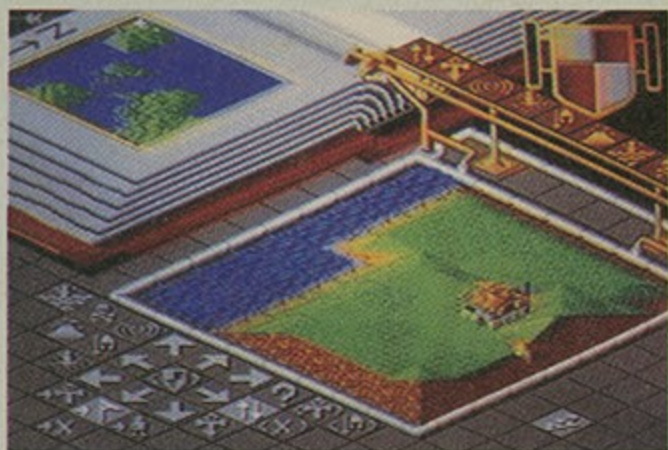

If you've played *Populous*, the 'God simulation', you'll probably be quite keen to hear all about a sequel, scheduled for release next year. Frontend can reveal a few snippets of heavenly information concerning *Populous II* from Bullfrog. We're not talking about *Powermonger*, the new world domination game, we're talking about the actual, bone fide, completely legitimate, 100 per cent kosher *Populous II*.

Instead of the ability to choose from half a dozen divine functions (earthquakes, pestilence, that kind of thing), you'll be able to pick from up to 30. There's also some great graphical representations of cities being levelled and to top it all, there's an insidious new enemy.

This isn't just a case of pitting your wits against good or evil Gods. There's also some amoral types who are entirely unpredictable. You'll have to get them around to your way of thinking.

*Populous II* will be published by software heavyweight Electronic Arts. But programming team Bullfrog is looking for a new deal. The firm's Peter Molyneux said: "We're looking around at different deals at the moment. We could stay with EA or we could move on." But he ruled out the possibility of going it alone as a fully fledged publisher. "We write computer games. We're not businessmen," he said. ■

● Atari is planning an outdoor poster advertising campaign for its handheld Portfolio machine. The cheeky ad states: "Now it is possible to get to work on British Rail."

● A updated version of Goliath Games' international football management game is to be launched early next year. *Tracksuit Manager Update* will be the same as the original, but will feature 1990 players and statistics. A domestic league version is also planned.

● The third 16-bit Computer Fair will be held at The Novotel, Hammersmith, London, from 4-6 January, it was announced last week. We'll keep you updated on all the salient details as they're announced.

● Elonex has announced price cuts on its range of colour 386 PCs. Best buy is the 40Mb PC 386B/25 Compact with VGA monitor, it now costs £1,645 - down £250.

● The University of London may have to shut down its computer centre because of lack of funds. The installed supercomputers are used for research and scientific purposes. Cuts have caused the University major problems across the board. The computer centre cannot survive on less than £2.6 million a year, but the budget allowed for the department is only £1.5 million. ■

## Craving for Cray



Under normal circumstances, you'd have to pay about £1million for a computer capable of 80 million floating points per second. A nice little number from Cray would just about cover your requirements.

However, PC owners are to be treated to a number crunching demon which can not only handle this kind of processing, but also packs a machine with a blistering 40Mhz of speed and a cool 32Mb of memory.

The Number-Smasher-860 from Microway is, as far as we know, the most heavy duty accelerator board available. It's perfect for numerically intensive applications such as financial analysis, 3D graphics, CAD and engineering simulation.

You can plug it into any ISA slot on a 286 or upwards and it costs a two hundredth of the price of a Cray - £5,000.

We reckon it will do some pretty amazing things to *Stunt Car Racer* as well. Call 081-541 5466. ■

## Well punk, do you feel lucky?

This man is a great cop. Harry Callaghan can waste two stick-up kids at once while still munching a chilli dog. He can put a neat hole in the middle of any psycho's head from virtually any range. And he growls great lines like: "A man's gotta know his limitations."

Who remembers that bit when he corners the nasty villain and, in all the preceding excitement, forgets if there are any bullets left in his gun? The crook just knows he can get away if all the bullets are gone. But he's also aware that Callaghan is holding a Magnum 44, the most powerful handgun in the world. He's guessing that if he tries anything cute, Callaghan will need only one slug to blow his head clean off. Not surprisingly the outlaw decides to take his chances in the local penitentiary.

What has all this to do with computers? Simple. Mindscape has picked up the Dirty Harry character licence for a new game due to be launched in the spring. Nobody knows what the game is all about but, at a rough guess, it will be delightfully violent. ■

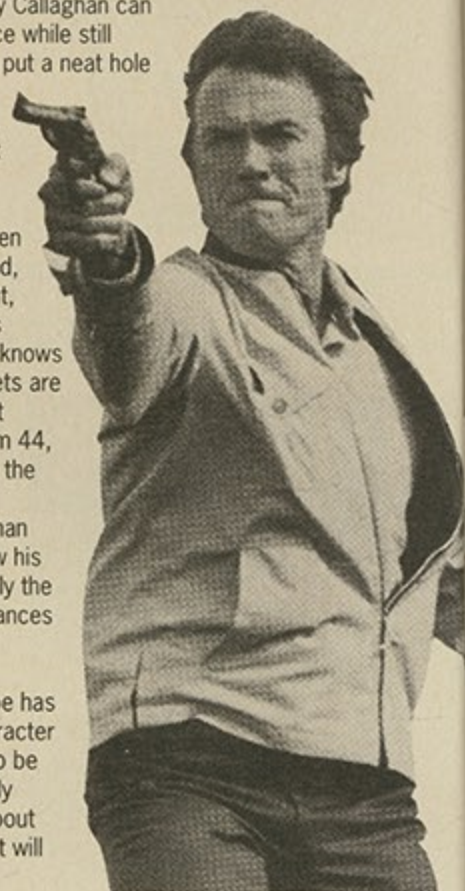

## INTELLIGENT TV ARRIVES

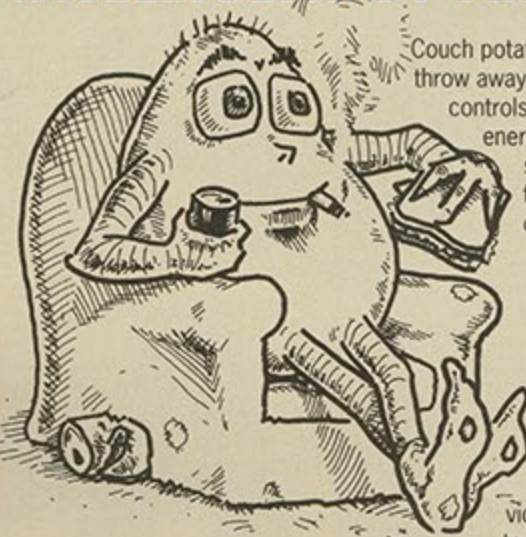

Couch potatoes get ready to throw away your remote controls - if you've got the energy - because a TV set that does the thinking for you is on the way.

The intelligent television will keep track of what you watch, scan listings and select suitable programmes, thanks to digital video compression technology,

demonstrated for the first time in Europe at the International Broadcasting Convention in Brighton.

The TV, currently in development in Japan, can build up a viewer profile which would be 70 per cent accurate. It can either sound an alarm to tell you a selected programme is on, or record it, cutting out the adverts at the same time.

To play back the recording, the hardened couch potato still need not worry about the strain of moving his fingers. The Japanese are working on video recorders that are voice controlled.

Meanwhile, a Japanese businessman - worried about the effects television has on children - has developed a device to limit the amount of time they can watch the set.

Parents decide a suitable length of viewing time, then set it using an electronic card inserted into the remote control. At the end of the designated time, the device turns off the television. ■

## Stupid BB offers kids bomb tips

Youngsters are reported to be downloading software from a bulletin board which details the methods for making Napalm and other explosives.

Last week's *News of the World* carried a story concerning a bulletin board based in the Maidstone area of Kent. Amiga owners could download this particularly horrible little program. It includes the recipes for eight explosives as well as "tips" on how to shoplift successfully.

Police were alerted by Chatham dealer Mike Lane. He said: "This is really nasty. I've never seen anything like it. These bombs are easy to make and the chemicals are not difficult to get hold of. It is coming up to bonfire night and if some impressionable youngster gets hold of this you've got a mega problem." ■

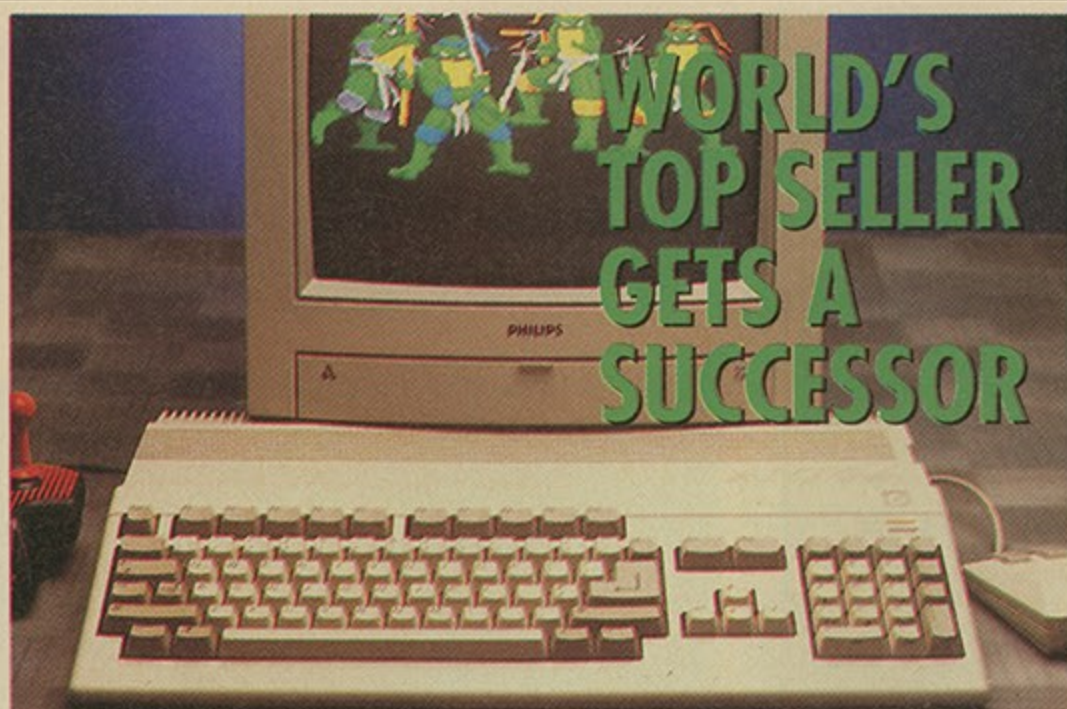

Philips has launched a new version of its extremely popular CM8833 colour monitor. The original is claimed to be Britain's (and the world's) best selling monitor with sales of 200,000 here and 2 million in total.

It's especially popular with ST and Amiga owners - Atari and Commodore have bought thousands from Philips in the past and badged them with their own logos, as have a whole host of IBM compatibles manufacturers.

Curiously, the CM8833 Mark II will be much the same as the four-year-old original, with changes

restricted to aesthetics. It's still a 14-inch colour CGA but the new model looks better and conforms to all manner of European safety standards.

It still costs a reasonable £269.99 with a TV tuner optional at £64.99. It has a TTL digital and RGB analog signals, CVBS input for video signals, stereo sound, a screen resolution of 600 x 285 and line frequency of 15.6 KHz.

A spokesman for Philips said: "We just didn't think there was much point in making too many changes. But we felt it important to get in line with the new European safety standards." ■



## BARK TO THE FUTURE

The European Parliament last week laid down a proposal to register every dog in Europe on computer. If the registration plan passes into law then 36 million dogs could be carrying ID in the form of a tiny microchip inserted in the scruff of the neck. The info will be held on central computers in Strasbourg.

It is hoped that this will help combat the continuing spread of rabies and the difficult problem of strays. ■

# Justice in the courts

Computers have been enlisted by Wimbledon's All England Tennis Club to ensure everyone has a chance to see the world's greatest players perform in the game's most prestigious tournament.

In the past, buyers of Wimbledon tickets have had to simply fill in an application form and enter a draw. The trouble with this very fair system is that many lucky winners can't resist selling their tickets to the wealthy for a lucrative profit. This makes a seemingly democratic system

highly plutocratic.

Now the club has decided to log all the names of ticket holders onto a computer database. A series of spot checks at tournament time will make sure the original ticket buyers haven't been replaced by different people. Anyone attempting to break the rules will be asked to leave, which will be just a tad inconvenient for those people who can afford to spend hundreds of pounds on one illegitimate ticket. What a shame... ■



# CONTENTS

## FEATURES

**Computers in the high street**  
Separate the good from the bad - page 4

**DPaint for the ST; the review**  
What makes it so wonderful? What makes it so interesting? Find out on page 74

## REVIEWS

**At last it's DPaint for the ST**  
A new desktop publishing package for the PC offers power without the price - page 74

**Now copy that!**  
Canon's new computer interfaced colour photocopier causes a stir - page 76

## EVERY WEEK

**Games Week**  
News, reviews and tips - page 67



**The Console Zone**  
Playing tips for your console favourites, plus news - page 72

**WIN a laser printer**  
... and DPaint - page 78

**News** 4-9  
**Opinion** 10  
**Letters** 14

## SHOPPING EXPRESS

<b>Amiga</b>	<b>18</b>	<b>PC</b>	<b>24</b>
<b>Archimedes</b>	<b>19</b>	<b>Spectrum</b>	<b>25</b>
<b>CPC</b>	<b>20</b>	<b>ST</b>	<b>26</b>
<b>C64</b>	<b>22</b>	<b>Mac</b>	<b>27</b>



• Play Shadow of the Beaston your cpc

<b>Whole Wired</b>	
<b>World</b>	<b>32</b>
<b>PD Column</b>	<b>62</b>
<b>Circuit City</b>	<b>35</b>
<b>Centrefold</b>	<b>36</b>
<b>On-line</b>	<b>56</b>

**C**hristmas is coming, and this is the one time of year when you guarantee that computers will be bought in vast numbers by people who know very little about them. Express hit the streets to find separate the good from the bad.

Shops will be piled high with all manner of computers, handhelds and consoles this Christmas. On the one hand this is good news for you the buyer. On the other it can mean that the shop assistants will have had so much hardware chucked their way that they will hardly know their GX4000s from their Amiga 500s.

However, there is one thing of which you can be reasonably certain, the hardware with the best mark-ups will be pushed most firmly at you. So, whether you are buying for yourself, your little sister or your Granny you should read the following guide.

Are the High Street Stores better? or worse than the independents? Does quantity negate quality or are the big chains finally getting their acts together. Do these people know what they're talking about? And how should you deal with them? All these questions are addressed.

## Don't believe the hype

The High Street stores, those big names we all know so well, have only relatively recently moved into selling computer hardware. This fact should be borne in mind when opening the glass doors with your cheque book or credit card in hand. To a great number of shop assistants (and managers for that matter) a computer is something to sell in the same way as a dishwasher or a toaster.

All of these products have been sold to the store by reps and various deals have been struck between the two. This is why, for example, Rumbelows will sell you an ST at £299 and an Amiga at £399 while Comet will sell them both for £399. Different chains will have received different deals on these packs. So, the truism 'shop around' holds more than true.

**Question one** for you to ask is "What exactly am I getting?". If this befuddles the assistant, simply ask him or her to get hold of the details which will have come with the machine. If that is not available then it's time to leave the shop; the mere suggestion of this is normally enough to get some action.

**Question two** is simple enough as well "Can I see it in action?". Whether the shop is busy or not,

don't be afraid to ask this one. Shop assistants are normally difficult enough to track down, so once you've trapped one, he or she is yours.

This Christmas look out for the following line "This one's called *Shadow of the Beast II*" it's great, "just look at the graphics." The Beast you will see running on shop Amigas is a demo. Get them to run some other games, maybe even a word processor if you have the time.

**Question three** only comes into play when you've decided on the machine you want to buy and they have brought it up from the warehouse all boxed and sucking the money from your pocket. The question is "Can I see this one working as well?" This is normally a show stopper, but it is important that you ask it. The machine which has been up and running in the store is not the same as the one you are going to get out of the box. If your chosen machine doesn't work exactly, get them to bring you another one and then try that.

**Question four** comes into play before you part with money. It is "Does the shop offer a guarantee as well as the manufacturer?" Get the guarantee signed in the shop. The machine will have been out of the box so this shouldn't be difficult. If it is, then don't buy.

Computers in the high street - the

# WHAT'S IN



## Who's selling what

### COMET (also DEBENHAMS)

Comet tends to push the more expensive consumer durables such as washing machines and NICAM stereo TVs. A range of computers and consoles are available even if the service is not particularly excellent. Try this "Will the Spectrum +3 last?", "Well, they do bring it out every Christmas so I suppose so." These are the machines which we know they stock.

C64  
Spectrum +3  
Spectrum +2  
Amiga 500  
Atari ST  
Sega Master

### RUMBELOWS

Rumbelows is back in the computer market with "a finger in the air". Having pulled out a few years ago it is now restocking its stores countrywide. This is what Rumbelows will be stocking around the country for Christmas:

C64 (Nightmoves package)  
Amiga 500 (Screen Gems)  
Atari ST (Discovery Pack)  
Nintendo (Action pack, Mutant Machine Pack)  
Gameboy  
Lynx  
Spectrum +2

### TANDY

Known for its own range of business machines and portables, Tandy has a reputation for being more than just a 'box shifter'. The range it has on show is as follows:

C64 console (Nightmoves pack)  
Atari ST (Discovery Pack Plus. This is exclusive to Tandy and includes the following additions to the standard Discovery pack: a joystick, *Music Maker*, *Afterburner*, *R-Type*, *Gauntlet II*, *Super Hang-On*, *Atari Grand Prix*, *Microprose Soccer*, *Eliminator*, *Nebulous*, *Pacmania*, *E-Motion*, *Crack'ed*,

*Bomboozal*, *Thunderblade* and *Road Blasters*) it retails at £399.99 instead of £299.99.

The Spectrum +2.

### DIXONS

A wide range of computer hardware resides in any Dixons you could care to mention. The following are definitely available.

Amiga 500 (Screen Gems pack)  
Atari ST (Discovery pack)  
C64 (various packs)  
Spectrum +2  
CPC 464+  
CPC 6128+  
Nintendo Entertainment System (Mutant Machine pack, Action Pack, Deluxe Pack)  
C64 console  
Sega Master system  
Sega Mega Drive  
The Gameboy  
The Lynx  
Olivetti PCs  
Amstrad 1640HD  
Amstrad 286HD  
Amstrad Generation 3 PCs

### BOOTS

Boots press office informed is that "we won't stock computers, but for Christmas will have the following" this does not bode well for service and technical knowledge from the assistants. We were also told that the NES was a handheld. Anyway these are the machines available from Boots:

Nintendo (Mutant Machine, Action pack)  
Amiga 500  
Gameboy

## Credit where credit's due

All of the big chain stores offer credit. This is how they make their money. There are several questions to be asked here.

**Question 1:** Is there a penalty clause relating to early repayment. Some credit policies want you to take the full period to repay your purchase. The reason for this is that every month you're repaying makes the store more interest. If there is such a clause then move on.

**Question 2:** Is there an insurance clause? This is a matter of choice and it normally costs a few pounds on the top. What it means is that if you are made redundant or fall ill your payments are covered.

**Question 3:** What is the APR% (Annual Percentage Rate)? This is the amount which will be added to your repayment. Check this even if there are signs in the shop screaming "0% Interest".

**Question 4:** When was the last time the APR changed? If it came down recently you're in luck. If it hasn't changed in the last five months, find out why because interest rates have.

A final tip is to check the rates before buying and then compare them to the credit card companies. ■

t — the good, the bad and the . . .

# IN STORE?

By Tim Smith



## RUMBELOWS



• Keen on the Commodore at Rumbelows

The service in Rumbelows was more prompt and even friendly. We were immediately lead to the Amiga and it transpired that the assistant owned one. After five minutes raving about it we moved onto the ST. Two second later we were back on the Amiga because, "The ST's got a bad sound chip."

The patter relating to the Screen Gems pack (although this name was never mentioned) was clean, with a mistake when it came to Workbench "very useful is Workbench... er, for graphics"

We asked why there was £100 difference between the ST and the Amiga. We were told "It's a better machine." Very subjective indeed, especially because we had been told nothing about the ST.

We asked about getting parts for the machines "Commodore parts are very easy to get hold of." He could not be budged on any other machine.

Consoles were swept aside [the Mega Drive was definitely called the '16-Bit!'] with the same disdain as anything else un-Amiga. So, with the feeling that the salesman had been on a commission from Commodore we moved onto the next shop.

**A**rmed with hidden tape recorder and camera we visited three stores local to us. The aim here was to discover what level of service and technical knowledge you could expect when shopping around.

Happily this did not prove as disheartening exercise as last year's which gave the immortal quote about the C64 from Laskys "Yes there's loads [of software] for it - and then you can run Vic 20 games on it too - you can use any Commodore games as long as they're lower than 64." It appears that this year the big chains have started to employ people who have a rough grasp of the subject.

## DIXONS

After spending five minutes waiting to be served, a managerial sort wandered over.

We asked about the Amstrad console. We were told "It's only been out a few weeks, it's brand new. But the best bet is the Nintendo to be honest with you. It's got the Turtle game which is all the rage and it has the widest range of available software... Of these sort of things, the Nintendo is the most popular by a very long chalk" Not at all true as Sega and Atari would most certainly agree.

We asked where Nintendo came from. We were told "I don't know, I think they're probably made in Japan, but they are an American company." Wrong, and bodes ill for product knowledge

We asked about the difference between cartridges and disks. We were told "... cheaper than disk", while this true in some cases, it is far from so as a generality.

We asked what the difference was between a console and an Amiga " These [consoles] are 80 quid, the Amiga's £400" That wasn't exactly what was meant and the price tags on the hardware had



• At Dixons Turtles were 'all the rage'

already answered the question. Still it showed where the thrust of the sale lay.

We asked the difference between the ST and the Amiga. We were told "You'll find it easier to get software for that one [the Amiga] and the graphics are certainly better" Totally wrong on the first count. Dubious in the extreme on the second.

With that we left the shop.

## COMET

We visited two Comet stores; one was housed in Bristol's massive Debenhams, the other was a dedicated shop in Bath. Neither were encouraging. The actual displays were poor, verging on the abysmal. In the Bath shop, the hardware on show was tucked away in a corner and comprised a tired looking Spectrum +2, a moribund looking +3, an Amiga 500, a Sega Master system, and a C64. The Debenhams office had the same plus a Mega Drive (called a 16-Bit). Attracting the attention of assistants in both stores entailed walking over to some more expensive gear such as a washing machine and then leading them back.

The opening line in both places was a simple "I am looking to buy a computer for my brother." The Debenhams response was a tired run around of the C64 and the Sega Master System.

We asked about memory. After an impressive sounding start, the assistant started to waffle "With the Commodore you get 64k of memory. A 'k' is eight bytes, a byte, er..." Generally, and even if it wasn't service with a smile, we were lead around the small range of available hardware in some detail.

The Bath branch was a different story and serves to illustrate the fact that while chain stores rave about training, countrywide shop similarity and homogeneity overall, it's just not true. Every store is different.

The service was distinctly surly, verging on the "What are you doing here at all?" Product knowledge was poor. Take these examples:

Of the Spectrum we were told "You won't get as many games as the rest of them." Games for the Speccie are more widely available than posters of Gazza.

How many colours do you get on screen with the

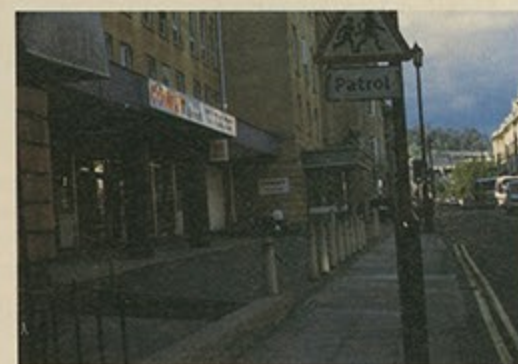

• A byte confused at Comet

Spec "It depends." When again prompted the assistant looked dolefully at the monitor, a TV, and obviously did not have the slightest idea.

We asked for a demonstration, the disk was missing, or it had been wiped, he wasn't sure. When we tried to extricate information relating to other machines this happened:

The Sega Master system "It's a console"

So what's a console? "That [the master system] is"

Will the +3 last "Well they bring it out every Christmas." Lack of product knowledge to say the least.

The Amiga "It's more expensive, but has more bits"

So, what's a bit? "Er...."

The ST "It's roughly the same as that [the Amiga]"

So, with the idea that we had been served by a person with more of an interest in NICAM stereo than computers, we left.

It is a sad fact that the small, independent computer shops suffer at this time of year. Price is a premium and the chains can afford to undercut the indies.

Don't let this put you off, however. There are two hard and fast facts in computing life: firstly, crashes always occur before you back-up, secondly, independent dealers give the best advice.

The same rules apply when shopping in either - ask exactly what you're getting. Get a demonstration of the machine you are going to take home. Check on guarantees.

### Shopper show twice a year

Even before this year's December *Computer Shopper Show* has opened its doors, plans are already afoot for not one, but two Shopper events next year.

Organiser Blenheim Database Exhibitions has announced a Spring Shopper Show in addition to the annual pre-Christmas event, once again sponsored by *Computer Shopper* magazine.

Blenheim says that the spring show has come about because of the huge success of the December event. It claims that this December's show is almost sold out already.

According to Michael Meakin, head of Blenheim, the spring show "will complete our plan to provide the trade and end-users with large spending events at the two most important times of the year for product launches".

Meanwhile, this December's event will be supporting a fundraising appeal by the Starlight Foundation, the excellent charity set up by one time *Dynasty* actress Emma Samms which grants the wishes of chronically and terminally ill children.

### Cyber conference

The second European Cyberspace Congress will take place in Amsterdam from March 10 to 12 next year, it was announced last week.

The conference will centre on the technical aspects of emerging virtual realities as well as focusing on the possibilities of art, philosophy and science in cyberspace.

Organiser Sala Communications says the attendance fee will be set at a relatively cheap £150, although the conference will be limited to 250 attendees.

For cyber fans it should be a must. Call 010 31 20203219.

### Micro sickness

The world can breath a sigh of relief. Students of medicine are soon to be given computers to experiment on instead of humans.

A new interactive training system has been launched which simulates sick patients. Student doctors must ask the computer the right questions in order to diagnose the ailment and then act accordingly. The patient will either improve or deteriorate (depending on how much the student has learnt).

Home users can already experiment with other people's health with Software Toolworks hospital simulation *Life and Death*.

## Will you let The Turtles into your home?

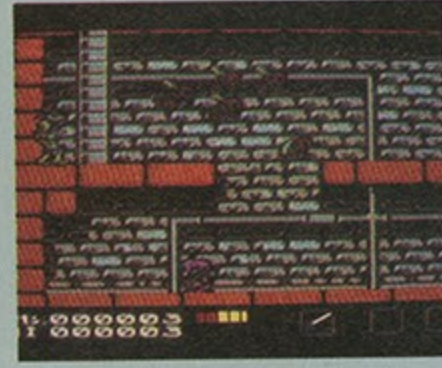

• From left: Imagework's Teenage Mutant Hero Turtles on the Speccy, C64 and Amstrad CPC.

Everyone knows the Teenage Mutant Hero Turtles are cleaning up everywhere else as well as the streets of New York. But will Imagework's forthcoming all-formats release make it to the coveted Christmas number one spot?

After receiving these exclusive screenshots, we have to admit we were a little unfair in our comments on the game in Issue 101 even though we did give it 2-1 odds - we'd only seen the inferior US version.

The European Turtles have had graphic and gameplay overhauls and will be hitting your screens in late November. So look forward to a full review then.

### Test drive a PC



• 3D Benchmark: A colourful way to test your system.

If you want to MOT your PC compatible or road test a system before deciding whether to buy it, then *3D Benchmark*, a new utility in the public domain could be just what you need.

The program, produced by New Dimension International, measures the speed of PC compatible VGA systems by timing one cycle of a continuous three dimensional demonstration, then calculating the average number of screen updates a system has achieved in one second. The result is expressed in frames per second (fps).

Among systems already tested, the Apricot Qi900 performed very well at 15.6fps whilst results at the lower end of the scale hovered around the 1.5-3fps mark.

Dimension hopes the program will establish a reference point for comparing systems and is actively encouraging free duplication and distribution.

The graphics have been created using the *Superscape* 'Alternative Reality' system, and are the same as in games like *Castle Master*.



• The Savage Empire: the stuff great B-movies are made of.

### The land that time forgot

Remember all those tacky British films in which Doug McClure did battle with dinosaurs that looked as if they had been made on *Blue Peter*?

If you do, then the premise for Mindscape's latest release in the *Worlds of Ultima* series will be very familiar.

*The Savage Empire*, an adventure-style game for the IBM PC, casts the player as the typical upper-crust British explorer attempting to solve ancient mysteries, whilst being hindered by a motley assortment of ferocious dinosaurs and bloodthirsty natives. A few scantily clad tribeswomen are also draped decoratively about the game.

Available from 25 October, *The Savage Empire* costs £34.99.

### Psion knocks pounds off laptops



• MC squared: new changes for Psion line-up

Psion was busy last week announcing comprehensive changes for its line-up of 'Mobile' computers.

Prices have been slashed across the range with the entry level MC200 down £50 to £495. The British company sees this as an important break through claiming that the machine is "the ultimate personal computer at an affordable price".

The MC400 is down from £845 to £695 with the top of the range PC compatible MC600 slashed by £200 to £1,295.

The range of Mobiles were launched in September 1989 to a favourable reception, but they have failed to spark the same enthusiasm as the handheld Psion Organisers which launched the company into the limelight during the late 1980s.

On the price cuts chairman David Potter enthused: "For the first time the man in the street can have a full function portable computer for less than £500."

Psion has further developed Version 2 of the system software for the range. All built in applications have been enhanced and extra help functions included. A graphic spreadsheet is now available for the 200 and 400 which allows Lotus 1-2-3 files to be imported.

### Tandy talking

Available now from Tandy is a desktop PC bound to appeal to users fed up changing disks all day long, and it talks to you as well.

The company claims the 1000SL/2 is the first PC to offer MS-DOS and Deskmate as integrated software, in ROM.

This means the user will not have to keep on inserting disks as software for letters, storage and retrieval of records, mathematics and seven other functions are all stored on hard disk.

The other unusual feature of the 1000SL/2 is that it can talk. The built-in three voice sound circuitry featuring DAC (Digital to Analogue Converter) allows for the recording, storing and playing back of sophisticated speech, music and sound.

The 1000 SL/2 costs £699.

Media scare unfounded: security systems are 'far too complex'

# BANKS SCORN HACKING CLAIMS

The Chartered Institute of Bankers (CIB), which represents Britain's high street clearing house fraternity, last week poured scorn on claims that hackers are wreaking havoc on sensitive financial computer networks.

And two of Britain's top hacking experts, Steve Gold and Hugo Cornwall, agree, insisting that banking security systems are far too complex for even the best hackers.

The *Independent on Sunday* reported on 14 October that the computer systems of four high street banks and one leading merchant bank in the City had been penetrated by a team of hackers intent on blackmail. Subsequently, *Independent Television News* and a number of quality daily newspapers picked up on the story.

But the CIB says that it is "extremely unlikely" that any hacker had broken into any one of the hundreds of networks used for financial transactions. Spokesman Alexander Moffatt told *Express*: "We spend more money on Information Technology and its security than any other business in the country. The electronic transfer of funds is as secure as it can be."

He said the banks do not fear the threat of hackers, but are spending millions of pounds combating internal fraud linked to computers.

## Investigations

The computer systems of high street banks and City financial institutions are a formidable barrier to even the most tenacious computer criminal. Not one bank has suffered at the hands of an external break-in of a computer system.

However, *The Independent* story claimed that a number of hackers had left messages inside computer networks, and had demanded "substantial sums of money" in return for their expertise and details of how they penetrated the computer systems. It is not known if the hackers are a gang, or if they are working independently.

The banks have not contacted the police, but are believed to have initiated low level investigations by freelance security firms.

So why are the banks claiming to be secure from invasions of their computer systems?

● Despite the public perception of a completely interlinked computer system, the electronic financial clearing systems are, in reality, a patchwork of computer programs which can perform only one function each, and are not connected to



● Britain's financial computer system is vast. It is used by millions of people every day, from mega-corporations to cashpoint card owners. Yet it is still too sophisticated for hackers to breach.

any other part of the network.

Unlike the computer networks of, say, university systems, banking systems are not designed to be informative or accessible. All you can do is access one part of the system, leave your message, and log off. There are no doors or windows to pass through.

● If you were to try your hand at illegally moving funds from one account to another you would probably start off with the Bankers Automated Clearing Service (BACS). It works in much the same way as a cashpoint machine. You dial up a readily available number, and are then invited to enter a four digit code number, followed by your account number, then you key in the transaction.

If you get the number wrong the system shuts off and the bank is alerted. The only way to defraud this is to steal someone's number and details, which can hardly be construed as hacking.

Even then, each account has its own limit and the bank's security system carefully monitors all transactions. Let's say you attempt to move £10,000 from Company A into an account in Europe. If Company A rarely deals with Europe, or if it never deals in figures exceeding £5,000 the bank will be alerted. You would need detailed inside information.

The same system works with cashpoint cards. If someone steals your card, secures your PIN number, and then starts drawing large sums from different parts of the country, the bank's comput-

ers will alert a human operator.

● A hacker in the know would have to attempt a break in of the more heavy duty systems. The Clearing House Automated Payments System (CHAPS) is set up to provide inter-bank transfers. And the Society for World Wide Inter-bank Financial Transactions (SWIFT) is its international version. Millions of dollars have passed through these systems every day since they were installed six years ago. There is not one documented case of them being defrauded by a hacker.

Both rely on the state-of-the-art in American encryption techniques. One false move will trigger off an auto-destruct program. Remember that hackers rely on trial and error to break through systems.

## Internal fraud

The banking community firmly believes its computer security is only threatened by insiders who have all the relevant data and could transfer enormous funds from one account to another, before leaving the country. CIB spokesman, Alexander Moffatt, commented: "The electronic transfer of funds makes internal fraud easier than in days gone by." He said that the CIB, which also acts as an education and examination board for its members, had seen a sharp increase in the number of bank managers taking Information Technology courses in order to fully understand their computer systems. The

CIB was formed in 1879 and boasts 136,000 members.

Former hacker Steve Gold, who was arrested in 1985 for breaking into Prince Philips' Prestel mailbox, told *Express*: "Given the level of security in the British banking system I would be very surprised if anyone had managed to get in. I'm also surprised with the blackmail story. If anyone was clever enough to get in there, the smart thing to do would be get hold of £10 million and get out."

"There are some good hackers around, but I don't think any of them are that good." He said that any security breaches will have been either inside jobs or at an absurdly low level. "I think this whole thing is a storm in a teacup. But given the media interest I wouldn't like to be in the shoes of anyone who had broken in. The banks are very formidable. Now it'll be a case of no holds barred."

## Prohibitive nature

One London based security consultant, who preferred to remain anonymous, said that many people in the hacking community liked to pretend they had broken into systems which they had not. Indeed, one "hacker" called us the day after *The Sunday Independent* article appeared claiming that he had broken into a bank's system. We asked him to provide technical facts, but he could not.

Hugo Cornwall, author of top selling guide *The Hackers Handbook* commented: "The prohibitive nature of the banking computer networks make it very unlikely that anyone has actually got in there." In his book, published before the Computer Misuse Act came into force, he advised hackers not to attempt breaking into the banking system, mainly because it is almost impossible to crack.

It is understood that the media was alerted following a banking and security conference held in London last month. An off-the-record meeting took place there, where the story of the five hackers was brought up. Details of that meeting were inevitably leaked.

As with most hacker scare stories precise details are desperately thin on the ground, and given the tremendous obstacles facing a would-be hacker it would appear that any attempted fraud would have to be an inside job.

However, *Express* regularly receives anonymous phone calls from individuals claiming to have either hacked a bank, or to have knowledge of bank hacks. Regrettably, we have yet to receive sufficient information on any case to warrant a deeper investigation.

## Serious labels

Gallic software company Loriciel is to launch an up-market label for its more "serious" products.

The new label, Futura, will publish what the Loriciel terms as its "quality product", such as the recent simulation-style games *Sherman M4* and *Tennis Cup*.

The Paris based company feels that such games deserve to be marketed separately from the arcade/action-style games since "They are very different genres".

Meanwhile, the good old shoot-em-ups and action games will continue to be published on the Loriciel label.

The first titles due to appear on Futura are *DISK* next month and *Advanced Destroyer Simulator* and *Panza Kick Boxing* in January. All will be published in the UK via US Gold. ■

## WP aids dyslexic

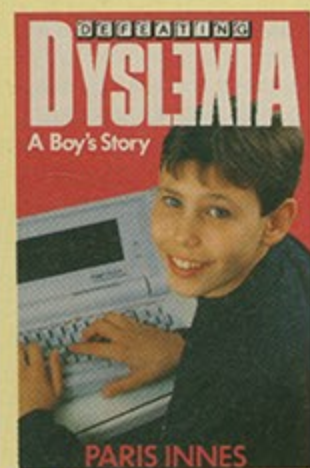

• *Defeating Dyslexia: how Paris helped defeat 'word blindness'.*

A dyslexic 14-year-old boy who could hardly write two years ago has managed to publish a book of short stories, thanks to the word processor.

Compiled originally as a Christmas present for family and friends *Defeating Dyslexia: A Boy's Own Story* is a testament to the progress Paris Innes has achieved using his Amstrad PCW and a Smith Corona PWP 7000 portable.

The London lad was diagnosed as dyslexic at the age of nine, and by the time he was 12 he was having real difficulty writing. But when his parents bought him a second-hand Amstrad for Christmas two years ago, the transformation was immediate.

"In six weeks the word processor made more difference to Paris' progress than two years of special lessons," says his father Trevor. ■



## Citizen hits the streets

The new 24-pin Citizen dot matrix printer is now in the High Streets, and its manufacturer reckons the machine should be top of every computer owner's shopping list.

It can manage 120 characters per second in draft mode and is compatible with almost every home computer available. At £279 (inc VAT) the 124D is claimed to be the cheapest printing option on the market. It also comes with a free two year warranty. Call Citizen on 0895 72621. ■

• Santa will now be able to print out his own cards

## Bouncing ball game bounces back!

Ocean plans to put the bounce back into your computer with the release of *Wizball II* early next year.

The follow up to the hugely successful *Wizball* is being developed by Sensible Software, the same team that worked on the 1988 original.

*Wizball* has proven to be one of Ocean's most enduring titles, and the company says the sequel has been brought about by public demand and pressure from the trade. ■

• *Wizball: Another ball next spring.*

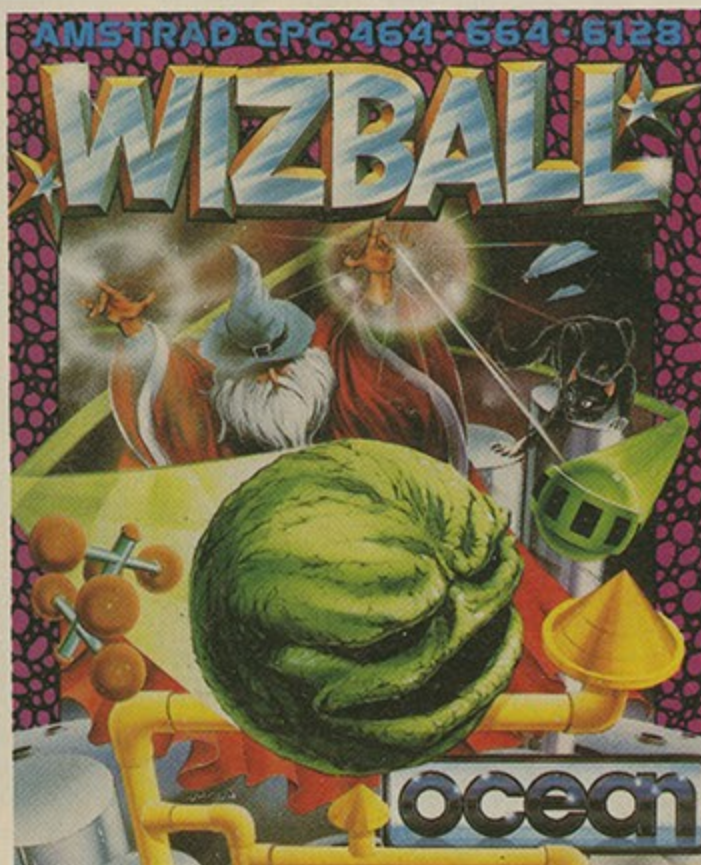

## Complete gaming system set for 1992

# PLAY WITH REAL VIDEO

We've heard a lot about grand new technologies currently under development, but it is pretty hard to appreciate the likes of CD-I or DVI if you're stuck at home with the trusty old 8-bit.

Nevertheless, even the most hardened future-naut must feel a twinge of excitement at news of a complete video gaming system being developed by Intel and Matsushita.

The Digital Video Interactive (DVI) system will allow you to play games using television

quality graphics. So instead of steering a graphical representation of a *Stealth Fighter* in your favourite flight sim, you'll be flying video footage over real landscapes. We kid you not!

This technology isn't so far away. Both Intel and Matsushita reckon on releasing a real video machine for business purposes next year. That would be used for interactive in-store point of sale material or as a business presentation tool. Perhaps a car manufacturer could let prospective clients test drive a new

motor from the comfort of an office. The two firms hope to have a home version ready as soon as 1992.

DVI allows the storage of motion video, audio, still pictures and text on CD format. It can display video at 30 frames per second – the same as television, so you can plug the system into your telly at home.

It is possible to interact with video at present, but due to the slow access speeds of today's media – laser disks – this is not a commercial reality. ■

## Back to business

Canadian firm Gold Disk has launched *Office*, a cheap business software bundle with some impressive features.

The sting for other bundles comes in *Office's* content: *Transcript*, a word processor with spelling check and mail merge, *Advantage*, a Lotus compatible spreadsheet with blinding speed and excellent graphics, *Office File*, a simple to use, flat-file database, and finally *Pagesetter 2*, a professional quality page layout system.

The whole package is completely integrated and costs a tempting £129.95.

Gold Disk's *Advantage* spreadsheet was to be launched as a single product, but despite favourable reviews, was withdrawn at the last minute. According to the company, this was because a major bug was found at a very late stage. That has now been ironed out.

It will be distributed here by HB Marketing. Call 0753 686000. ■

## Z88 to ST

Following its Z88 to Amiga link, Sector Software is to release an Z88-ST version. The kit is software and cable based and is likely to cost £25. A Sinclair QL version is also available. Interested linkers should contact 0772 454328. ■

## Megadrive mystery

Sega's much-vaunted 16-bit super games machine, the Megadrive, is viewed by many as the ultimate stocking filler this Christmas. Yet strange as it seems, at least one supplier cannot even give them away.

Major north east computer retailer Chips has been running a draw for a Megadrive for the last six weeks and although the draw has taken place not one winner has turned up to claim their prize.

A spokesman for Chips said: "We're amazed at the lack of response. Every customer who purchases something gets a ticket and is automatically entered in the draw. We've had a few calls to find out which number won, but not one winner."

So somewhere out there, six people are missing out on the fun. If you think you might have a winning ticket contact Chips on 0642 219139. Meanwhile, it's not too late to take part as the promotion continues until Christmas. ■



First Gameboy – now Game Gear and Game Mate

# NEW SEGA GAME GEAR HITS UK

The Sega Game Gear handheld console will be available as a grey import in the UK within two weeks.

UK importers, such as Cybertech in Gloucester, expect to be selling the console for around £180 here. Initially, three games will be available, but with the Japanese market already well supplied with Game Gear software, many more are expected by Christmas.

Top Game Gear titles in Japan include *Super Monaco GP* which includes 16 racetracks, a colour Tetris clone called *Columns and Pongo*, a weird maze/ *Pacman* affair. The sideways scrolling *Super Marios* also appear in *Wonderboy*. There's a baseball, air battle and mystic adventure game too.

The Game Gear itself is slightly larger than a Nintendo Gameboy and weighs less than 600g. It has a Z80A CPU running at 3.57MHz, 64K RAM, 128K video RAM and a custom LSI chip. It



also offers a full colour screen like that of the Atari Lynx.

An optional lead will be made available for multi-player gaming. Also, a neat tuner unit will be offered which transforms the console into a mini television.

Virgin Games, which will eventually be distributing the Sega

Game Gear officially in the UK, is, of course, none too happy with the situation. The firm is expected to officially launch the Game Gear in the spring.

Meanwhile, joystick manufacturer Cheetah is remaining quiet about its forthcoming mono handheld games machine the

Game Mate. As reported in *Express* last week the machine, from Taiwan, will be retailing for £59 – £10 less than the Nintendo Gameboy which apparently features a smaller screen.

Confident predictions are being made that the Game Mate will be arriving in November. ■

## New heavy duty generation

Remember MicroProse's heavy duty chopper sim *Gunship*? It was first launched four years ago and has become one of the most popular military games ever.

Now the American company is to release *Gunship II*, based on research into the Pentagon's future plans for its next generation of choppers.

*Gunship 2000* has been under secret development for the past 18 months and should be ready by this time next year. ■



• *Gunship 2000*: up, up and away

## Something small from Texas



• *Travelmate*: small ones are more juicy.

*Travelmate 2000* Notebook PC, the new laptop from Texas Instruments, has arrived, weighing in at less than 4.5 pounds.

Aimed squarely at the professional user, the *TravelMate* measures just 8.5 x 11 inches, but Texas guarantees that there has been "no sacrifice in functionality." It boasts a 20 megabyte hard disk and a VGA screen.

Fully AT-compatible, *TravelMate* has an 80C286 processor running at user-selectable speeds of 6, 7.16 or 12 MHz. It costs £2,650.

Texas promises more *TravelMate* related products soon. ■

## NIBBLES

• Despite IBM's third quarter profits increasing by 27 per cent to \$1.1 billion, traders on the UK and US stock markets are still sceptical about the company's prospects for 1991.

Problems over the past year, such as bloated overheads, competition from Japanese rivals, sluggish third-quarter sales of hardware and labour force reductions of 10,000, have combined to undermine confidence in the Big Blue.

• Following on from the recent launch of its 286 laptop, Commodore plans to release the 386sx version next spring. The price has yet to be announced.

• You might have thought that all the angles on computer soccer games had been used. But *Prosoccer 2190* from Vulture manages to add a few new intriguing twists to a sometimes tired genre. It's all set in the future, the ball never leaves the pitch, and it travels at a hell of a speed. Available for the ST and Amiga, the game retails at £19.99.

• ComputerL, Toshiba and six other software suppliers have joined forces for a business roadshow. The nationwide tour will stop at 13 cities and towns during November and December. Call 0753 512123 for details.

• Following the launch of the Classic, LC and the IIsi, Apple has reduced the price on its SE 30, IIsi and Portable machines by as much as £800 in some configurations. Interestingly, the IIsx has disappeared from the price-list altogether!

• Trilogic is now offering a complete sampling package for the Amiga for price of the software package alone. The recently-launched *Audiomaster III* software is now available with the Mark II stereo sampler thrown in free. Together they will set you back just £99.99.

• Good natured games publisher Code Masters thought the *Express* guide to the Christmas number one was a great idea - until we gave the company's top game *Dizzy 4* only a 46-1 chance of winning. But it has decided to stick a tenner on with us anyway. Best of all, if *Dizzy* does manage to win, the company will send £460 to Cancer Research. If it loses we'll spend the tenner in the pub. Any other charitable offers?

• Look out for *Between Planets*, a fanzine for ST owners. It's very off-the-wall, full of features and costs just 60p. If you can live without vacant prose and pretty pictures call 0506 56478.

# THE WEEK IN VIEW

Is the high street the best place to buy your computer? Robert Stallybrass, boss of Active Sales and Marketing, points you in the right direction of where to spend your hard-earned pennies.

When was the last time you went into a newsagent to buy a paper? When was the last time you went into a newsagent to buy a pair of shoes? Never.

It may be argued that you don't go into a high street electrical outlet to buy a computer, but instead go to your local computer dealer.

It's all about expertise. A car dealer knows all about cars - but sometimes if you want a car he will baffle you with RPM, BHP and MPG.

The same is true of some computer dealers Sprites, hardware, scrolling, ROMS, RAMS, Fat Agnes, Big Auntie . . . who knows.

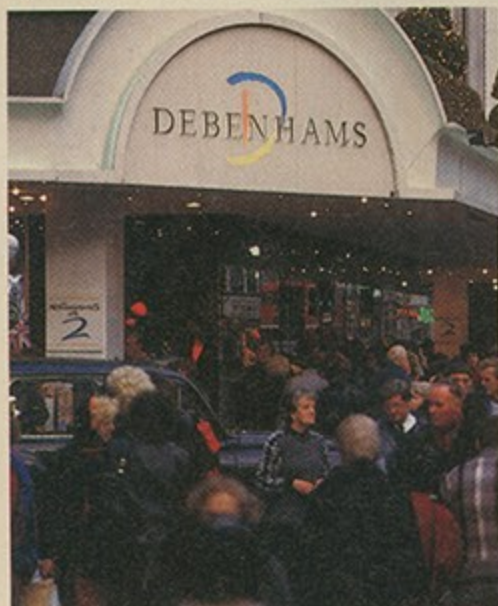

• Is there enough expertise in the high street?

about the product and will give you plenty of assistance. However, it may be that the manager of an electrical chain is an avid computer man and you will get as good, if not better support and assistance.

Some people take pride in their job. They want to know all about the latest technology, but they can talk to us mere mortals in a language we can understand, not in some sort of alien speak.

We have all heard stories of the public being given wrong information, and then acting on it . . . Did you know that all Commodore games

are compatible - well all those on tape! That's what a young sales assistant from a particularly large chain of shops told a mother last week who wanted to buy a computer for her son's birthday.

The moral of this story is "buyer beware". Always make sure that you know something about what you wish to buy, and talk to the specialist. Otherwise you may end up trying to run your C16 software on a Commodore 64.

## SO WHAT DO YOU DO?

Is it all about price? You know what you want and now you want the best price. But what if it goes wrong, can you send it back? This is especially difficult as Mail Order prices are often the best but will the company remain in business?

Generally, the independent retailer knows most

Hey! Get in touch with us! *Express* is always on the look out for news leads and tip-offs - and we'll pay you for passing them on too!

Also, if you have any burning ideas for features or surveys then drop us a line - remember, we cover every aspect of computing.

## Express Access

You can contact us directly on :

Voice : 0225 442244

Fax : 0225 446019

(All news leads and tip offs will be treated in strictest confidence)

Or you can leave E-Mail for us on :

CIX @ astorer

GOLD @ 84:TXT152

COMPUSERVE @ 100012, 1075

PRESTEL @ P McDonald

COMPUTER  
EXPRESS

EDITOR • Andy Storer  
DEPUTY EDITOR • Stuart Anderton  
NEWS EDITOR • Collin Campbell  
ART EDITOR • Amanda Cook  
TECHNICAL EDITOR • Keith Pomfret  
STAFF WRITER • Tim Smith  
PRODUCTION EDITOR • Julie Tolley  
SUB-EDITOR • Steve Coulter  
NEWS ASSISTANT • Dave Golder  
CONTRIBUTORS:  
Steve Carey • Robin Alway • Jason Holborn • Rod Lawton • Hadyn Fitz-Williams • Mark Higham • Adam Waring  
Richard Frederick • Sean Masterson  
Ken Coumarin • Ian Wrigley • Steve Gold  
ASSISTANT PUBLISHER • Jane Richardson  
CIRCULATION DIRECTOR • Sue Hartley  
AD MANAGER • Helen Kirkhope  
AD EXECUTIVES:  
Phil Davenport • Tim Partridge • Cheryl Beesley • Jason Spice  
AD PRODUCTION • Tracy O'Donnell  
AD TYPESETTING • Terry Turner  
PUBLISHER • Graeme Kidd

ABC audited circulation  
January-June 1990:  
21,251 copies per week

We regret we cannot enter into any personal correspondence. Technical enquiries should be addressed to Tech Tips at the address below.

While every care is taken in the preparation of *New Computer Express*, Future Publishing cannot be held responsible for the consequences of any errors that may occur.

© Future Publishing Ltd • 30 Monmouth Street, Bath BA1 2BW • Tel: 0225 442244 • Fax: 0225 446019 • Subscriptions: The Old Barn, Somerton, Somerset (0458) 74011 • Printed by Redwood Press, Melksham, Wilts • Distributed in UK and Eire by MMC Ltd (0483 211222), rest of world by Comag (0895 444055)

# COMING NEXT THURSDAY

## A Mac for your Amiga

Just how well does Amax II emulate the Macintosh?

## PC Pictures

Is Thinx the ultimate picturebase you're ever likely to need?

## PLUS

- Hot news
- Front End
- Games Week
- The Console Zone
- Whole Wired World
- Centrefold
- Tech Tips
- Circuit City
- Express On-line
- Express Mail
- The PD Column
- Columns for: Amiga, Arc, CPC, C64, Macintosh, PC, Spectrum, ST

## AND

News of a great new series on Programming

## AND

£££££££s of prizes

## OUT ON

NOVEMBER 1st

**NEW**

# Commodore SCREEN GEMS

# AMIGA 500



**SCREEN GEMS is  
the only NEW  
Official Amiga A500 pack  
from Commodore!**

### pack includes

- ☑ Amiga A500 Computer Keyboard
  - ☑ 512K Random Access Memory
  - ☑ Built-in 1 meg double-sided disk drive
  - ☑ Superb 4096 Colour Graphics
  - ☑ 4 Channel Digital Stereo Sound
  - ☑ Speech Synthesis
  - ☑ Multi-Tasking Operating System
  - ☑ Kickstart 1.3 and Workbench 1.3
  - ☑ Three Owners Manuals
  - ☑ Extras 1.3 and Tutorial Disk
  - ☑ Amiga BASIC Programming Language
  - ☑ Notepad Mini Word Processor
  - ☑ Commodore Mouse
  - ☑ Power Supply Unit with mains plug
  - ☑ TV Modulator
- ..and all connecting cables to get you up and running on your home TV set!

### plus

- ✓ Shadow of the Beast II
- ✓ Days of Thunder
- ✓ Back to the Future II
- ✓ Night Breed
- ✓ Deluxe Paint II Art Package

### plus FREE DIGISTAR pack

10 great software titles and accessories worth over £235 - Only from DIGICOM!

- |                          |                      |
|--------------------------|----------------------|
| ★ Microprose Soccer      | ★ Grand Monster Slam |
| ★ RVF Honda              | ★ Powerplay          |
| ★ Kid Gloves             | ★ Tower of Babel     |
| ★ Datastorm              | ★ Shufflepuck Cafe   |
| ★ Dungeon Quest          | ★ E-Motion           |
| ★ Microswitched Joystick | ★ Mouse Mat          |

**and exclusive to DIGICOM!!!**

### F-19 Stealth Fighter

The Ultimate Flight Simulator game from Microprose worth £34.99!

**Total package price includes VAT and Next Day Delivery by Courier\*  
Don't delay - Order now! 24Hour Credit Card Hotline Telephone (0908) 378008**

### How to Order

By Phone - Call our Credit Card Order line on (0908) 378008 and quote your card number and expiry date along with the details of the goods you require. We accept ACCESS, VISA, EUROCARD, MASTERCARD, AMEX the new Direct Debit cards like Barclays Connect and we also accept Lombard CreditCharge Cards.

By Mail - Simply write down your requirements and send in your order to us by post along with a personal cheque, bankers draft, building society cheque or postal order made payable to "DIGICOM COMPUTER SERVICES LTD". \*Please note:- Personal cheques require 7 days clearance before despatch.

Next Day Delivery is Mon-Fri, Saturday Delivery is £3.00 extra

### Catalogues!

Ring or write in for our latest Amiga catalogue listing hundreds of products available for this versatile Home Computer. We stock COLOUR PRINTERS, STEREO COLOUR MONITORS, EXTERNAL DISK DRIVES, MEMORY EXPANSIONS, HARD DISK DRIVES, AMIGA BOOKS, FRAME GRABBERS, DIGITISERS, SCANNERS, WORD PROCESSORS, DATABASES, SPREADSHEETS, ACCESSORIES and of course hundreds & hundreds of games and all at well below recommended retail prices!

### Service you can depend on!

Digicom offer you the very best in customer after sales support with 12 month warranty on all Computer Hardware. All units are full UK specification with 30 day replacement guarantee on faulty items and FREE collection of the defective units within this period. And should you ever need any technical advice our experienced and helpful staff are available on the telephone or in our showroom. Remember - there are no hidden extras - all prices are fully inclusive of VAT and next day courier delivery. Prices & Specifications are subject to change without notice E&OE.

only.....

# £399

\* or spread the cost with our finance facilities - written details on request.

# DIGICOM

36-37 Wharfside Watling Street  
Fenny Stratford Milton Keynes MK2 2AZ  
Telephone (0908) 378008 - Fax (0908) 379700  
Showroom Hours - Mon to Sat  
9.00am-5.30pm

# Special Reserve NRG CYBERZINE

## SPECIAL RESERVE CLUB BENEFITS INCLUDE:

- **NRG** (Energy magazine) News, Reviews and Graphics. Screen shots, pack shots, charts, latest Giga-Savers. 40 colour reviews in every issue. Night City Cybertoon and the kill-or-die adventures of the Cyberpunk **NRG** street gang - It's Cyber-fantastic!
- **NRG** - bi-monthly to all Special Reserve members.
- **Release Schedules**, sent bi-monthly with updated catalogue information.
- **Sales hotline**, to 8pm weekdays, 5-30pm Saturdays and 5pm Sundays. 0279 600204
- **Fast despatch** of stock items *individually wrapped by first class post.*
- **Written confirmations** (receipts) sent when we receive each order.
- **Catalogue, Membership Card & Folder** for **NRG**.
- **Refunds** or change of order on request if delayed.
- **No Obligation** to buy. We do not require a signed contract, nor is there any age requirement. With Special Reserve there are no hidden costs.

**ANNUAL UK MEMBERSHIP £6.00**  
EEC £8.00 WORLD £10.00

## Commodore Amiga

In stock at time of publication.



**Amiga 500 Screen Gems Pack 359.99**  
COMPUTER WITH MOUSE, TV MODULATOR, BACK TO THE FUTURE 2, DAYS OF THUNDER, BEAST 2, DELUXE PAINT 2 & NIGHTBREED.

### Amiga Peripherals

PHILIPS 8833 COLOUR STEREO MONITOR	249.99
PHILIPS TELEVISION TUNER FOR 8833 MONITOR	49.99
(CONVERTS THE MONITOR INTO A TELEVISION)	
AMIGA A590 20 MEG HARD DRIVE	354.99
CUMANA EXTERNAL 3.5" 880K DISK DRIVE	79.99
AMIGA A501 RAM UPGRADE TO 1 MEG (GENUINE COMMODORE ITEM WITH CLOCK)	99.99
ZYDEC RAM UPGRADE TO 1 MEG WITH CLOCK	49.99
ZYDEC RAM UPGRADE TO 1 MEG	44.99
MONITOR STAND, WIRE FRAME, ACCESS TO DRIVE	19.99
NAKSHA MOUSE, BRACKET AND MAT (AMIGA OR ST)	32.99
MIDI MASTER AMIGA MIDI INTERFACE	32.99
COVER FOR AMIGA	5.49
COVER FOR MONITOR	5.99
KIND WORDS 2 (WORD PROCESSOR)	31.99

### Disks 'n bits

**65p** **SONY**  
**3.5" DS/DD**  
**DISK + LABEL**  
GG413  
**65p each**

PLASTIC STORAGE BOX, HOLDS TEN 3.5" DISKS	1.30
3.5" SONY HIGH DENSITY DISK (1.4 MB)	1.39
10 PACK TDK 48 TPI 5.25" DS/DD DISKS (360K)	6.49
10 PACK TDK HD 5.25" DISKS (1.4 MB)	9.99
10 PACK TDK 96 TPI 5.25" DS/DD DISKS (720K)	8.99
3" MAXELL CF2 DISK + LABEL FOR PCW	1.99
3.5" DISK HEAD CLEANER	2.99
DISK BOX 3.5" (100 CAP) DIVIDERS, LOCKABLE	10.99
DISK BOX 3.5" (40 CAP) DIVIDERS, LOCKABLE	7.49
DISK BOX 3.5" (80 CAP) DIVIDERS, LOCKABLE	8.49
DISK BOX, STACKABLE, 3.5" (90 CAP) DRAWER	13.99

## BIGGEST CLUBS GREATEST DEALS

Over 2,000 products in our catalogue

# SHOCKING

Over 30,000 members



6.99

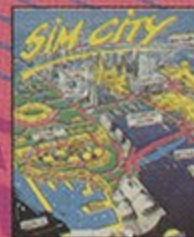

11.99



10.99



8.49



5.99



9.99

## AMIGA and ATARI ST Shockware

16 BIT	AMIGA	ST	16 BIT	AMIGA	ST	16 BIT	AMIGA	ST
3D POOL	8.49	8.49	FUTURE WARS	16.49	16.49	POWERDRIFT	5.99	5.99
688 ATTACK SUB	16.99		GAUNTLET 2	8.99	8.99	POWERDROME	8.99	8.99
ACCOLADE IN ACTION (BLUE ANGELS)			GFA BASIC V3.0 COMPILER	22.49	22.49	POWERMONGER	18.99	18.99
4TH N' INCHES, GRAND PRIX			GFA BASIC V3.0 INTERPRETER	36.99	36.99	PROJECTYLE	16.49	16.49
CIRCUIT, FAST BREAK	19.49	19.49	GHOULS 'N' GHOSTS	10.99	10.99	PROPHECY - VIKING CHILD	16.49	16.49
ADIDAS CHAMPIONSHIP FOOTBALL	16.49	16.49	GO PLAYER PROFESSIONAL	19.99	19.99	PROTEXT WORD PROCESSOR	64.99	47.99
ALPHA WAVES	15.99	15.99	GOLD OF THE AZTECS	16.49	13.99	PUBLISHERS CHOICE DTP (1 MEG)	59.99	
ALTERED BEAST	7.99		GOLD RUSH! (SIERRA)	16.49	6.99	PURPLE SATURN DAY	5.99	5.99
AMOS (GAMES CREATOR)	29.99		GOLDEN AXE	16.49	16.49	PUZZNIC	16.99	13.99
AMOS SPRITES 1000	10.99		GRAND PRIX CIRCUIT	6.99		QUEST FOR GLORY (1 MEG)	22.99	22.99
APPRENTICE	12.99	12.99	GRAVITY	6.99	8.99	QUESTRON 2 (SSI)	17.49	
ARCHIPELAGOS	6.99	6.99	GREG NORMAN'S GOLF	17.99	17.99	R-TYPE	4.99	4.99
ARMOUR-GEDDON	16.49	16.49	GUILD OF THIEVES (M-SCROLLS)	6.99	8.99	RAINBOW ISLAND	16.49	13.49
ATOMIC ROBOIDS	16.49	16.49	HARD DRIVIN'	15.99	15.99	RAMROD	17.49	17.49
AUSTERLITZ (BATTLE OF)	11.99		HARD DRIVIN' 2	15.99	15.99	REACH FOR THE SKIES (PSS)	19.49	19.49
AWESOME	21.99		HARPOON	19.49		RED LIGHTNING (SSI)	19.49	19.49
BAAL	6.49	6.49	HILL STREET BLUES	16.49	16.49	RED STORM RISING	16.99	16.99
BACK TO THE FUTURE 2	16.49	16.49	HIT DISKS VOLUME 2 (MAJOR MOTION, LEATHERNECKS, TIME BANDIT, TANGLEWOOD)	7.99		RICK DANGEROUS 2	16.49	16.49
BAD LANDS	16.49	16.49	HITCH HIKERS GUIDE (BUDGET)	8.99	8.99	RIDERS OF ROHAN	19.49	16.49
BALANCE OF POWER	6.99	6.99	HOLLYWOOD COLLECTION (ROBOCOP, GHOSTBUSTERS 2, INDIANA JONES, BATMAN THE MOVIE)	18.99	18.99	ROBOCOP 2	15.99	15.99
BALLISTIX	4.99	6.49	HOLLYWOOD HUINX (INFOCOM)	17.49	7.49	ROCKET RANGER	9.99	5.99
BALLYHOOD (INFOCOM)	7.99	5.99	HOME ACCOUNTS (DIGITA)	22.99	22.99	ROGUE TROOPER	16.99	16.99
BARBARIAN 2 (PALACE)	7.99		HOME OFFICE KIT (KIND WORDS 2.0, MAXI PLAN, INFO FILE, PAGESSETTER, ARTISTS' CHOICE, CALEFONTS)	86.99		RORKE'S DRIFT	15.99	15.99
BARDS TALE 2	8.99		HORROR ZOMBIES	16.49	16.49	S.T.U.N RUNNER	16.49	16.49
BATMAN THE MOVIE	11.99		HOUND OF SHADOW	8.99	8.99	SCRABBLE DE LUXE	13.49	13.49
BATTLE COMMAND	16.49	16.49	HUNT FOR RED OCTOBER	8.99	8.99	SEASTALKER (INFOCOM)	11.99	5.99
BATTLE OF BRITAIN	19.49		HYBRIS	5.49		SECOND FRONT	19.49	
BATTLE OF BRITAIN (D'S DRIVE)	19.49	19.49	IMMORTAL (1 MEG)	16.49	16.49	SECRET AGENT SLY SPY	16.49	13.49
BATTLE SQUADRON	8.49		IMPERIUM	16.99	16.99	SECRET OF MONKEY ISLAND	16.99	16.99
BATTLECHESS	16.49	16.49	INDIANAPOLIS 500	16.49		SHADOW OF THE BEAST	9.99	16.49
BATTLEMASTER	17.99	15.49	INFESTATION	15.99	14.49	SHADOW WARRIORS	16.49	13.49
BATTLESTORM	16.49	16.49	INFIDEL (INFOCOM)	7.99	13.99	SHADOWGATE	16.49	
BEAST 2	21.99		INTERNATIONAL 3D TENNIS	16.99	16.99	SHOCKWAVE	16.49	
BETRAYAL	19.49	19.49	INTERNATIONAL SOCCER CHALLENGE	16.49	16.49	SHOGUN (INFOCOM)	18.99	
BEYOND ZORK (INFOCOM)	24.99	7.99	ISHIDO	19.99		SHOOT 'EM-UP CONSTR KIT	7.99	8.49
BILLY THE KID	16.99	16.99	IT CAME FROM THE DESERT	10.99	10.99	SILENT SERVICE (SUB SIM)	8.49	8.49
BLACK CAULDRON	6.99	6.99	IT CAME FROM THE DESERT (1 MEG)	10.99	10.99	SIM CITY	11.99	11.99
BLACK LAMP	6.49		LC.F.T. DESERT DATA DISK (1 MEG)	10.99	10.99	SIM CITY TERRAIN EDITOR	10.49	
BLTKRICKS - MAY 1940	15.99	15.99	IVAN STEWARTS OFF-ROAD RACER	16.49	16.49	SKYACTRA	16.49	16.49
BLOOD MONEY	7.49	7.49	J. NICKLAUS GOLF	16.99	16.99	SKYCHASE	5.99	5.99
BLOODWYCH	6.99		J. NICKLAUS VOL1 COURSES	9.99		SKYFOX	4.99	
BLOODWYCH - DATA DISK	10.49	8.99	J. NICKLAUS VOL2 INT COURSES	9.99		SNOWSTRIKE	16.49	16.49
BLOODWYCH DATA DISK	10.49	15.99	JAMES POND	16.49	16.49	SORCERER (INFOCOM)	5.99	5.99
BREACH 2	15.99		JEWELS OF DARKNESS (LEVEL 9)	6.99	6.99	SPACE ACE	27.99	27.99
BREACH 2 (1 MEG)	15.99		JINXTER (M-SCROLLS)	6.99	6.99	SPACE HARRIER 2	6.99	
BRIDGE PLAYER 2150 GALACTICA	19.99	19.99	JUDGE DREDD	13.99	13.99	SPACE QUEST 3 (SIERRA)	22.99	19.99
BUCK ROGERS (SSI)	19.99		K-SPREAD 2.0 (SPREADSHEET)	42.99		SPACE ROGUE	17.99	17.99
BUDOKAN	16.99		K-SPREAD 4.0 (SPREADSHEET)	85.99		SPEEDBALL 2	15.99	15.99
CADAVER	16.49	16.49	KICK OFF	6.99	6.99	SPELLBOUND	13.49	13.49
CAPTIVE	15.49	15.49	KICK OFF 2	12.99	12.99	SPELLBREAKER (INFOCOM)	13.99	5.99
CARRIER COMMAND	10.49	8.99	KICK OFF EXPANSION DISK	7.99	7.99	SPY WHO LOVED ME	16.49	16.49
CARTHAGE	16.49	16.49	KID GLOVES	7.99	16.99	ST ADVENTURE CREATOR	15.99	
CHAMPION OF THE RAJ	16.49	16.49	KILLING GAME SHOW	16.99		STAR RAY	13.99	5.99
CHAMPIONS OF KRYNN (1 MEG)	19.99		KIND WORDS 2.0 (W/PROCESSOR)	31.99		STARGLIDER	16.99	16.99
CHAMPIONS OF KRYNN (SSI)	19.99	19.99	KINGS QUEST 1, 2 & 3 (SIERRA)	22.99	22.99	STARGLIDER 2	6.49	
CHAOS STRIKES BACK	10.99	10.99	KINGS QUEST 4 (1 MEG) (SIERRA)	21.99	21.99	STATIONFALL (INFOCOM)	5.99	5.99
CHAOS STRIKES BACK (1 MEG)	15.99		KLAX	13.49	13.49	STORM ACROSS EUROPE (SSI)	19.49	19.49
CHAOS STRIKES BACK EDITOR	10.99		KNIGHT ORC (LEVEL 9)	4.99	4.99	STOS (GAMES CREATOR)	19.99	19.99
CHASE H.O.	16.49	13.49	KRISTAL	10.49	15.49	STOS COMPILER	16.49	13.99
CHASE H.O. 2	16.49	16.49	LANCELOT (LEVEL 9)	6.99	5.99	STREET HOCKEY	16.49	16.99
CHESS CHAMPION 2175	19.99	19.99	LEATHER GODDESSES (BUDGET)	5.99	5.99	STRIDER 2	16.49	16.49
CHESSMASTER 2000	8.99		LEATHER GODDESSES (INFOCOM)	8.99	8.99	SUBBITO	15.99	15.99
CHESSMASTER 2100	18.49		LEGEND OF FAERGHIL	17.99	17.99	SUPER GRIDRUNNER	8.49	7.99
CHRONOQUEST 2	8.49		LEGEND OF THE SWORD	4.99	4.99	SUPER HANG ON	8.99	9.99
CHUCK YEAGER'S APT 2.0	16.99	16.99	LEISURE SUIT LARRY 1 (SIERRA)	19.49	19.49	SUPER WONDERBOY	7.99	7.99
CID & KINGDOMS	6.99	8.99	LEISURE SUIT LARRY 2 (SIERRA)	15.99	11.99	SUPERBASE PERSONAL 2 (DATABASE)	69.99	69.99
CODENAME: CEMAN (1 MEG) (SIERRA)	24.99	24.99	LEISURE SUIT LARRY 3 (SIERRA)	24.99	24.99	SUPERPLAN (1 MEG SPREADSHEET)	69.99	69.99
CODENAME: CEMAN (1 MEG) (SIERRA)	24.99	24.99	LIGHT CORRIDOR	15.99	15.99	SUPREMACY	19.49	19.49
CODENAME: CEMAN (1 MEG) (SIERRA)	24.99	24.99	LOMBARD RAC RALLY	8.99	8.99	SWORD OF SODAN	9.99	
COLORADO	16.49	16.49	LOOM	19.49	19.49	SWORDS OF TWILIGHT	8.99	
CONFLICT EUROPE	16.49	5.99	LORDS OF THE RISING SUN	9.99		T.N.T. (APB, HARD DRIVIN', TOOBIN, DRAGON SPIRIT, XYBOTS)	19.49	19.49
CONQUEROR	15.49	15.49	LOTUS ESPRIT TURBO CHALLENGE	17.49	17.49	TEAM YANKEE	19.49	19.49
CONQUESTS OF CAMELOT (1 MEG)	24.99	24.99	LURKING HORROR (INFOCOM)	5.99		TEENAGE MUTANT HERO TURTLES	15.99	15.99
CORPORATION	14.99	14.99	M.U.D.S. (MEAN UGLY DIRTY SPORT)	15.49	15.49	THE KEEP	16.99	16.99
CORRUPTION (M-SCROLLS)	6.99	6.99	M.1 TANK PLATOON	19.49	19.49	THE LOST PATROL	16.49	16.49
CRACK DOWN	7.49	7.49	MAGIC FLY	16.49	16.49	THEME PARK MYSTERY	7.99	7.99
CRIMEWAVE	16.49	16.49	MANHUNTER SAN FRANCISCO (SIERRA)	9.99	9.99	THREE STOOGES (CINEMAWARE)	6.99	
CURSE OF THE AZURE BOND (SSI)	19.99	19.99	MEAN STREETS	16.49	16.49	THUNDERBIRDS	4.99	6.99
CUTTHROATS (INFOCOM)	9.99	17.49	MENACE	5.49	6.99	THUNDERSTRIKE	16.99	16.99
DAMOCLES	15.49	15.49	MICKEY MOUSE	5.99	5.99	TIME MACHINE	16.99	16.99
DAYS OF THUNDER	15.99	15.99	MIDNIGHT RESISTANCE	16.49	16.49	TIMES OF LORE	6.99	
DEATH TRAP	15.49	15.49	MIDWINTER	19.99	19.99	TIMEWORKS DESK TOP PUBLISHER	75.49	
DEJA VU	6.99	3.99	MIGHT AND MAGIC 2	19.99		TOKI	16.49	16.49
DELUXE MUSIC CONSTR SET	45.99		MILLENIUM 2.2	6.99	6.99	TORVAK THE WARRIOR	16.49	16.49
DELUXE PAINT	34.99		MONTY PYTHON'S FLYING CIRCUS	13.99	13.99	TOTAL RECALL	15.99	15.99
DELUXE PAINT 3	49.99		MURDER	16.49	13.99	TREASURE TRAP	15.99	15.99
DELUXE VIDEO 3	62.99		MURDER IN SPACE	15.99	15.99	TRIAD VOL2 (MENACE, BAAL, TETRIS)	7.99	
DICK TRACY	15.99	15.99	MYSTICAL	15.99	15.99	TRIAL PURSUIT	4.99	8.99
DISNEY ANIMATION STUDIO	59.99	59.99	N.A.R.C.	16.49	16.49	TURBO CUP	4.99	5.49
DRAGON BREED	16.49	16.49	NEBULUS 2	16.49	16.49	TURBO CUP (WITH CAR)	10.99	10.99
DRAGON WARS	16.49		NECROMOM	17.49	15.99	TURBO SILVER GRAPHIC/ANIMATION	106.49	106.49
DRAGON'S LAIR	28.99	28.99	NEUROMANCER	16.99		TURRICAN	12.99	12.99
DRAGON'S LAIR (1 MEG)	28.99	27.99	NEVER MIND	6.49	6.49	TV SPORTS (U.S.) FOOTBALL	11.99	9.99
DRAGON'S LAIR 2	27.99	27.99	NEW ZEALAND STORY	13.99	13.99	TV SPORTS BASKETBALL	11.99	16.49
DRAGONFLIGHT	18.49	18.49	NIGEL MANSELL'S GRAND PRIX	6.99	6.99	ULTIMA 5	18.49	18.49
DRAGONSLIGHT	8.99	8.99	NIGHTBREED (ACTION)	16.49	16.49	ULTIMATE RIDE	15.99	15.99
DRAGONSTRIKE (SSI)	19.99		NIGHTBREED (INTER-ACTIVE MOVIE)	16.99	16.99	UMS - UNIVERSAL MILITARY SIM	7.99	
DRAKKHEN	11.99	11.99	NIGHTSHIFT	16.99	16.99	UMS 2 - UNIVERSAL MILITARY SIM 2	19.99	19.99
DUNGEON MASTER	10.99	10.99	NITRO	16.99	16.99	UN SQUADRON	16.49	16.49
DUNGEON MASTER (1 MEG)	10.99		NORTH AND SOUTH	10.99	10.99	UNINVITED	3.99	
DUNGEON MASTER EDITOR	8.99	8.99	NUCLEAR WAR	13.99	13.99	VAXINE	16.49	16.49
DYNASTY WARS	7.49	7.49	OPERATION HARRIER	16.49	16.49	VENUS - THE FLY TRAP	14.49	14.49
E-MOTION	6.99	6.99	OPERATION STEALTH	16.99	16.99	VETTE (CORVETTE)	18.99	
E-SWAT	16.49	16.49	OPERATION THUNDERBOLT	16.49	13.49	VIRUS	6	

# PRICES

# ADVENTURE MADNESS SALE

members in our clubs

Over 40,000 games in our warehouse



7.99 7.99 9.99 6.99 9.99 6.99

## Nintendo Gameboy

Official UK Version. Free Shockware holster worth £7.99.



Gameboy + Tetris, two player lead, stereo headphones and batteries plus **69.99**  
FREE Special Reserve membership or Shockware holster

Gameboy Software etc. (MORE SOON)

ALLEYWAY	15.99	SUPER MARIO LAND	15.99
GOLF	15.99	TENNIS	15.99
QIX	15.99	SHOCKWARE GAMEBOY	27.49
SOLAR STRIKER	15.99	HOLSTER WITH BELT	7.99

## Sega Megadrive

Official UK Version. Free extra Joypad and membership.



Megadrive + Altered Beast + Joypad + extra TURBO Joypad FREE **189.99**  
+ FREE Special Reserve membership

Megadrive Software

ALEX KIDD IN THE ENCHANTED CASTLE	23.99	REVENGE OF SHINOBI	27.49
ARNOLD PALMER GOLF	27.49	SPACE HARRIER 2	27.49
FORGOTTEN WORLDS	27.49	SUPER HANG ON	27.49
GHOULS N GHOSTS	34.49	SUPER LEAGUE BASEBALL	27.49
GOLDEN AXE	27.49	THUNDERBLADE	27.49
LAST BATTLE	27.49	THUNDERFORCE 2	27.49
MYSTIC DEFENDER	27.49	TRUXTON	27.49
RAMBO 3	23.99	WORLD CUP ITALIA 90	23.99
		ZOOM	23.99
POWER BASE CONVERTER (Runs Master System Games)	28.49		
TURBO (FAST FIRE) JOYPAD	17.49		
SEGA MEGADRIVE ARCADE POWER STICK	34.99		

INEVITABLY, SOME GAMES SHOWN MAY NOT YET BE RELEASED.  
Inter-Mediate Ltd. Reg. Office: 2 South Block, The Maltings, Sawbridgeworth, Herts CM21 9PG. VAT reg. no. 424 8532 51

## Atari Lynx

Official UK Version. In stock at time of publication.

Lynx colour handheld system + mains powerpack & California Games **159.99**

Lynx Software

3D BARRAGE	27.49	GAUNTLET 3	27.49
BLUE LIGHTNING	21.99	KLAX	27.49
CHIPS CHALLENGE	21.99	MS PACMAN	27.49
ELECTRO COP	21.99	PAPERBOY	27.49
GATES OF ZENDECON	21.99	RAMPAGE	27.49

## Sega Master System

Official UK Version. Free Special Reserve membership.



SEGA MASTER SYSTEM, TWO JOYPADS, HANG ON ..... **79.99**  
SEGA MASTER PLUS SYSTEM WITH LIGHT PHASER GUN, HANG ON & MARKSMAN GAMES ..... **99.99**  
FREE SPECIAL RESERVE MEMBERSHIP WHEN YOU BUY EITHER OF THE ABOVE SYSTEMS (EXISTING MEMBERS DEDUCT £6.00)  
QUICKJOY SG JETFIGHTER MASTER SYSTEM JOYSTICK... **13.99**

## Sega Master Software

ACTION FIGHTER	11.99	INDIANA JONES	22.99
AFTERBURNER	22.99	MONOPOLY	22.99
ALEX KIDD	19.99	NINJA	9.99
ALEX KIDD HIGH TECH WORLD	22.99	OPERATION WOLF	22.99
ALEX KIDD SHINOBI WORLD	22.99	OUTRUN	22.99
ALEX KIDD LOST STARS	22.99	PAPERBOY	22.99
AMERICAN BASEBALL	22.99	PARLOUR GAMES	14.99
AMERICAN PRO FOOTBALL	22.99	PRO WRESTLING	22.99
AZTEC ADVENTURE	11.99	R-TYPE	22.99
BOMBER RAID	22.99	RAMBO 3	22.99
CALIFORNIA GAMES	22.99	RASTAN	22.99
CASINO GAMES	22.99	RESCUE MISSION	9.99
CHASE HQ	22.99	ROCKY	22.99
CYBORG HUNTER	19.99	SECRET COMMAND	11.99
DOUBLE DRAGON	22.99	SHINOBI	22.99
DYNAMITE DUX	22.99	SUPER MONACO G.PRIX	22.99
ENDURO RACER	9.99	SUPER TENNIS	9.99
F16 FIGHTER	14.99	TEDDY BOY	22.99
GAUNTLET	22.99	TENNIS ACE	22.99
GHOSTBUSTERS	22.99	TRANSBOT	9.99
GOLDEN AXE	22.99	ULTIMA 4	29.99
GOLFAMANIA	25.49	WONDERBOY	19.99
GREAT BASKETBALL	19.99	WONDERBOY 3	22.99
GREAT GOLF	19.99	WORLD SOCCER	19.99
IMPOSSIBLE MISSION	22.99	ZILLION 2	23.99

## Joysticks, Mice etc.

UK Postage included, EEC add 10%, World add 25%.



**Back Row (left to right)**  
Quickshot 123 15 pin analogue for IBM PC ..... **12.99**  
Quickjoy M5 15 pin joystick for IBM PC ..... **18.49**  
Quickjoy Superboard (ST, AMIGA ETC) ..... **18.49**  
Quickjoy Jet Fighter (ST, AMIGA ETC) ..... **14.99**  
Quickjoy Supercharger (ST, AMIGA ETC) ..... **12.95**  
**Front Row**  
Competition Pro Extra autofire (ST, AMIGA ETC) ..... **12.49**  
Witty C400A1 IBM Serial Mouse plus software ..... **32.99**  
Naksha Mouse and Mat For Amiga or ST ..... **32.99**  
Konix Megablaster (ST, AMIGA ETC) ..... **5.99**

**Amiga/ST Joysticks etc. not shown.**  
COMPETITION PRO 5000 BLACK ..... **10.99**  
COMPETITION PRO 5000 MEAN GREEN ..... **10.99**  
COMPETITION PRO 5000 RED/WHITE ..... **9.99**  
COMPETITION PRO 5000 WHITE ..... **10.99**  
COMPETITION PRO EXTRA COMBAT ..... **12.99**  
COMPETITION PRO EXTRA GLO GREEN ..... **12.99**  
COMPETITION PRO EXTRA GLO RED ..... **12.99**  
EUROMAX PROFESSIONAL COMPETITION 9000 ..... **11.49**  
KONIX NAVIGATOR JOYSTICK AUTOFIRE ..... **12.99**  
KONIX SPEEDKING JOYSTICK AUTOFIRE ..... **11.99**  
QUICKJOY INFRA-RED JOYSTICK ..... **33.99**  
MOUSE MAT (QUALITY SOFT MAT) ..... **4.99**  
POPULOUS/FALCON LEAD (NULL MODEM CABLE) ..... **8.99**  
FOUR PLAYER AMIGA/ATARI ST JOYSTICK ADAPTOR (FOR KICK OFF 2, LEATHERNECKS, GAUNTLET 2 AND TV SPORTS BASKETBALL FITS PRINTER PORT) ..... **7.99**  
**IBM PC Joysticks etc. not shown.**  
CHAMP JS 606 IBM XT/AT ANALOG AUTO JOYSTICK ..... **15.49**  
COMPETITION PRO PC STYLE (IBM) ..... **12.99**  
DYNAMICS IBM GAMES CARD WITH TWIN JOYSTICK PORT INTERFACE (9 PIN) ..... **19.99**  
EUROMAX IBM ANALOGUE 3001 JOYSTICK ..... **12.99**  
KONIX AMSTRAD/IBM PC GAMES CARD WITH TWIN PORT INTERFACE ..... **7.99**  
KONIX SPEEDKING IBM JOYSTICK ..... **15.99**  
QUICKSHOT QS-120 DELUXE IBM GAMES CARD ..... **15.99**

OR JOIN EUROPE'S BIGGEST ADVENTURE CLUB

## OFFICIAL SECRETS

FOR ADVENTURES AND ROLE PLAYING AND MORE

All the benefits of Special Reserve plus:

### Confidential.

Our 32 page bi-monthly magazine is essential reading for those interested in adventures or role-playing games. Written by experts, Confidential has covered everything from How to Host a Murder to Which F16 Flight Simulator? Our agents, led by the Master Spy known as "The Boss Upstairs", seek out the secrets of RPG's, FRP's, MUG's, PBM's, Leisure Suit Larry, The Russians, Elvira..... and more.

### Sim City or Corporation.

Choose one free for Atari ST, Amiga or IBM. Please phone if you have a different machine.



Of Corporation, ACE said: "Probably the most influential game of this genre making this an essential addition to your collection. Zero said: If you liked Dungeon Master you'll love this. Of Sim City, ACE said: "Sim City is a politician's - or a gamer's - dream... comparisons spring immediately to mind with Populous... but Sim City seems to have much more depth....". C&VG said: "Sim City is utterly fab"

### Help-Line - to help you solve most games.

Manned weekdays until 8pm and on Sundays (not an 0898 number)

### Myth - exclusive to Official Secrets members.

Written by Magnetic Scrolls, authors of Wonderland, Myth is a mini adventure set in Ancient Greece. In it you'll meet The Ferryman, cheat Death and face the nine-headed Hydra. Myth includes the famous Magnetic Scrolls parser and graphics and is included in the price of membership.



Amiga Format said: "An excellent adventure... witty, cunning and just plain good fun! If you liked Fish! you'll probably like this, because they're very similar in style: you may even prefer Myth, it's that good!"

Myth Ratings: CU 90%, Amiga Format 87%, TGM 85%, Crash 91%

**Official Secrets Annual UK Membership**  
With 6 issues of Confidential, Myth, Corporation or Sim City, Help-Line + membership of Special Reserve. **29.99**  
EEC membership £34.99. WORLD Membership £39.99.

**SALES LINES 0279 600204**

WE ONLY SUPPLY MEMBERS BUT YOU CAN ORDER AS YOU JOIN  
THERE IS A SURCHARGE OF 50P PER GAME FOR TELEPHONED ORDERS  
(PLEASE PRINT IN BLOCK CAPITALS)

Name & Address

Post Code \_\_\_\_\_ Tel. \_\_\_\_\_

Computer \_\_\_\_\_ \*5.25"/"3.5"/

Payable to: \_\_\_\_\_ \*3.0"/"TAPE

**Special Reserve or Official Secrets**  
P.O. Box 847, Harlow, CM21 9PH

Existing members please enter your Membership No. \_\_\_\_\_

**Special Reserve £6 UK, £8 EEC, £10 World or Official Secrets £29.99 UK, £34.99 EEC, £39.99 World**

Corporation  or with Sim City  and Myth  NCE6

PLEASE ENTER MEMBERSHIP FEE £ \_\_\_\_\_

Item \_\_\_\_\_ £ \_\_\_\_\_

Item \_\_\_\_\_ £ \_\_\_\_\_

Item \_\_\_\_\_ £ \_\_\_\_\_

Item \_\_\_\_\_ £ \_\_\_\_\_

Software Prices include UK or EEC Postage. World software orders please add £1.00 per item. For non-software items such as joysticks or blank disks please add 10% EEC or 25% World for carriage. Overseas orders must be paid by credit card.

Credit card expiry date \_\_\_\_\_

\*CHEQUE/POSTAL ORDER/ACCESS/VISA

## ■ Sim City

A game I used to play on an Atari 8-bit called *SS Achilles* by Beyond software, I would like to see on the 16-bit machines, but can find no address of this software house to write to and plead with them to revamp it. This leads me to ask why is there no software house that offers a service where requests for a particular item, say like the case of the chap looking for a sail boat simulator or some other type of software, could put in a request?

I would like to see a type of CAD electronic building block emulator for us budding engineers to try out without using the soldering iron and wasting components, or a Ham radio simulator like Dr DX to save going on air or a deep sea diving simulator.... enough of these Zapp ems!

P. Wilkinson Alford Lincs

Yes, P, not a bad idea that - personally I would like a millionaire simulator that lets you spend money without it actually costing you anything. While this might not be a minority request, I'm sure a deep-sea diving sim would be. Tell you what, we'll send you a tenner with which to produce a presentation you can send to some of the software houses. AS

## ■ Sore Points

I feel obliged to write in response to your "State of the Art" piece in the Oct 6 Issue and the Atari ST section.

Presumably written by one of your Amigaphiles, it perpetuated the ST/STE compatibility myth with the comment that with each machine modification "Hardware Addresses and important system variables get moved around".

This is complete nonsense, of course. No hardware address has ever moved and no documented system variable has ever moved on any ST(E) model. 99% of STE incompatibilities were not caused by "pushing the metal to the limits" or other such nonsense, but by games programmers using the ROM as a random number generator. As Atari had warned for several years, the ROM moved in the memory map on the STE and some programs broke.

In comparison with the Amiga, when Kickstart went from 1.2 to 1.3, a huge number of programs broke, even though the hardware stayed exactly the same and the operating system had only trivial changes. As for Workbench 2's compatibility problems, the least said the better. Naturally none of this got a mention in the Amiga section of the same item.

Andy Pennell, Furzton, Milton Keynes

## ■ Magnificent Bust

In June I placed an order for an amazing game called *Elvira* having read that it has a magnificent parade of gruesome bodies on six disks. Imagine my disappointment when two months later I was told that the distribution company had gone bust.

Anyway, what I want to know is can *Elvira* still be got. Also I have just got a PD software Mac emulator for my ST and I wonder if anyone knows how to use it (the



instructions are in German).

Michael Bucknell, Muswell Hill, London

Don't know about the gruesome body angle but I'll never forget the bust. You can get your hands on *Elvira's* amazing er disks via Accolade on 071 585 3308. As for the ST Mac emulator, does anyone want to win a fiver by helping this guy out? AS

## ■ Poor Sod

I am replying to Mr. Tony Kelly's insulting and cheap letter which was in your great 101 issue. You can insult me as much as you want I don't mind that sort of insult. Just insult me whenever life is bringing you down or the program crashes and my financial problems will be over. Well it is really bad that even when you are trying to be generous, somebody finds something wrong with it. Mr Kelly should get the bore of the week award. Waiting for your insults, advice and issue 102.

Mr W Park, Dorchester Dorset

Well there you are - a free Express masochist service. Send us any insults you like and we'll pass them on to the obliging Mr. W. AS

## ■ Market Research

I have often been tempted by offers in the classified section of your illustrious magazine, but have been put off by the pig-in-a-poke nature of the advertising. Not so much the individuals advertising items they've grown out of, but the companies with special deals and limited offers.

I have, indeed, often thought that the reviews given to major releases of hardware and software could usefully be extended to cover such things.

It is, perhaps, understandable that the resources and personnel needed for such an endeavour are beyond most magazines, unless that is the readers themselves (the very people the ads are aimed at) are involved. A hundred purchasers = a hundred reviewers. Perhaps a scheme involving a printed form and selected adverts could be devised where people fill in such questions as;

- How long did you wait for delivery?"

# EXPRESS MAIL

This week Haydn Fitz-Williams is in Leningrad, so it's over to Boss-man Andy Storer...

Write and tell HFW what you think about anything under the Sun! Reach him at: **Express Mail, 30 Monmouth Street, Bath BA1 2BW.** Sorry, no personal replies, even with an SAE, as we're too busy writing the magazine.

- Is the item as advertised?"

- Any particular problems in setting up/installing?,"etc.

- Any particular problem that cropped up regularly could be referred to the supplier and a solution found / published to the benefit of all.

An average could be worked out of the forms returned and a star rating awarded. This way I, for one, would know that a particular company was able to supply a reasonable product and service and wasn't likely to decamp when the complaints flow faster than the cheques.

In the absence of such a scheme, why not encourage people who purchase items from companies in your classifieds to write a brief review?

Now I come to mention it.....

Mr M Fairclough, Kenton, Middlesex

While I've no doubt such a scheme would be beneficial to potential purchasers, I'm not so sure our advertisers would like it. The reason being that a couple of bad reports - say where there's been an unaccountable delay in the mail - could lead to them losing revenue through no fault of their own. Of course there will always be cowboys, but all we can say is that if we hear of a bad egg we won't run their ad. I'll have a talk with our Publisher about your proposal though and see what the final verdict is. Coincidentally, this week we're starting the first of a monthly series of second hand buyers guides to the prices of hardware for sale in our free ads section. You'll find it on page 59. So if you have any suggestions as to how we can improve it, please send them in.

AS

## ■ Stateside Spines

Hi, I read with interest that crummy letter from Neil Crubbock in Issue 99 (Express Mail). I for one get your magazine off my cousin regularly. When he comes to the States, he gives me all his old issues. I am only fed up of one thing in your magazine and that's all those morons who write to say "My Amiga's better than yours". I'd like to have it said that your letters are otherwise entertaining, but how many don't get printed because too much space is

devoted to these stupid creatures who brag about their Amigas, Ataris etc. So there you have it Neil Crubbock: My dead hedgehog is better than your brain! P.S. Bet this doesn't get printed because of too many Atari/Amiga morons letters.

Martin Mathius Pittsburgh, USA

## ■ Footie Ref 1

In amongst all the wittering Amiga/ST nonsense appears the occasional gem. Can I thank KEC (NCE101 Announcements) for saving what remains of my Hair? Messy Dos was driving me up the wall! MSH: mounted without complaint - was listed for an "Assign" - but any attempt to access it met the "Accrington-Stanley" response. I'll now fork out the extra 12 pence (and accept the way you've chopped up machine-specific "pages" between pages) without one more grumble!

K J West, Walmer, Deal, Kent

Glad to have been of assistance K.J, but I've no idea what you're talking about. Would anyone out there like to win a fiver by telling us what on Earth the "Accrington Stanley" response could be?

AS

## ■ A Jolly Roger writes...

I've been a computer owner for six years. I've owned an Atari STe since they first came out. Here are some of my views on various subjects

1. Why buy games/utilities when you can get them for free?
2. With "Midwinter"... How can one shop take £14.95 and the othertake £29.95. Pure greed?
3. Public Domain means "Free Software". How many Public Domain Libraries have sent the author of the program they are selling there shareware fee? (i.e. £5, £10, or £15).
4. Why do FAST. bother? They have never caught anybody for pirating games.
5. Why not do away with FAST. and put the money they waste into something like dropping software prices?
6. Why have fancy packaging? Paying £24.95 sounds silly for a game on a disk.

MAIL SHORTS

Well Spotted!

In "THE TOP 100" you quote for ISSUE 64 that the UNIX systems will be adversely affected on 1-1-2000 and that UNIX can therefore only cope with the 20th century. May I humbly point out that the 21st century only starts on 1 Jan 2001 and may I therefore even more humbly conclude that UNIX does not even seem to be able to handle the 20th century!!

Fred Baptiste, Kilmarnock

Such devotion to detail Fred! But perhaps you'll be a little miffed to learn that the fiver you receive for spotting this deliberate mistake will, after inflation, be worth only £4.997p by the time you receive it.

AS

Footie Ref 2

Re: NCE, Issue 100, P.8 "Trevor Scores For Computer Footer" Oops! Someone, somewhere has made a mistake. Trevor Brooking was not Britain's first £1,000,000 player - Trevor Francis was. How about a copy for my trouble! (I've got a C64)

Adrian Maggs, Keynsham, Bristol

And Colin Campbell even put £10 on Aston Villa to win the League so that shows you how much he knows. A copy is on its way.

AS

FAST FACTS

I know someone who gives out pirated software, please give me the correct number of FAST for I have had no luck getting through to them and this has been going on for at least a few months, to the point that I've given up trying to call them.

Robodunce Mildmay Road London

Okay, Robodunce, the number you need is 071-240 6756

AS

Beastly Games

Did you know that if you make each letter of the alphabet a multiple of 6 starting with A - i.e.- A =6, B =12, C=18 etc, the word 'Computer' adds up to 666 ?

Damien

Mmmm! Did you know that if you take the number 666, divide it by 13, add 33, multiply it by 6.66 and add 13 three times it makes -  
AAAAARRGHHH!!!

AS

Let's put it in a big colourful box. There that looks better, we better make that £29.95

7. I and all the others I know NEED pirating. No pirates, no computer.

8. We keep other businesses going (i.e. Blank Disk Suppliers, Disk Editors, Mon-ST Etc Etc.

9. We BUY loads of hardware. (only 'cause you can't copy it)

10. Why does "Rob Northern" bother. The better he gets, the better the "Hackers" get.

11. Surely software houses only need to "edit" the sectors on a disk to stop it being copied. Why do they have to do elaborate techniques to their software codes. (i.e. Encryptions etc). This would stop high prices.

12. Only people who know what they are doing would copy the games easily. Therefore the loss would be minimum. "Lamers" would try it once, see that the disk won't copy then leave it.

13. Why do mags, like yours, let companies take £3 a time for Public Domain? Only because they advertise in your Mag.

14. EVERYBODY IS HERE TO MAKE MONEY. THAT'S WHAT IT'S ALL ABOUT.

15. Why does some yuppie working for a computer Mag say...."Tell FAST. the names and addresses of the hackers".... and "Only buy your games, never get pirated copies....". It's alright for them in there "steady, bags of cash" jobs. What about people with poor-paying jobs? Houses to keep? Families to look after? Don't say "You shouldn't have a computer then" that's not the answer.

16. I read once that "Pirating" would kill the computer industry. Shite, what about: CD, L.P's, Cassettes, 7", Videos, Taping from the radio. The ST and Amiga have to big a user group to let that happen.

Computer Freak Bonnie Scotland

More Jolly Rogering...

After reading "Xeers" letter in issue 100 about "SOFTWARE PIRACY", I felt compelled to write this letter as I don't think your mag should be a one-sided "PIRATES ARE THE SCUM OF THE EARTH" kind'a mag.

OK! Xeers, go forth and multiply! You must be a mega-lamer to even think about shopping anyone in! READ THE SMALL PRINT! 1,000 quid IF it leads to a conviction. As of yet, no-one who pirates software in the way you mean has ever been 'dun'. Also, if anyone finds your address you can be sure that you will be taken away and have the s\*\*t kicked out of you!

On the subject of piracy, all the 'AGAINSTS' are Bull! Most software programmers pirate their own stuff. Piracy has been going on for years, 'WHAT YOU NEVER HAD, YOU'LL NEVER MISS', so the programmers and software houses blaming piracy for s\*\*t sales can go w\*\*k themselves! Have they ever thought that the game might just be S\*\*T!!!!????

I would only buy good games. If I get a pirate copy of a game and like it, I'll buy it! That's life. Us pirates will take no bull about poor sales etc.. If ya wanna stop

piracy keep on making S\*\*T games, make a good game however, and the pirates will buy the original. You'll most probably think up some excuse to answer this, but the fact remains, most stuff on the ST is s\*\*T, not even a 3-year-old would pirate it! All the software houses pay thousands per year to FAST, they should use the money to get BETTER games-testers, programmers, musicians, game designers etc...  
THE KOPITE OF G-FORCE (ST DIVISION)

Well...this pair seem to have had a raw nerve touched by somebody somewhere eh?

If both are you are so hard why don't you include your addresses. No, not so I can shop you to FAST - but so I can come round and nick all your hi-fi, TVs, monitors and hardware. Can't see any difference myself.

I seem to remember a long, long time ago a series of correspondence in these pages where a certain bunch of lads from the Glasgow Barrowlands 'phoned up to offer to come down to Bath and break our legs for running a news story on the packets of money they were making from selling pirated software on market stores. At least Computer Freak and The Kopite are able to translate the same mentality into written words. But that's not saying much. I'm sick of all this "Games are too expensive therefore we're forced to pirate them" angle. Sure, games are expensive - and while the pirates out there are ripping them off they're going to stay that way.

As for The Kopite - Jeez you are warped! I'd be the first to admit that there's probably only half a dozen games released each year that are worth buying, but it doesn't seem to me that you have to pirate all the others to come to a decision over which one to buy. If I want to buy a rap album I don't go and copy every record of black music going back to Negro chain-gang singalongs do I? Seems to me it's a shame FAST isn't more effective then they might make an example out of people like you. In the meantime, Kopite, you might like to take your adolescent macho posturing some place else and grow up sucker.

AS

We're All Doomed

Yes, its me again "the Atari 8-bit user" as well as an STFM (single & double sided versions) for nearly 2 years and to tell you the truth I can't see any advantages in owning or even buying an ST or even an Amiga. Firstly the reason why I and other Atari 8-bit users chose the ST was because at the start Atari were pitching the ST at the Professional or Serious/business end of the computer market. Unfortunately the S/W houses didn't see it that way and started dumping S/W on the ST. (i.e. not the sort of S/W that the S.T was designed for) and the problem was that virtually all of the S/W (even today's) was based on concepts designed ten years ago.

Now just before you accuse me of saying that there shouldn't be any games on the ST or CBMs thing, what I am trying to say is what's the point of buying a 16-bit thing for games when you have just sold your 8-bit thing (I'm glad I haven't) which you refer to as a games micro?

Because all that is going to happen is

that more 'shitty' software will find its way onto the ST or Amiga and thus the business S/W co's will not be interested in writing programs such as Lotus 1.2.3., Magellan, Symphony etc, for the ST. or Amiga because the S/W games publishers & the games/micro mags refer to the ST/Amiga as games machines.

Why do you think that things like the above and the like of Aldus Pagemaker/Quark Xpress etc haven't ventured outside that of Mac(Apple) and IBM PC'S (and compat's)?

Carmel Andrews, London

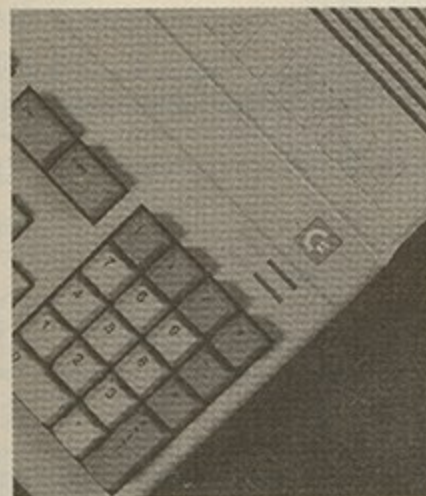

The Amiga will one day be a mere plaything says Carmel Andrews.

That's Okay...

Thank you very much for answering my letter and arranging for a copy of "Defender of the Crown" to be sent to me. I would also like to thank Mirrorsoft and Cathy Campos in particular for providing me with the game so quickly, I received it only a few days after I had written to you.

Thank you both again especially as I wasn't expecting a free copy of the game when I originally wrote. On to my other reason for writing, I'm sick of hearing people say "My Amiga is better than your ST" or "My 16-bit is better than your 8-bit". Everyone has a choice to what computer they buy and others should respect that choice and not slag off another person's computer. To anyone buying a new computer and that includes 8-bits and consoles, buy a machine that is suitable for your needs and don't be swayed by what someone else tells you. If you're a musician you could buy an Atari ST or if you're into arcade games you could buy a console or Amiga. But in the end the choice is yours alone.

One last point, you don't need 4,096 colours on screen at one time to make a great game. If the concept of a game is good then it will be on an Amiga. Don't judge a game by its graphics. Thanks for all your help and for providing such a good magazine.

Jonathan Menezes East Ham London

No thanks needed Jonathan. Maybe though this should be the last of the "I'm sick of the My Amiga's better than yours letters" because I'm sick of the "I'm sick of the My Amiga's better than yours letters. I'll have to have a word with Haydn when he's back from the USSR.

AS

## AMIGA SCREEN GEMS PACK

- A500 WITH 1.3 WORKBENCH
- 512K RAM & BUILT-IN 3.5" DISK DRIVE
- MOUSE + ALL MANUALS & CABLES
- CONNECTS TO ANY TV - MODULATOR INCLUDED. NOTHING ELSE NEEDED - JUST PLUG IN & SWITCH ON.

- **PLUS** FREE SOFTWARE:-
- BACK TO THE FUTURE II
- DAYS OF THUNDER
- SHADOW OF THE BEAST II
- KNIGHTBREED
- DELUXE PAINT II
- + FREE WEEKEND HOTEL ROOMS FOR 2\*
- + FREE INTRODUCTORY VIDEO WORTH £14.99

**ONLY £369.99 POST FREE**

ACCESSORIES PACK WORTH £30+ ONLY £19.99 WHEN PURCHASED WITH AN AMIGA. COMPRISES:- 10 SONY DISKS, MICROSWITCH JOYSTICK, MOUSE MAT & DUST COVER. \* Please ask for full details.

**AMIGA A500 SCREEN GEMS + PHILIPS CM8833 MONITOR**  
Includes Complete Screen Gems pack as above.

Monitor spec.

- 14" SCREEN
- MEDIUM RESOLUTION
- OVER 4096 COLOURS
- RGB & VIDEO INPUTS
- TWIN STEREO SPEAKERS
- STEREO HEADPHONE SOCKET
- GREEN SCREEN SWITCH
- CONNECTING LEAD

**ONLY £599.99 POST FREE**

## A500 1/2 meg UPGRADES

**NOW ONLY £34.99**

- 1/2 meg RAM CARD - ALL CHIPS SOCKETED.
- ON/OFF SWITCH
- LOW POWER RAM CHIPS
- FULLY TESTED
- EASY TO FIT

**WITH CLOCK & BATTERY ONLY £39.99**

**\* AN INCREDIBLE £10.00 CHEAPER IF BOUGHT WITH AN AMIGA \***

## 3.5" EXTERNAL DRIVES

**NOW ONLY £59.99**

- 880K FORMATTED, 1 MEG UNFORMATTED
- THROUGH PORT
- ON/OFF SWITCH
- LOW POWER CONSUMPTION
- COMPACT METAL CASE
- VERY QUIET, VERY RELIABLE

**5 1/4" EXTERNAL DRIVES ONLY £99.99**

**1meg of RAM FREE !**

**COMMODORE A590 HARD DRIVE + 1MEG RAM FITTED**

**ONLY £399.99**

**A590 + 2MEG ONLY £439.99**

**1 Meg A500**

**SCREEN GEMS PACK**

**WITH 1meg RAM fitted.**

**ONLY £394.99**

**1 Meg A500**

**SCREEN GEMS PACK**

**WITH 1meg RAM + 3.5"**

**EXTERNAL DRIVE**

**ONLY £449.99**

## FREE VIDEO !

Our specially produced & very helpful "INTRODUCTION TO THE AMIGA A500" video worth £14.99 comes free with any Amiga pack.

It covers in detail, & step by step, *all the first time buyer needs to know* to get their A500 up & running, as well as other essential operations such as backing up workbench, as well as how to connect & use external drives, & ram upgrades etc. Available separately for £14.99 + 75p postage. HS format only.

## FREE MIDI INTERFACE

**WITH MUSIC X & MUSIC X Jnr**

**MUSIC X v1.1 (new version) + FREE MIDI 2 INTERFACE - ONLY £129.95**

**MUSIC X JUNIOR + FREE MIDI 2 INTERFACE - ONLY £79.95**

Midi leads extra - 1m long £1.99, 2m long £2.99, 3m long £3.99, 5m long £5.99

Our MIDI 2 Midi interfaces feature Midi in, Midi Out, Midi Thru sockets + 2 separately switchable out or thru sockets. (Rrp £34.99) As supplied to Commodore - thousands sold to date.

## SILLY PRICES!

**1/2 meg RAM CARD + 3.5" 1meg EXTERNAL DISK DRIVE**

**ONLY £84.99**

**1/2 meg RAM CARD with clock/battery + 3.5" 1meg EXTERNAL DISK DRIVE**

**ONLY £89.99**

**NOW YOU CAN RUN PC SOFTWARE ON YOUR A500.**

KCS PC/XT BOARD for A500 Fits in 1/2meg ram card slot, gives Amiga 1meg ram & battery backed clock. Most PC software runs faster than on many PC/XTs.

**IMPRESSIVE & ONLY £319.99**

**FREE FANTAVISION SOFTWARE WORTH £18.99**

## THE NORTH'S COMPUTER DISCOUNT CENTRE

CALLERS WELCOME.

OPEN 8am - 7pm Mon - Fri. 8-4pm Sat

## THE FABULOUS NEW STAR PRINTERS

PRICE INCLUDES VAT, CABLE & DELIVERY

**LC200 7 COLOUR 9 PIN ...£249.99**

This new 9 pin 7 colour printer features 180cps draft speed & 45cps NLQ speed. 4 fonts + italics, paper park, friction & top & bottom tractor feeds, A4 landscape (sideways) facility & front panel dip switch control. It has a 16k buffer.

**LC24-200 24PIN MONO .....£294.99**

**LC24-200 24PIN COLOUR ..£339.99**

These new 24 pin printers feature 200cps draft speed & 65cps NLQ speed. 5 fonts + italics, paper park, friction & top & bottom tractor feeds, A4 landscape (sideways) facility & front panel dip switch control. The colour version has a 30k buffer, the mono one, a 7k buffer.

## 4MEG RAM CARDS

LOW COST, INTERNAL FITTING

This 4meg A500 memory expansion system is compatible with both old & new Agnus chips, & workbench 1.2 & 1.3. Ram can be configured as fast ram & chip ram. Fits into 1/2 meg slot, but Gary chip adaptor requires internal fitting which will invalidate your warranty. Features battery backed clock, fully socketed - expand in 512k steps using standard 256\*4 D rams. No soldering required. Comprehensive instruction book & utility disk included.

**UNPOPULATED 4MEG CARD ..£99.99**

**WITH 1MEG .....£139.99**

**WITH 2MEG .....£179.99**

**WITH 3 MEG .....£214.99**

**WITH 4 MEG .....£249.99**

**NO HIDDEN EXTRAS - ALL PRICES INCLUDE VAT & P&P**

**PRINTERS & MONITORS. Prices include free cable.**

PHILIPS cm8833 STEREO ..... £239.99

COMMODORE 1084SD ..... £249.99

STAR LC10 ..... £155.99

STAR LC10 COLOUR ..... £199.99

STAR LC24-10 ..... £239.99

CITIZEN SWIFT 24 COLOUR ..... £339.99

CITIZEN 120D ..... £139.99

COMMODORE MPS1230 ..... £147.99

## OTHER PERIPHERALS

DIGIVIEW GOLD V4 ..... £119.99

VIDI + VIDICHROME ..... £109.99

MARCONI TRACKERBALL ..... £54.99

NAKSHA MOUSE ..... £29.99

MINIAMP 4 STEREO SYSTEM ..... £44.99

STEEL MONITOR STAND ..... £24.99

MONITOR STAND WITH SHELF. £32.99

TWO WAY MONITOR SWITCH ... £15.99

STEREO SAMPLER MK II ..... £39.99

XCOPY PROFESSIONAL INCLUDING

CYCON ADAPTOR new version £37.99

PLEASE ASK FOR FREE AMIGA SUPERMARKET CATALOGUE.

## HOW TO ORDER.

BY PHONE ON ACCESS OR VISA

BY MAIL - SEND CHEQUE OR PO MADE PAYABLE TO TRILOGIC.

PROMPT DESPATCH. C/CARDS NOT CHARGED UNTIL GOODS DESPATCHED.

NEXT DAY DELIVERY £6.00 EXTRA (UK MAINLAND, excluding SCOTTISH HIGHLANDS)

(Cheques must clear before goods despatched) PRICES CORRECT AT TIME OF GOING TO PRESS. E&OE.

**SALES HOTLINE - 0274 - 691115**

ENQUIRIES - 0274 - 678062 . FAX - 0274 - 600150

**TRILOGIC, DEPT CE, UNIT 1, 253 NEW WORKS ROAD, BRADFORD, BD12 0QP**

Established 1984



# NEW AMIGA ASSEMBLER

## PAGESTREAM 2

# ATARI'S PRAYER

ALL IN WHOLE WIRED WORLD ON PAGE 32

AND STARTING THIS WEEK

# THE EXPRESS EXTRA SERVICE GUIDE TO BARGAINS

# SHOPPING EXPRESS

THE VALUE-PACKED GUIDE TO YOUR MACHINE AND MORE

## CONTENTS

<b>AMIGA</b> .....	18
An A2000 for the 90s	
<b>ARCHIMEDES</b> .....	19
Making the most of your mouse	
<b>CPC</b> .....	20
Shadow of the Beast is here!	
<b>C64</b> .....	22
Drive yourself Batty	
<b>PC</b> .....	24
Shareware fractal chaos!	
<b>Spectrum</b> .....	25
It's all Child's Play	
<b>ST</b> .....	26
Guess the price of an 600Mb optical disk	
<b>Macintosh</b> .....	27
Can't afford a new one? - how about buying second-hand?	
<b>Whole Wired World</b> .....	32
Steve Gold at large	
<b>Circuit City</b> .....	35
Control multiple machines with just one mouse!	
<b>Centrefold</b> .....	36
A truly transatlantic flavour this week with Terrible Tim	
<b>Express On-line</b> .....	56
The weekly bulletin board and user group guide	
<b>Express Extra Service</b> .....	59
The first of a monthly guide to auctions and second hand prices	
<b>Tech Tips</b> .....	60
Advice on your problems	
<b>The PD Column</b> .....	62
The best in free software	

# FREE! Reader Ads Order Form

PLEASE TICK THE CATEGORY YOU WANT YOUR AD TO GO IN:

- |  |  |  |                                   |
|--|--|--|-----------------------------------|
| <input type="checkbox"/> HELP OFFERED  | <input type="checkbox"/> GOODS WANTED  | <input type="checkbox"/> BUGS DISCOVERED | <input type="checkbox"/> EVENTS   |
| <input type="checkbox"/> SERVICES      | <input type="checkbox"/> VIRUS WARNING | <input type="checkbox"/> FOR SALE        | <input type="checkbox"/> PERSONAL |
| <input type="checkbox"/> ANNOUNCEMENTS | <input type="checkbox"/> MINI-TIPS     |  |                                   |

NAME \_\_\_\_\_ TEL: \_\_\_\_\_

ADDRESS \_\_\_\_\_

WRITE YOUR FREE AD HERE

\_\_\_\_\_

\_\_\_\_\_

\_\_\_\_\_

\_\_\_\_\_

\_\_\_\_\_

\_\_\_\_\_

Send your reader ads to:  
SHOPPING EXPRESS READER ADS,  
30 MONMOUTH STREET, BATH BA1 2BW

## Terms and conditions

- Sorry, NO trade ads. All reader ads must be from private individuals
- We cannot vouch for the quality of goods and/or services offered in this section. All ads are accepted in good faith.
- We reserve the right to amend or refuse reader ads at our discretion
- No pirated software may be sold through these columns. Any reader being offered non-originals should contact us
- We cannot guarantee that reader ads will appear in particular issues of Express
- The following declaration should be signed:

My advertisement conforms to the terms above and is legal, decent, honest and truthful

Signed \_\_\_\_\_

**SCOOP  
PURCHASE****RANK  
XEROX****LASER PRINTER 4045R****With inbuilt photocopier**

- \* **10 pages minute**
- \* 512kb & 1Mb RAM versions
- \* Emulations: HP Laserjet +, Diablo 630  
8 Xerox 2700, (FX80/IBM pro available)
- \* Resident Font range
- \* Plus 4 Font Cartridge Slots
- \* Fonts Cartridges & Memory upgrades available
- \* Downloadable Fonts (from Floppy disc via PC)
- \* Interfaces: Parallel (Centronics) & Serial (RS232)
- \* Digital status display
- \* Test Print out on power-up
- \* 250 sheet input tray
- \* 'Non-Cartridge' inexpensive Toner
- \* 4 Toner refills supplied - 16000 copies inclusive!
- \* Easy to set-up Configuration cartridge
- \* Accessory Pack included - full of useful extra's

3 months on-site warranty, by Rank Xerox  
Maintenance Contracts and Service Available

**FROM £650 + VAT**

NEXT DAY DELIVERY & INSURANCE £30 + VAT

ORDERS TAKEN BY PHONE USING  
ACCESS OR VISA FOR NEXT DAY DELIVERY

**PHONE: 081 330 7533**

**FAX: 081 330 4838**

## **COMMONSIDE HARDWARE SERVICES**

Unit 13, 193 Garth Road, Morden,  
Surrey, SM4 4LZ

# Amiga

### **A2000 FOR THE 90S**

After the recent news that Commodore may drop the current Amiga 2000, I recently heard rumours concerning the machine's replacement. According to a source in the States, Commodore is working on a 32-bit version of the 2000, based around the 68020. OK, Commodore already has a 68020-based 2000 in the shape of the A2500, but rumour has it that this machine will be a true 32-bit computer, just like the A3000.

The new machine will come complete with ECS, OS version 2.0, the A3000 display enhancer and 2Mb of 32-bit RAM. According to my source, Commodore may even re-case the machine in a 3000-like system box. We can but hope.

Speaking of future developments, it seems that the Commodore A500-Professional - complete with ECS and *Workbench 2.0* - is definitely happening. I recently spoke to a developer who had contacted Commodore after reading the story in *Express 97*.

Although Commodore officially told us that the story is nothing more than 'speculation and hype', it confirmed to my developer source that the story was completely true. Furthermore, it seems that we may well see the new machine in time for a Christmas launch.

### **A1500 PRICE SLASHED**

Checkmate Digital has just announced a substantial price cut for its popular A1500 case conversion kit for the A500. As you will know, the A1500 transforms the A500 with its impressive expansion capabilities. Not only that, but it also provides A500 owners with a detachable keyboard, just like the 2000 and 3000 Amigas. The kit is now being sold by Checkmate for just £199, which certainly seems to be good value for money.

For those of you who still can't afford the full kit, Checkmate has finally started shipping its keyboard conversion kit for the A500. This £60 kit brings the A500 keyboard out of its case and mounts it inside the same case as used by the A1500. The remaining hole is then covered with a blanking plate. The keyboard is then attached to the machine via a curly cable. For more, give Checkmate a call on 081-909 3885.

### **MONEY MATTERS**

Microdeal has finally released an Amiga version of its *Personal Finance Manager* program, a sophisticated personal finance program that was originally released on the Atari ST more than 2 years ago.

The program was written by none other than Dan 'Allad Jones' Lennard, the programmer responsible for Microdeal's recent *Quartet* Amiga sample sequencer. Dan - who no doubt put the money he earns from *PFM* towards that Lotus Turbo Esprit he's been promising himself for so long - has been hard at work fine-tuning *PFM* to take advantage of the Amiga's

increased graphics capabilities. *PFM* provides an easy way of looking after all those various bank and building society accounts, credit cards etc. As Microdeal says, using *PFM* is as simple as filling in a few forms (but we all know how complicated forms can be, don't we readers?). Anyway, look out for a full review in next week's *Express*.

### **200 MBYTES**

Do you feel held back by your A590? Is 20Mb just not enough? For those of you who yearn for true 'power computing', Checkmate Digital has the answer with what could easily be described as the ultimate upgrade for the A590.

For just £499, Checkmate will fit a 200Mb SCSI hard-drive inside your A590. The drive offers an average access time of 15 ms, which is pretty damned quick (especially when you consider that the 20Mb Commodore drive fitted to the A590 has an access time of 88ms!). Even if you don't own an A590, the drive will also work fine with any standard SCSI interface.

If you're feeling rich, Checkmate can offer a complete hard drive system consisting of a 200 Mb A590 fitted with 2Mb of fast RAM for £900 (although the price may well have dropped by the time you read this!). For more, give Checkmate a bell on 081-909 3885. I'll be the first in the queue for this one!

### **DEVINE SPIRIT**

Rumour has it that Spirit Technologies is soon to release what could easily be the best value Amiga A500 memory upgrade yet. For £300, Spirit's new board offers 2Mb of fast RAM. OK, nothing special so far, but just get this - the board also comes as standard with a built-in SCSI interface and a 68881 maths co-processor! No release dates yet, but rest assured that you'll hear them first from *Express*! In the meantime, more can be extracted from *Bytes & Pieces* on 0253 734218.

### **PD NEWS**

Want to know what's hot in the world of Public Domain software? If so, then a new publication - produced by leading PD suppliers, George Thomson Services - could well be for you. *PD News* is packed with news and views about everything that's going on in the world of PD. It features reviews of the latest PD, plus letters and even a PD question and answers page for those of you who are having problems with PD programs. The good news is that it will cost you little more than 50p! For more, give GTS a call on 0770 82212.

### **PICTURE THIS!**

So you've got a friend who has an ST, and you want to swap pictures, eh? Well matey, here's how it's done. Before you can convert any picture file, you'll obviously have to bring the file across from the Atari onto an Amiga disk. The easiest way of doing this is to get your hands on a very useful utility called *CrossDOS* (£29.95 from Power Computing on 0234 273000). This allows you to read Atari (and PC) format

disks on an Amiga.

Next, the conversion process itself. If you wish to convert a Neochrome picture to IFF, then you need a package called PIXmate from Progressive Peripherals & Software. PIXmate can handle Neochrome images in both high and medium resolutions.

If the picture is in Degas format (not compressed DegasElite), then you can convert it to IFF with a PD program called IFFConverter. I haven't actually seen this on offer in this country, but you can get it by buying the latest issue of Newsflash, the Amiga's premier disk magazine (ask for disk 13). This handy little program will happily read Degas files and convert them to both IFF and AmigaRAW format. Newsflash is on

0924 265593.

But what if you want to give some Amiga pictures to your ST friend? Well, providing your friend has either DPaint ST or Degas Elite (both from Electronic Arts), then they can already load IFF files directly. DPaint is the best bet though, as it can read and write both compressed and uncompressed IFF, whereas poor old Degas can only handle uncompressed IFF.

Pictures with no more than 16 colours can be ported straight across without modification, but if you're porting pictures with 32 colours or more, then you'll need to knock them down to 16 colours using an image processing package such as PIXmate.

Jason Holborn

# Archimedes

## MARIARTI

He prods it suspiciously before pronouncing, 'Look!, it's an Archimedes game. I haven't seen one of these since, um...' He unpacks it, fires it up, and decides, 'It's a port, see, 'cos it only fills two thirds of the screen. Good fun though, innit.'

Yes, it is. *Mad Professor Mariarti* is really just platforms and ladders, with a few dinky puzzles thrown in. You play the balding Prof, running about the laboratory with much on your mind. There are five different lab rooms within which to rid of nasties like deadly wandering calculators, drunken chemistry flasks, gormless vegetables and so on. Weapons have to be bought from a machine, using the coins that are scattered around the place, and there are interesting looking switches and buttons for 'beep victims' to press.

It is just a little too easy: with a few hours concentrated playing you can finish the whole thing. But the graphics are clear and neat, the play is diverting and none of the puzzles are too taxing — except perhaps what to do with the jam jars. The soundtracker score is pleasant, with different tunes for different rooms, so none become too grating. There are a couple of cute touches. First is the game icon, which shows something of the Jeckyl and Hyde character of the professor when you select it. Second, if you ignore the game for a while, the prof cleans his specs then taps impatiently on the screen, with a wonderful 'inside the glass' sound. The whole game has a bizarre and humorous air about it.

Conclusion: a bob short of 20, but possibly the best platforms and ladders on the Arc since *Chuckie Egg* under the emulator. It's rivalled only by *Terramex*, from the same author.

Krisalis, the publisher, is on 0709 372290.

## MOUSE MADNESS

It's self-evident that three buttons are better than two or one. Just count the buttons on Britain's trendiest Levi's if you disagree with me. Yup, five on my pair too. Less is not more, though to be fair to Walter Gropius, I don't believe he was thinking of mice at the time. So this week, it's the first in a series of 'mouse

specials'. Part one is entitled '10 things you had no idea you could do with the Adjust button'.

(1) On the desktop, Adjust on the zoom box (top, right of a window) zooms the window without bringing it to the front. You can move a window 'under' another by using Adjust to drag its title bar. So using Adjust moves the window 'without' bringing it to the front.

(2) Adjust, on a scroll icon or next to the scroll bar scrolls the document the opposite way — so Adjust on the Down arrow scrolls upwards.

(3) Adjust on the Close icon (the X at top left) closes a filer window but opens its parent — the equivalent of \*DIR. Also, double-click Adjust to open a directory and close its parent — useful to avoid having 19 filer windows open at once.

(4) In Paint, you can often draw in the background colour — for example with the pen of sprite brush tools. In fact, the 'background colour' is the first colour in the palette, usually white.

(5) With circle or rectangle tools, Adjust allows you another go at the last point — so you can move the centre of a circle that you haven't quite got right.

(6) In Draw, while you have any tool other than Select or text, clicking with Adjust allows you to edit the points in an object.

(7) In Edit and many other text editors (Impression, Ovation etc), Adjust will select the text between the cursor and where you click — so it's ideal for selecting blocks bigger than you can fit on the screen. Put the cursor at the beginning of the block, scroll with the scroll bar and click Adjust at the end of the block.

(8) In PrinterDM and other printer drivers, it allows you to step backwards through the list of available printers. Click Select on the printer icon to see this dialogue box, then Select or Adjust on the name of the printer.

(9) Back on the desktop, you can select several files at once for deleting, copying and so on. Use Select for the first file, but use Adjust to add to the selection.

(10) Choosing a menu item with Adjust rather than Select often makes the menu remain on screen, ready for a second selection. For

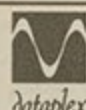

## DATAPLEX COMPUTERS LTD.

129 Bath Road, Slough, Berkshire, SL1 3UW  
19 High Street Swindon, Wiltshire

Tel: 0753 35557 Tel: 0793 488448

SHOWROOM open: Mon - Fri 9.30 - 5.30 Saturday 9.30 - 4.30 MAILORDER Consumables £1.50 Hardware £8.00 Prices excluding VAT

### AMIGA A500 HARDWARE

Amiga A500 Batman Pack + free box of disks .....£317  
Amiga A500 Flight of Fantasy + box of disks .....£317  
Amiga A500 Screen Gems Packs + free disks .....£317

### SPECIAL OFFER

Amiga A500 1Mb Pack - Choose any Amiga A500 from above and we will give you 512K RAM + clock, mouse mat at only ....£355  
Amiga Class of 90's .....£439

### ATARI COMPUTERS

Atari 520STFM discovery pack includes 4 games .....£240  
Atari 520 STE Turbo Pack includes basic STOS and 7 games .....£310  
Atari 1040 STE extra pack includes ST Words, ST Calc, ST Basic, ST Graphics, Hyper-Paint, STOS, 1st Basic, Print Game .....£399

### AMIGA/ATARI DRIVES

1 Meg 3.5" internal .....£49  
1 Meg 3.5" external .....£60  
1 Meg 5.25" external .....£90

### ACCESSORIES

512K Ram + clock .....£45  
Joystick .....£10  
10 Blank disks in library box .....£6  
Mouse Mat .....£3  
Naksha Mouse .....£32

### MONITORS

Philips CM8833 - Colour Monitor + leads only .....£189  
SM 1224 (Atari) .....£205  
SM 124 (Atari) .....£85

### PRINTERS

Star LC10 Mono .....£129  
Star LC200 Colour (9 pin) .....£180  
Star LC24 200 (24 pin) .....£219  
Star LC24 200 Colour .....£259  
Panasonic KXP1124+ lead .....£199  
Panasonic KXP1624 .....£329  
Citizen 120D + .....£120  
Citizen 124D .....£189  
Citizen Swift 24 + Colour Upgrade .....£265  
Citizen Swift 9 + Colour Upgrade .....£185  
Epson LX400 .....£526  
Epson LQ400 (24 pin) .....£199  
Epson LQ 500 .....£269

### RIBBONS

PLEASE CALL FOR PRICES

## COMPUTER UPGRADING BARGAINS

### AMIGA A500

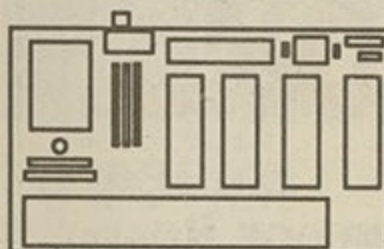

- ★ Increase RAM from 1/2Meg to full 1 Meg
- ★ Small board design
- ★ Real-time clock with battery back-up
- ★ Off/on switch

**ONLY £37.50**  
without clock £33.00

### ATARI STE

Fantastic Prices!!

#### Easy to install RAM EXPANSION

- ★ Upgrade 520STE to 1Meg (2x256 Simms) .....£39
- ★ Upgrade 520/1040 to 2Meg (2x1Meg Simms) .....£110
- ★ Upgrade 520/1040 to 4Meg (4x1Meg Simms) .....£230

### AMSTRAD

- ★ Model 1512 RAM Upgrade to 640K .....£21
- ★ For super speed calculations the INTEL 8087-2 (8MHz) Co-Processor ..£87
- ★ For higher performance, replace your 8086 cpu with the NEC v.30 8 Mhz.£15  
Kits supplied with instructions

#### PRICES INCLUDE VAT AND CARRIAGE

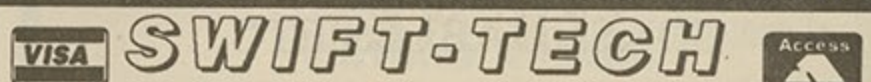

Open up to 7.00pm Mon- Sat

Tel: 0480 811805

37a High Street, Offord Darcy, Cambridgeshire, PE18 9RF

# MICRODIAL

## ATARI

520STFM DISCOVERY PACK .....	£279.00
520STE TURBO PACK .....	£369.00
1040STE BUSINESS PACK .....	£460.00
PORTFOLIO .....	£229.00
LYNX .....	£165.00

## COMMODORE

500 SCREEN GEMS .....	£369.00
A500 FLIGHT OF FANTASY PACK .....	£369.00
A500 CLASS OF THE 90'S PACK .....	£515.00
M501 1/2 MEG UPGRADE INC CLOCK & GAME .....	£75.00
C64 WORLD CUP PACK .....	£150.00
PC STARTER PACK .....	PLEASE PHONE

## PRINTERS

STAR LC-10 .....	£169.00
STAR LC-24/10 .....	£249.00
MANNESMANN TALLY MT81 .....	£147.00
CITIZEN 120D .....	£125.00
SEIKOSHA SP2000 .....	£199.00

SOFTWARE UP TO 20% OFF RRP

THIS IS A SMALL SELECTION OF OUR WIDE RANGE - PLEASE PHONE - WE WILL TRY TO MATCH ANY PRICE

All prices include VAT and P&P, Courier Delivery add £8.

Please make cheques, P.O.'s payable to "MICRODIAL" and send to:

THE OLD CAMP SHOP, WARRINGTON LANE, ADGEN WHARF, LYMM, WARRINGTON, WA13 0SW.

All items are subject to availability, prices are subject to change without notice. All goods despatched upon cleared payment. Proprietors: Mike Todd and Mal Neary. E. & O. E.

24 HOUR ORDER LINE 0925 75 7696

# COMPUTER AUCTION

**SATURDAY 17TH NOVEMBER AT  
BOWLERS, LONGBRIDGE ROAD,  
TRAFFORD PARK, MANCHESTER.  
SALE STARTS 11.00AM  
VIEWING AND TESTING  
FROM 8.30AM**

About 1000 lots of equipment incl:  
IBM, COMPAQ, TOSHIBA, APRICOT,  
AMSTRAD, EPSON, AND OTHER  
IBM COMPATIBLES. HOME  
COMPUTERS, APPLE EQUIPMENT,  
SOFTWARE, PRINTERS, HARD  
DISKS, MODEMS, MONITORS  
CONSUMABLES ETC.

FOR YOUR CATALOGUE RING  
COMPUTER CONNECTIONS ON 0254 81 3316  
PS Ring should you have immediate requirements for VGA Cards,  
IBM PS 2's, COMPAQ, IBM, POSTSCRIPT, LASER ETC.

example, in Draw, you can group two objects and justify them in a single menu operation.

Next week, 'Whacky ways with the Menu Button'. As the trolls say in Norway, 'I can hardly contain my excitement' (though of course they say it in Norse).

## TO BALDLY GO

If you're at all technically minded, whether you just watch Star Trek, or have a real interest in astronomy, then *Orrery* is for you — even at £109. Pop down the local astro-software emporium this weekend and buy it.

An orrery was an eighteenth century clockwork model of the solar system — peas and pinheads representing planets stuck on the hands of a complex clock, all rotating at the correct speed around the sun in the centre of the clock dial. The artist, Joseph Wright of Derby, painted a famous picture of one.

Spacetech's *Orrery* application is a little less beautiful to look at, but no less intricate than the eighteenth century clockwork masterpieces. It presents you with a picture of the night sky, exactly as it would look if you went outside, with stars, planets, outlines of the constellations and so on. It takes the real-time from the Arc's clock. You can pick another specific time, and the display will adjust to show the sky as it would appear then. Want to see what stars the survivors from the Titanic gazed up at? What will the sky look like on your next birthday? Just dial in the location, time and date! Or you can animate the display at any speed, from a minute at a time to several years per frame, to show stars wheeling across the sky. There's a tape-deck-style

control panel for this. Like time-lapse photography, the effect is breathtaking — the sky even slowly turns light blue as it gets light in the morning.

On the display, you can point at a star or planet and *Orrery* will give you further details, including digitised picture of the planets. As an aid to skywatching, the only problem is 'How can I get my Arc out in the garden?' There are other views too, looking inwards from outside the solar system. You can superimpose outlines of the constellations on the sky, incorporate an artificial horizon and show a grid of declination and right ascension on the sky to aid setting up your telescope. Finally, you can save a Draw file of the sky map.

My only complaint is *Orrery's* speed, or lack of it. Not the speed of animation — that's as fast as you can reasonably expect. But it's a little unresponsive in window movement and in popping up menus and this can become a little tiresome. It's written in BASIC, so perhaps it could be compiled to give a little more vim, but then it might not run in a 1Mb machine. Top marks to Spacetech, which can be reached on 0305 822753.

## COMING SOON

Christmas is still months away, but already I'm snowed under. *Arclight*, *Raytrace*, *Interdictor 2*, direct drive laser printers, boxes of chocolates and so on and so on... Well, I suppose they'll all just have to wait. Schema's manual has now gone to the printer's, so it'll be ready soon, together with Clares' DTP prog, *Tempest* ('gosh, is that the time') and many many more. You'll hear about them soon.

Ken Coumarin

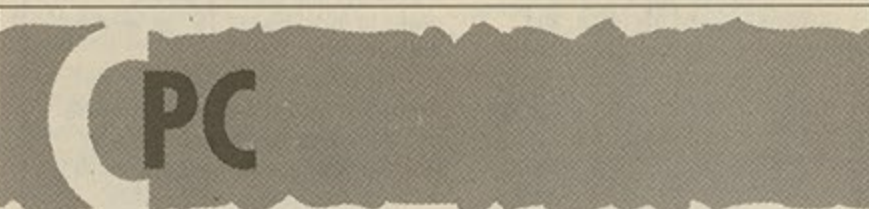

## COMPATIBILITY PROBLEMS?

We've had a couple of games arrive at the office recently which load up OK on our 464 and 6128, but take a distinct dislike to the resident 6128 Plus. Worrying, eh? Loricels' *Harricana* is one.

The disappointing thing is that the whole point of Amstrad 'sealing off' the enhanced hardware in the new machines was — supposedly — to make it possible to completely rule out the risk of any incompatibility with existing CPC software.

Well we already knew that certain 'clever' software didn't work, like Goldmark's *Nirvana*, for example, but we had hoped that would be the end of it. From now on though, we're going to have to make sure that all new software will indeed run on the Plus. To be fair, the vast majority that we've had in since we got the machine does.

The only significant difference (that we know of so far) between the new Plus and the old CPC is in the way the ROM is arranged. And, providing programmers have used Amstrad's jump block system correctly, there will be no problems. Where they've 'cheated', however, trouble may well occur.

## CONSOLE JOYSTICK

Within weeks of the announcement of Amstrad's GX4000 and Plus models, joystick maker Cheetah has come up with a model designed specifically for these machines.

Unlike the CPC, these cartridge-players need a joystick with two Fire buttons. Of course, you get the game paddles with the two machines, but many gamers still prefer joysticks, and while existing 'sticks will more often than not work fine, some of the new software does require two buttons.

Cheetah's new GX4000-compatible joystick actually has four buttons! Two correspond to button A, two to button B. The device is also designed to be used by both left and right-handed players.

Best news of all has to be the price — a mere £9.99! You can get in touch with Cheetah on 0222 555525, or write to: Cheetah International Ltd, Norbury House, Norbury Road, Fairwater, Cardiff CF5 3AS.

## SHADOW OF THE BEAST

*Shadow of the Beast* was the Psygnosis game that left visitors to the PC Show last year gaping when they saw it



• You've no vitality left, so if you don't shoot that middle missile you're a goner.

running on the Amiga. It's multi-level parallax scrolling, incredible backgrounds, sprites and animation pretty well set new graphical standards overnight.

Mind you, when it came to the reviews, testers soon established that the gameplay wasn't quite as earth-shattering as the graphics. It was very tough, and not particularly original. Nevertheless, it was still a milestone in gaming folklore.

Well, *Shadow of the Beast*, the Amstrad version, is finished – and I've been playing it for most of this week. It's now been licensed by Gremlin, of course, and the question on everybody's minds must be how successfully could the company convert a game which relied so thoroughly on 16-bit graphics onto an 8-bit micro?

Very successfully indeed, as it happens. Initial impressions are a bit mixed, as although the main sprite is detailed and well-animated, the background is a bit dodgy. The programmers have attempted to shade the sky and foreground, even though they're using the Amstrad's four-colour mode, and it doesn't really work.

Get below ground on subsequent levels, however, and things get much better. The screen is distinctly monochromatic; but the use of the higher-res screen mode pays off handsomely. There may not be the same breathtaking colours as on the Amiga version, but Gremlin's game is very highly detailed, with good animation and scrolling (which jerks only occasionally). The main thing is, that the very strange and instantly-recognisable main character has made the transition to the Amstrad very well indeed – bringing much of the atmosphere of the original along with it.

*Shadow* is essentially just another scrolling exploration/collecting/killing game. What sets it apart from the rest, however, is its combination of excellent graphics, large game-playing area (it comes on both sides of a 3-inch disk) and steadily-escalating difficulty level.

There is one huge bad point, however. When you die you go back to the start, no matter how far you'd got! Nasty, nasty. One collision or blow from an enemy doesn't kill you though. You start out with the ability to take 12 hits before you croak, and various potions and power-ups can be found along the way.

The variety of enemies is great, and the game follows the route of the original very closely. Giant flying and walking insects need careful timing to punch into oblivion, while the large bats that appear periodically are even nastier. Later on, you'll have to judge your timing to perfection to get past huge spiders dangling from ceilings, giant bouncing eyeballs (!) and dragon heads and tree roots thrusting suddenly from floors and ceilings.

There are end-of-level guardians to contend with too, each of which needs a special weapon, available somewhere else on that level, to defeat it. Keys, spanners and other objects lurk in dark corners too, and are needed for later stages in the game.

*Shadow of the Beast* is a very unusual game. The Amstrad's four-colour mode was a bold choice for Gremlin but a very successful one, to produce a very good game in its own right. Amstrad *Shadow of the Beast* still isn't perfect, but it's still worth the asking price – which is £12.99 on cassette, £15.99 on disk! That stings, doesn't it? I still say you won't regret it, though.

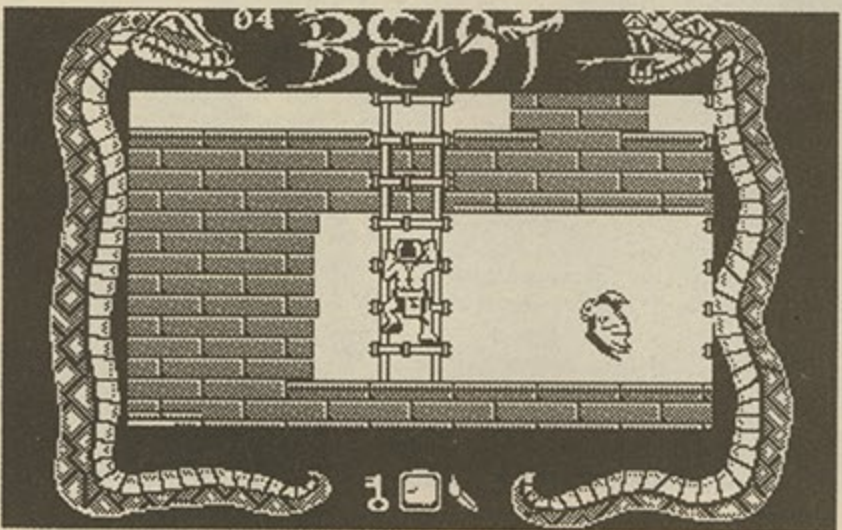

• Watch out for that bat – you can't punch while you're shinning down ladders.

## BLITTERCHIPS

P.O. BOX 64 KEIGHLEY BD21 4NB  
TEL/FAX (0535) 667469  
10am-7pm Mon-Friday 9am - 4pm Sat

### PRICE BLITZ

**L** ON AMIGA PUBLIC DOMAIN  
**O** 1-4 DISKS ONLY £1.15 EACH  
**O** BUY 5 DISKS OR MORE  
**O** ONLY 95 PENCE EACH  
**K** ORDER TEN OR MORE  
**CHOOSE ANOTHER FREE**

**SPECIAL OFFER TO ALL NEW CUSTOMERS**  
SEND A STAMPED ADDRESSED ENVELOPE (33 pence) FOR OUR LATEST LISTS OF OVER 500 P.D. DISKS AND YOU CAN CHOOSE YOUR FIRST DISK FROM US **ABSOLUTELY FREE** FROM THE LIST OF DISKS BELOW.  
Elvira (game demo), Amos (game creator demo), Puggs in Space demo, Digital Concert 4 (Music Disk), Dexton Mega Demo, Fillet The Fish (animation), Space Ace (game demo), Colossus (Text Adventure)

**SEND FOR YOUR FREE LIST AND DISK TODAY**

Blitterchips "Cliffe House", Primrose Street, Keighley, West Yorkshire BD21 4NN



OFFER APPLIES TO U.K ONLY  
MAIL ORDER ONLY  
SORRY AMIGA PD ONLY

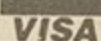

## Magnetic Media

**AMIGA PUBLIC DOMAIN  
BLANK DISKS FROM 37p  
EACH INC VAT  
PD:- £1.80 each or  
£16.50/10 inc VAT**

**A small selection from  
our vast range**

359/360 Star Trek 3	1 Meg
443 Coma Demo	1 Meg
444 Dope Intromaker	0.5 Meg
445 Magnetic Fields Music	0.5 Meg
453 Cryptic UK Demo Comp	0.5 Meg
459 Time Circle Demo	0.5 Meg

**SPECIAL OFFER! ALL 7 DISCS - £11.50**

Postage Inc  
**VICTORIA ARCADE,  
ALDERGATE, TAMWORTH, STAFFS  
S79 7DL TEL: 0827 59566**

# COMPUTER REPAIRS

**G B SYSTEMS — LINK**  
**The Repair Specialists**

- Sinclair ..... 16K,48K,128K,+1,+2,+3
- Commodore ..... VIC20,16,64,128,Amiga
- Amstrad ..... 464,664,6128,8256,8512,9512
- Acorn ..... Electron,BBC,Master,Archamedies
- Atari ..... 400,800,ST520,ST1040

All the above are on a fixed labour charge plus the cost of the parts

IBM..... PC,XT,AT,PS2

Amstrad ..... 1512,1640,2086,2286,2386

IBM Clones ..... Any make / model undertaken

The above are charged on a hourly rate

Most printers and monitors repaired

Spare we can supply most parts from single ICs to complete exchange boards

**Sales(new/secondhand)-Installation-Cabling**

Why not save hassle and send us your computer for repair by post

**Phone 081 979 5638**

**86 Walton Road East Molesey Surrey KT8 ODL**

150 Space public car park at rear of shop

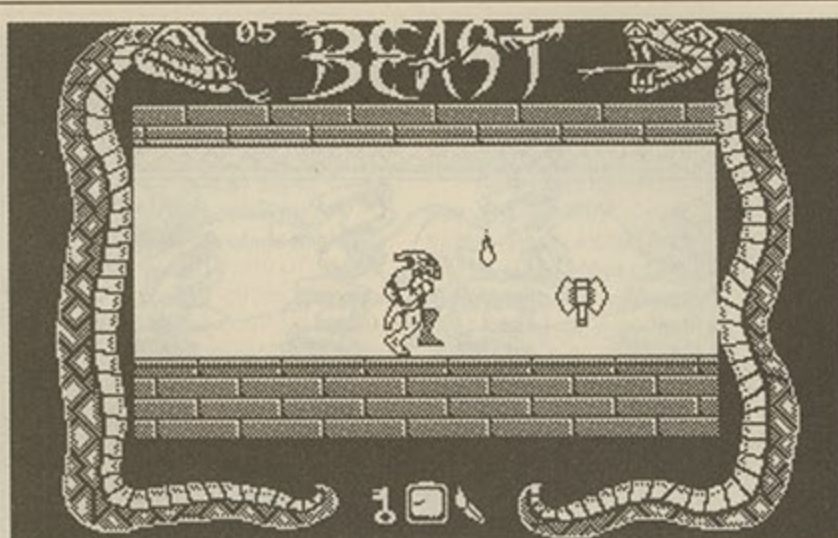

• An unwholsome character featured in Shadow of the Beast

### MOTO CROSS SIM POKE

Andy Price is the man of the moment this week, with this infinite times/lives/bikes etc poke for the Coders' classic two-wheeler. (Now on the Quattra Power Pack compilation.)

- 1 MotoCross Simulator
- 2 ' by ANDY PRICE
- 3 '
  - 10 DATA 2A,38,BD,E5,AC
  - 20 DATA E1,22,2F,BE,AD
  - 30 DATA 21,37,BD,3E,C3
  - 40 DATA 77,23,3E,23,77

- 50 DATA 3E,BE,23,77,21
- 60 DATA 40,00,E3,11,00
- 70 DATA BB,00,C3,4A,3A
- 80 DATA AF,32,C7,05,32
- 90 DATA 2B,0D,00,00,00
- 100 DATA 00,CF
- 110 MEMORY &3000:LOAD"
- 120 FOR y=&BE00 TO &BE2E
- 130 READ pS:p=VAL("&\*+pS)
- 140 ch=ch+p:POKE y,p:NEXT
- 150 IF ch<>&10A8 THEN 170
- 160 CALL &BE00
- 170 PRINT"error in DATA"

Rod Lawton



• A glimpse of a beastly logo

## POST EXPRESS

All prices include VAT & Delivery  
 All computers are genuine UK specification.  
 All computers include a FREE HOLIDAY PACK.  
 Proprietor: Mark A Cameron.

Please make cheques/P.O's etc payable to POST EXPRESS

POST EXPRESS,  
 HILLCREST HOUSE, SUITE 3,  
 49A VICARAGE ROAD,  
 LONDON E10 5EF  
 TEL: 081 518 7494 9am - 11pm

☆ FREE 2 YEAR WARRANTY WITH ALL COMPUTERS BELOW! ☆

### AMIGA 500 SCREEN GEMS PACK ★

Amiga 500.....£399.99	<b>£364</b>	OUR PRICE
Days of Thunder.....£24.95		
Shadow of the Beast.....£24.95		
Back To The Future II.....£24.95		
Knight Breed.....£24.95		
Deluxe Paint II.....£49.95		
AND MORE!		
TOTAL RRP OVER £600.00		

### AMIGA 500 BATMAN PACK ★

Amiga 500.....£399.99	<b>£364</b>	OUR PRICE
Deluxe Paint II.....£49.95		
Interceptor.....£24.95		
The New Zealand Story.....£24.95		
Batman The Movie.....£24.95		
AND MORE!		
TOTAL RRP £524.00		

### AMIGA 500 FLIGHT OF FANTASY ★

Amiga 500.....£399.99	<b>£364</b>	OUR PRICE
Deluxe Paint II.....£49.95		
F29 Retaliator.....£24.95		
Rainbow Islands.....£24.95		
Robot Monsters.....£24.95		
AND MORE!		
TOTAL RRP: £519.79		

### AMIGA 500 CLASS OF THE 90'S PACK ★

Amiga 500.....£399.99	<b>£529</b>	OUR PRICE
Educational s/w.....£660.00		
Upon registration each purchaser will receive a file containing:- Over 200 pages of advice, guidance and worksheets relating to the National Curriculum and lots more!		
TOTAL RRP £1054.48		

### ATARI STFM DISCOVERY PACK ★

ATARI STFM.....£299.99	<b>£264</b>	OUR PRICE
Bomb Jack.....£24.95		
Carrier Command.....£24.95		
Outrun.....£24.95		
Space Harrier.....£24.95		
ST Tour.....£49.95		
Discover the ST.....£14.95		
Control ACC.....£9.95		
Emulator ACC.....£9.95		
First Basic.....£24.95		
Neochrome.....£29.95		
STOS The Games Creator.....£29.95		
AND TONS MORE!		
TOTAL RRP: £569.48		

### ATARI 520 STE SUPER POWER PACK ★

Atari STE.....£399.99	<b>£364</b>	OUR PRICE
ENTERTAINMENT/PRODUCTIVITY S/W		
Afterburner, Buggy Boy, Double Dragon, Gauntlet II, Outrun, Pacmania, Predator, R-Type, Space Harrier, Super Hang-On, Xenon, Black Lamp, Bomb Jack, Bombuzal, Eliminator, Mousetrap, Nebulus, Star Goose, Star Ray, First Basic, Music Maker, Personal Organiser AND PLENTY MORE!		
TOTAL RRP: £1009.94		

### ATARI 1040 STE SUPER POWER PACK ★

Atari 1040 STE.....£499.99	<b>£444</b>	OUR PRICE
Arkanoid II, Ice Palace, Black Lamp, Buggy Boy, Chopper X, Eddie Edwards, Ski, Ikari Warriors, Marble Madness, Quadrallien, Ranarama, Return to Genesis, Road Wars, Seconds Out, Starquake, Olympics, Test Drive, Thrust, Thunder Cats, Wizball, Xenon, Zynaps, Personal Organiser and much more!		
TOTAL RRP £953.97		

### ATARI 1040 STE HOME/BUSINESS PACK ★

Atari 1040 STE.....£499.99	<b>£449</b>	OUR PRICE
Wordprocessor.....£49.95		
Database.....£49.95		
Spreadsheet.....£59.95		
Business Graphics.....£39.95		
First Basic.....£49.99		
S.T.A.C.....£39.95		
Hyper Paint.....£24.99		
Price.....£24.95		
AND PLENTY MORE!		
TOTAL RRP: £839.71		

Please phone or write to us for your free catalogue. There are some terrific bargains to be had:  
**AMIGA 2000 UP TO £500 OFF**  
**ATARI MEGA ST UP TO £300 OFF**  
**STACY UP TO £200 OFF**  
**TEL: 081-518 7494**

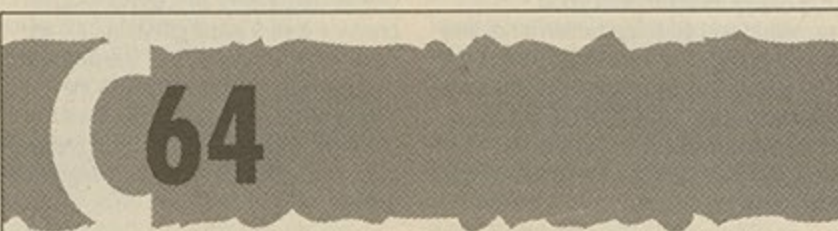

### BATTY GAME

News has been somewhat thin on the ground this week so I've had the chance to take a close look at one of the heavier software releases. Adventurers only, read on...  
 New in from Ubi-Soft and causing much scratching of heads among those who've seen it, is the role playing opus, BAT, in which you play an agent of the catch-all organisation, the Bureau of Astral Troubleshooters. Your mission begins on the planet Selenia, where you must seek out and eliminate Vrangor - a thoroughbred psycho who is threatening to wipe out life as Ubi-Soft knows it.  
 You can play a pre-generated character or design your own individual

character. The design system for these is quite flexible. Certain characteristics are preset for all novice agents (such as level and experience), while others can be customised at your discretion from a points pool. This means that you could design a character who's great at following suspects but not too hot at aiming at targets more than fifty feet away. Or you could create a smooth-talking weapons expert who wouldn't know a clue if it landed on his head and shouted, "Take me to your leader!" It's a balancing act of course and one which will ensure that no two players ever have a similar game.  
 But the game itself is weird. Once your character is up and running it works through a number of screens

depicting various scenes. To start with, the entire screen is taken up by a view of some alien spaceport, with various aliens scuttling around beneath a spaceship of the kind H.R. Giger would be happy to see landing in his garden.

The only device to remind you of the game is the joystick pointer. As this passes over certain areas of the screen it changes shape, indicating that some particular type of action may be pursued there. Over some aliens, for instance, it changes into a speech bubble, indicating conversational possibilities. Over others, it changes in to a profile of a face before an exclamation mark (general encounter). Then it changes into directional arrows when you want to proceed in a given direction. You select the action of your choice by hitting the fire button when the cursor corresponds to the appropriate shape. If you select the fire button at any other time, a number of personal options present themselves, including the option to use your character's wrist-implanted computer.

From here you can do such things as set up a translation unit so you can understand some of the extra-terrestrials around you (you have to select between robots and aliens) or program nuggets of useful code.

Once you make a move from your start location, the screen becomes cropped and the relevant picture, illustrating your new location, is displayed in the remaining space. The cursor only moves in that portion of the screen allocated to displaying your current position. Later, text supplements appear on the screens, making the game look a little more akin to the kind of adventure you have probably come across in the past. But playing *BAT* leaves you in no doubt that what you have here is something entirely different.

Ubi-Soft's game is different to the

traditional adventure in other important respects as well. It's open-ended - allowing a number of solutions to given problems - and a choice of approach to the game generally. The problem with this is that the game lets you wander around in various unproductive directions without any concern for your mission (in which there is a game-time limit) and without the usual clues to point you in the right direction. As a result, *BAT* comes over as something of a curiosity rather than a game. It offers a sophisticated role-playing environment for you to involve yourself in and this is coupled with a highly convoluted plot. But you actually have to go looking for the game. It's not rammed down your throat in the conventional fashion and a certain amount of effort and patience is called for on the part of the player.

The manual, unlike most manuals of this ilk, is actually well worth a sit-down read, rather than the usually ponderous game manual form, which rarely summons forth more than a reluctant skim. That's not to say that it manages to convey much in the way of being able to play the game but it does lay it on thick with the background, and this is nice because it sets the scene, creates the mood etc. Just how much of this wealth of waffle will be of use to players in the long term is impossible to tell but it would appear that the author gets a regular fix of serious science fiction.

To be honest, *BAT* goes heavy on the disk accessing, but don't worry - changing between the two double-sided disks isn't too frequently a problem. It's a slow and confusing game and not ultimately completely satisfying, but certainly the best of its kind for some time. And it's just screaming to be converted to ROM, so I suppose that's going to be something something to look forward to isn't it?

Sean Masterson

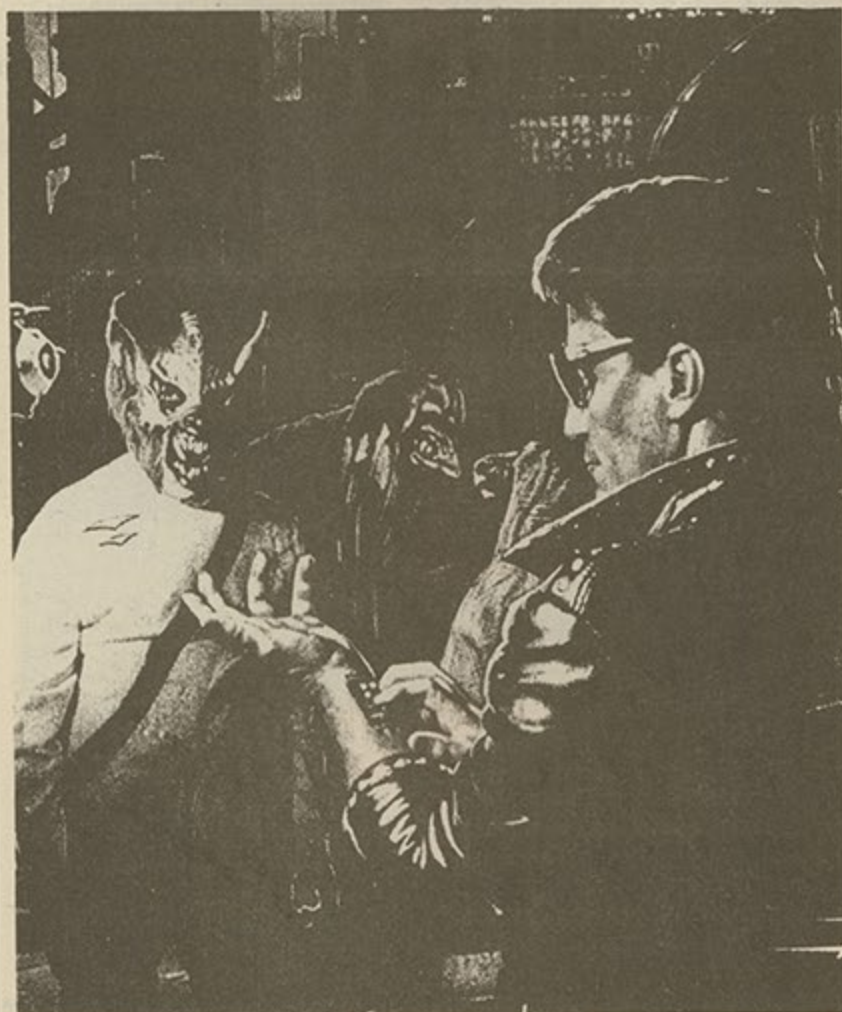

• *BAT*: Get your fix of science fiction.

# YOUR OWN PD/SHAREWARE LIBRARY

## FOR ONLY £29.95

OVER 750 OF THE BEST PD/SHAREWARE PROGRAMS/FILES FOR IBM AND COMPATIBLES

Using the very latest archiving techniques, together with an easy extraction facility, we have compressed what would normally be supplied on 40 or 45 disks on to a 12 disk set.

All the most popular programs are there, including Galaxy, PC-File, As Easy, PC Write, Power-Menu etc.

GRAPHICS, Accounts, Games, Printer Utils, File Utils, Disk Utils, Tutorials, Programming Languages, you name it and it's there.

A program at your finger tips for all occasions.

BECOME a power user.

No extra charge for 3.5" Disks

Please add £2.00 Post & Packing. Cheques or postal orders.

**P C LINDLEY (SOFTWARE),**

101 FRANCIS STREET, CHADDESDEN, DERBY DE2 6DE  
TELEPHONE: (0332) 43721

## E.E.C LTD

★ SPECTRUMS ★ QLs ★ PRINTERS ★

SPECTRUM PLUS 2 £109.95 (AS NEW) SPECTRUM PLUS 3 £149.95

★ MICRODRIVE EXPANSION KIT★	
Includes Microdrive, Interface 1, Booklet, Network Lead, Introduction	
Cartridge and flex connector	£59.95
MICRODRIVE EXPANSION KIT AS ABOVE WITH 2 MICRODRIVES	£69.95
EXTRA MICRODRIVES (New)	£24.95
EXTRA MICRODRIVES (Reconditioned)	£16.95
MICRODRIVE CARTRIDGES	Wallets of 4: - £12.00. Boxes of 20: - £55.00
INTERFACE 1 CONNECTORS AND LEADS	each £3.50
PRINTER (RS232) LEADS FOR INTERFACE 1	£12.95
POWER SUPPLY UNITS 48K (Standard)	£8.95
POWER SUPPLY UNITS for Heavy Duty, or 128K	£10.00
POWER SUPPLY UNITS for Heavy Duty, or 128K +3	£18.00
POWER SUPPLY UNITS for QL	£12.00

### ★ SPECIAL OFFERS ★

Philips 9CM073 Professional colour monitors	
14" High res. RGB.	£220
3.5" Universal (MGT Lifetime) Disk drive cased with PSU, for Spectrum, QL, Atari, Amiga etc.	£89
Lead for D/Drive	£12

### ★ PRINTER CLEARANCE ★

CENTRONICS INTERFACE	(£20 if bought with computer)	£24.00
DAISYWHEEL PRINTER C.I.T.O.H SERIAL TYPE 20cps. Paper Width 13 ins. Chars/line; 115, 138, 172 selectable on top panel. Can proportional print, also make 1+3 copies. Inc lead		£140.00
ALPHACOM PAPER; ONE ROLL	£3.50	FIVE ROLL PACK: £12.95

### ★ SINCLAIR QL ★

THE EXPANDABLE SYSTEM FOR SMALL BUSINESSES, BEGINNERS AND EXPERTS  
**QLs COMPLETE. JM FULLY TESTED AND WITH 6 MONTHS WARRANTY £125**  
 SOFTWARE: QUILL - Word Processor, ABACUS: Spread Sheet, ARCHIVE; Records, EASEL: Business Graphics.  
 CUSTOMERS BUYING ONE OF THE QL COMPUTERS ARE GIVEN ONE YEAR'S FREE MEMBERSHIP TO QUANTA (Help, Newsletters, & 40. + library programs - most Free).  
 QUANTA MEMBERS CAN OBTAIN A £5 DISCOUNT.  
 ★ The JM QL can run all the Programs available for the QL system ★. The JS ROM CAN BE FITTED AND TESTED BY EEC LTD FOR AN EXTRA £25 at the time of order, but not retrospectively.  
**BUSINESS SOFTWARE** (Suitable for Standard QLs) SMALL TRADERS PACK £24.95. INVOICER £19.95. GENERAL LEDGER £19.95. SET OF THREE £50. MAIL MERGER £14.95. FILLER PACK £14.95. Also STOCK ACCOUNTING £39.95, (for expanded QLs)  
 Send S.A.E for DETAILS & QL FULL PRICE LIST.



PRICES INCLUDE VAT. TERMS CWO, ACCESS OR VISA.  
 Minimum order £10. Carriage £8.00 for printers & QL (overseas £20.00).  
 Other items £3.00 (overseas £6.00)



**EEC LTD**

18 - 21 Misbourne House, Chiltern Hill, Chalfont St Peter, Bucks, SL9 9UE. Tel: 0753 888866. Fax: 0753 887149 (AD7)





# CLASSICA COMPUTER SYSTEMS

52 Old Elvet  
Durham City,  
DH1 3HN

## (LOW PROFILE) Mono

XT 10.....	20MB SF .640KB RAM...	£665
286/12.....	20MB SF .... 1MB RAM...	£750
286/12.....	40MB SF .... 1MB RAM...	£895

## (DESKTOP)

286/16.....	40MB + SF .... 1MB RAM...	£915
286/20.....	80MB + SF .... 1MB RAM.	£1165
386 SX/16...	40MB + SF .... 2MB RAM.	£1164
386 SX/16...	80MB + SF .... 2MB RAM.	£1344

## (MINI TOWER)

386 SX/20...	80MB + SF .... 2MB RAM.	£1535
386 SX/20.	100MB + SF .... 2MB RAM.	£1636

## (TOWER) Mono

386/25.....	100MB + SF .... 2MB RAM.	£1875
386/25.....	180MB + SF .... 2MB RAM.	£2102
386/25C...	180MB + SF .... 4MB RAM.	£2443
386/25C...	200MB + SF .... 4MB RAM.	£2556
386/33C...	180MB + SF .... 4MB RAM.	£2682
386/33C...	200MB + SF .... 4MB RAM.	£2795
386/33C...	300MB + SF .... 4MB RAM.	£3364

Full specification on request  
Phone for full range details

ON ALL PRICES SHOWN PLEASE ADD £100  
FOR VGA MONO & £200 FOR VGA COLOUR

All prices exclude V.A.T. and delivery. Delivery will be charged at cost. Prices and specification are subject to change without notice. Despatch of goods will normally be effected within 4 working days of receipt of cleared payment, subject to availability. Goods are not offered on a trial basis and are sold subject to our standard conditions of sale available on request. E. & O. E.

# 091-383 0922

# PC

## LONG LIVE THE PC

The PC will still be around when you're dead and gone - don't listen to anyone who tells you otherwise. Yes, I know people said the same thing about CP/M machines in the 1970s, but that was different. At their height they only had around 1000 commercial applications - many of which, like the machines, were rough and didn't suffer from too much standardisation. By contrast the PC has more than 10,000 commercial packages, with more arriving daily. Moreover, the hardware itself keeps improving - well, at least it gets faster. The platform for that speed is the 386 chip (and the 486 and no doubt, soon, the 586).

What few users are aware of is that only Intel - who designed the 386 - makes it. It won't issue licences to anyone else. So what? So several things. With only one supplier and a PC market totally tied in to the Intel range of chips, as the PC is, Intel can charge what it likes. After all, the customers can't go anywhere else. Since, in chip terms, Intel doesn't make very many 386s - and since IBM gets first call on them anyway, it isn't surprising that 386 chips go for around \$500 each; a price you can buy two entire 386SX motherboards for.

That's one thing. Another is that Intel doesn't make them in very many places - a relatively small earthquake would foul up the whole market. A company called AMD is currently working on a clone of the 386 and expect to exhibit this autumn - if Intel doesn't persuade the American courts to stop it. And we're talking big money for the successful law firm here. If AMD succeeds expect to see 386 machines drop dramatically in price over the

following year. Until then you can just sit and seeth, green with envy of a company that's managed to get a stranglehold on such a lucrative market.

Few home users buy 386 machines - most go into business. Their arrival ensures a slow, but constant rain of lesser PCs descending - like manna - from on high. The amortisation period (which just means how long the accountants allow before writing off the initial cost) for PCs is about two years - pretty standard in the business world. Once paid for they get replaced and passed down the chain. If 386 machines suddenly become the business norm we could see a sudden rush of 12MHz AT machines appearing on the second-hand market and in the auction rooms in the next year or so. These are more likely to be in my price range.

I don't know about you but I'd welcome a second hand AT on my desk at home - it's going to be a long time (like never) before I need multi-tasking, but I wouldn't mind a bit more speed and a bigger address space. Let's all wish AMD every success.

Oddly enough, despite those 10,000 software packages, most PC users are familiar with only three or four at most (claims a recent report, pointing out that Mac owners generally use five or six applications - but they steal them). Personally I think three or four is good, in business you can find many users familiar with nothing but WordPerfect. Totting up my own favourites I get to five items that I can claim to be familiar with - and wouldn't like to be without. All my actual work gets done with just two packages - Protext and Xtree Pro, a word processor and a hard disk manager. For

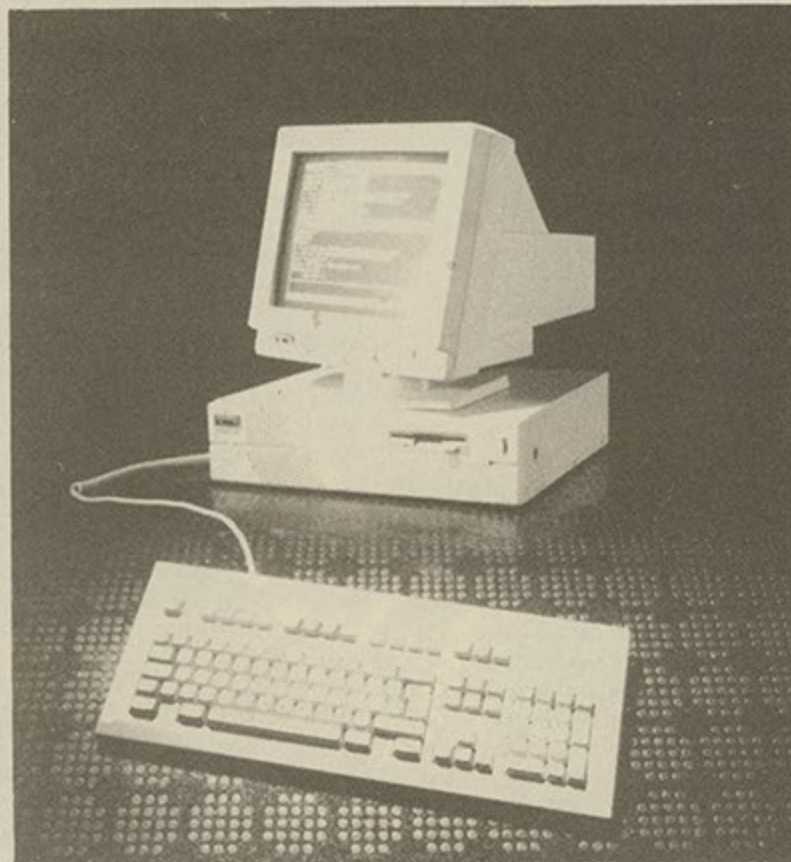

• Whereas you can now pick up a XT for a few hundred pounds, with the consolidation of the 386 as the business norm, we're likely to see masses of 12 MHz AT's appearing on the second-hand market.



DTP stuff I use *Timeworks*. *Zortech C* does for programming and the *Brief* text editor for editing because it's brilliant.

Looking at this list I suddenly realised that all of them run happily on an XT (what do you mean they're mostly cheap too? The phrase you're looking for is 'a high price/performance ratio'). For those who regards a PC as a tool (rather than a sex object) the XT remains adequate for many tasks. In fact I challenge you to state whether a word processor is running on an XT or an AT without reading the label on the front of the system box. The power of programs like these - and their low cost - is the reason that the PC will never die.

**FRACTINT**

When *Express* asked me to stand in for Stuart for a week they said 'don't just rant, talk about some products'; oh all right. The very best program I've seen recently won't cost you a bent Pfennig. It's also the first good argument I've ever seen for a home PC user to invest in VGA colour graphics (I like the Hercules display for writing, actually). It calculates and displays Mandelbrot images, Julia sets and sundry other clever, chaotic images. It does it fantastically fast (ten times faster than one of my own programs). You can

zoom in on the image interactively. It will map the resulting images on to spheres, give 3D renderings of them or cycle through the colour palette - which makes the images appear to come alive. The program is called *Fractint*. It's in the public domain. You can get it from the PDSL (tel 0892 663298). Oh yes, and it runs on just about every other graphic adaptor too.

At very nearly the other end of the scale in terms of cost - but still in graphics mode - is *Picture Publisher*. This is professional quality monochrome picture editing software. In the bad old days men and women with airbrushes had to take the spots off models for the big spreads in *Vogue*. Now you just scan the photograph into your PC and edit it electronically. Not only is *Picture Publisher* incredibly powerful, it's great fun to use. With it you can, for example, place *Vita Sackville-West* in bed with the character of your choice - undetectably. Who says the camera can't lie? Not only can't you believe everything you hear, but from now on you'd better check out what you see as well. *Picture Publisher* is available from Ctrl-Alt-Deli on 0908 662759. It needs VGA, Windows 3, a flatbed scanner and a photo-typesetter for best results.

Steve Patient

# Spectrum

**MUSIC**

The Specky's often thought to be a bit lacking in musical ability but that's never stopped any of Stock, Aitken and Waterperson's evil disciples and I'm glad to report another music-making utility has just arrived. This of course is only a few months after the thoroughly splendid *Music Writer* package was released to much tossing of hats in the air and loud hurahing.

*Childs Play* is a composition program for the Plus-3 only (although a tape version is apparently due for release soon) that allows you to write masterpieces on-screen and then replay them through a Midi system or television.

The process of writing tunes is pretty straight-forward, even for someone like me who used to mess around in music lessons at school. First of all you select the note of your choice from the main menu using a cursor system and then the display switches to the music screen. Here you use the cursors to place the note on the staff. You're able to string notes together to create double notes, there's an option to repeat sections of your piece and both dotted notes and triplates, whatever they are, can be selected. I don't know, but apparently these are good things to have in a musical utility.

If you're rich enough to own Midi instruments, *Childs Play* lets you play your ditties in four separate note voices, but humble commoners who have to make do with a TV only get three voices. The whole thing's been written in BASIC, although it doesn't really seem like it, so you can fiddle about with a back-up copy to let you get

the most out of any hideously expensive and trendy Midi equipment you want to use in conjunction with the program.

On the flipside of the disk is a loader routine that lets you replay any compositions you've saved to disk for posterity. Two demo pieces have also been thoughtfully included for your listening pleasure.

Even someone as musically ignorant as I found *Childs Play* pretty easy to use, despite the fact that the manual's a bit on the weedy side. It's not as professional looking, or contain the wealth of complicated musos' features that *Music Writer* had, but nevertheless it's a fair deal cheaper at £8 for the Plus-3 disk version, or £6 for a Plus-2 copy on tape. Midi owners seem to be better served with this program too, although I'd ask someone who knows a little bit more about musical things than I do before splashing out for it. *Childs Play* is available from P Naughton, 2 The Gills, Otley LS21 2AH.

Oh yes and I've been told that members of the Plus-3 Users' Group will apparently be able get an entire £1 discount when ordering it; aren't they lucky things eh?

**RETURN OF THE FANZINE**

I thought *Spectrum* fanzines were a dying breed, but there seems to have been a sharp increase in the number rolling off the photocopier and tape deck of late.

One regular electronic mag I always slap straight in my Plus-3 without a moments hesitation is *Outlet*. This on-screen mag has been going for three years and the latest issue I've

## What you see is what you pay - no hidden charges!

All prices include postage, VAT and labels

### Top Quality 3.5" DSDD each

1-49 46p      50-99 44p

100-149 43p      150+ 42p

40 disks & 40 capacity box £22.00

80 disks & 80 capacity box £41.00

### Disk Boxes

3.5" (80 capacity) 1 £7.40    2 £12.78

Other sizes available - telephone for prices

All disks are purchased direct from a major manufacturer and are 100% guaranteed.



MARKETACE LTD



20 Stapledon Road, Orton Southgate,  
Peterborough PE2 0TD

Tel: (0733) 371799 (24 hours)

Fax: (0733) 370722

Callers welcome Mon-Fri 9-5. Sat. 10-1.

## MORE AMAZING OFFERS FROM BCS LTD

3 1/2" DS/DD  
3 1/2"

50 Disks + 80 Box .....£25  
100 Disks + 80 Box .....£41  
150 Disks + 80 Box .....£58  
200 Disks .....£72  
400 Disks .....£132  
500 Disks .....£Call  
Price includes VAT & P&P

Inc. Labels

Amiga 1.5 Meg Upgrade £100

3 1/2" POSSO STACKABLE BOXES £15.00

3 1/2" 40 cap boxes £4.00  
280 cap boxes £4.30

5 1/4 DS/DD 23p  
5 1/4 DS/HD 47p

SONY BRANDED 75p

100 3 1/2 DS/DD £37 Inc. P&P & Vat

SONY BULK 43p

3 1/2 DS/HD 80p

★ ALL DISKS CERTIFIED 100% ERROR FREE ★

ALL PRICES INCLUDE VAT. ADD £3 P&P. ADD £9 NEXT DAY

<b>AMIGAS</b>	Mouse Mat.....£2.50	<b>ATARIS</b>
SCREEN GEMS.....£355	Cleaning Kit.....£2	DISCOVERY...£259
BATPACK.....£355	Ram Pack.....£35	Turbo Pack....£350
FLIGHT OF FANTASY.....£355	+ clock.....£40	EXTERNAL DRIVE +PSU.....£67
CLASS OF 90'S.....£493	Cumana drive...£66	Zip Stick.....£11
FIRST STEPS.....£510	35" ext drive.....£57	

★ QUICKJOY JET FIGHTER JOYSTICK £12 ★

CALL OR SEND CHEQUES TO B.C.S LTD  
349 DITCHLING ROAD, BRIGHTON BN1 6JJ  
Tel: 0273 506269 (mobile phone: 0831 279084) 7 days. 24 hours.



# NEWS FLASH

**Full Circle Technologies (UK)**  
are proud to announce:

## The Logitech Mouse

*The mouse that won the IF Award (The International Federation of Design Consultants) and comes with a two year guarantee. Costs only £29.50*

*Once you have tried the Logitech Mouse you'll never be satisfied with the standard one again. No wonder it is being called the Rolls Royce mouse for the Atari ST.*

Official distributors  
Full Circle Technologies (UK)  
133a Parrock Street  
Gravesend  
Kent  
DA12 1EZ  
Telephone 0622 677173  
Fax 0474 533280

seen, number 37, is another corking good collection of stuff to read and programs to load from a single key press menu. The contents are as mixed as ever, with loads of letters, some utility reviews and a great variety of programs, ranging from *Pop Art*, a messy pattern drawing demo, to a version of *Forth*, to an excellent but simple puzzle game set in ancient Greece.

An introductory copy of *Outlet* is heartedly recommended and costs £2.50 on tape, Plus-D, Opus, Microdrive and Plus-3 disk, as well as SAM. Tape and disk from Chevron Software, 605 Loughborough Rd, Birstall, Leicester LE4 4NJ.

*Re-Run* is another fanzine I've seen recently, although unfortunately it's not Spectrum-specific but instead covers 8-bit machines ranging from the Atari to the BBC. Naturally the Spectrum gets the biggest slice of the fanzines' scrappy looking 20-odd pages with a few reviews, an adventure section and tips but best of all is the half-page devoted to the amazing but sadly long since deceased ZX-81. *Re-Run* also has a few pieces of public domain software on offer, including a Z80 Assembler and an adventure called *Noah*. Send an SAE for details to *Re-run*, 1 Northolme Close, Grays, Essex RM16 2NX.

### SAM

I've just received a really nice, ego-boosting letter from Phil Glover in Birmingham.

He says he was sorry to see the SAM column disappearing, but reckons things are looking a bit brighter for our blue-footed chum - "I must admit I've been very concerned over the last few months with the bad news about MGT and the awful ROM difficulties, but in the last couple of weeks things have really started to look up. All we need is for SAM to get back into production!" he says, hopefully adding "Perhaps Express might re-instate your column."

I'll drink to that, but in the meantime, if you really want to keep up to date with all the exciting new SAM Coupé developments and the like, there's always *Your Sinclair's 'SAM Surgeon'* page. Speaking personally and in my humble opinion, I always find this to be a feast of witty writing, packed to bursting point with info and tips. However much they're paying the writer of the above, it isn't nearly enough. Thanks a bunch to Phil for writing. If anybody else has views on the subject, don't keep them to yourself but write to me at you-know-where.

### TIP

Here's a small tip for Plus-3ers. You know of course that you can type your Spectrum in Plus-3 BASIC to go into 48K mode. But the trouble, is according to the manual provided, you can't reverse the process. Chris Roberts of Norwich knows better though. Type `RANDOMIZE USR 23354` and [Enter] to switch back to Plus-3 BASIC. Anyway, see you next week.

Robin Alway

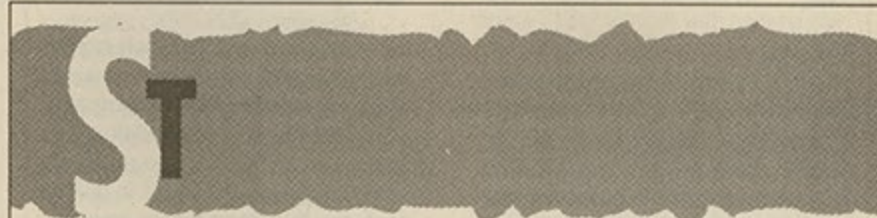

### MONO MONSTER

German company Data Becker has launched yet another monochrome graphics program into what is rapidly becoming the most cluttered area of the ST market.

*Leonardo ST*, which works in vector mode only, offers up to 250 drawing levels, a mightily useful multiple Undo option for those embarrassing cock ups, produces GEM metafiles and Postscript and supports most printers.

The most attractive thing about this package is remarkably modest price of £40 from Data Becker. Call 010 49 211 31001 and be prepared to explain that your German isn't up to much - unless, of course, it is.

### PHILIPS CHOP MONITOR

The 'world's best-selling monitor' (according to Philips) is dead.

The snappily monikered CM8833 is said by its manufacturer to have sold an astonishing 4,000,000 units in its four year life. So, like the acute marketing machine it is, Philips has now chopped it off at the mains lead.

Well, sort of. Make way, if you would, for the Mark II, a redesigned and upgraded model. Its chief boast is that it meets stringent new safety standards expected to be introduced throughout the European market (cue hisses from that old xenophobe Nick Ridley).

For those among you whose garment of preference is of the warm waterproof hip-length with a hood variety, this particular 14 inch boasts TTL-digital and RGB-analog computer input signals; CVBS input for video signals; stereo sound and an earphone socket.

This little lot will set you back £300 - and since prices differ enormously it's definitely worth shopping around (as it always is for hardware items).

### POOLS WINNER CORNER

Most of us dream of one day expanding our ST memory up to the current supported limit of 4Mb. Not those notoriously power-hungry Germans (that's quite enough for one week from you, Ridley), who have come up with a board with a complete new MMU that offers you not 4Mb nor even 8, but a whacking great 12Mb.

There's a price to pay for this size of memory, of course - a price not entirely un-adjacent to an eye-watering £1,400, in fact. Pools winners only need apply to H. Richter, Distributor, Hagener Str 65, D-5820 Gevelsberg.

### ANOTHER POOLS WINNER

Working on a hard drive round up for *ST Format's* November issue - out on Thursday - I decided to see what was the hunkiest, chunkiest model currently

available. What do you think? 100Mb? 200Mb? Nah. Chickenfeed. How's about a 600Mb drive that works at the speed of light? Now that's what I call a hard drive.

It reads and writes to a floppy disk, but not as we know it, Jim, for this floppy is a 5.25-inch optical disk that costs about £250 a go and stores an amazing 60Mb. Call Power Computing on 0234 273000. It costs £3,000.

**PEEK INTO THE FUTURE**

Regular readers may have noticed that I don't rattle on and on about the glorious TT, Atari's £2,000-plus superfast ST-compatible 68030-based monster. The reason is just that very price, far out of the range of myself and most of your good selves, coupled with the fact that I haven't yet seen one for sale in this country and that Atari has been 'launching' it for about two years.

But I make an exception this week, because the version of TOS (The Operating System) that comes with it is, without doubt, a glimpse into the Desktop the ST will have within months (er, but I'm not specifying how many months, note!).

It's really quite an advance on the current version that you see when you boot-up. You can change screen resolutions without having to reboot, and you can drag files and folders onto the Desktop, so stuff you're likely to want is where you can find it.

Icons can be of any design, and any program, and every option that you usually have to activate from those bloody awful pull-down menus, can be selected from the keyboard. These improvements are exactly the kind of things people have been urging for years.

It does indeed look, as several catty types have observed, as if Atari has taken a peek at the Macintosh desktop, which is enough to make anyone who has to work with the Atari version - yours truly included - physically sick with jealousy.

**THE POWER OF THE PEN**

Active's rather spiffing *Dragonflight* was very well received in *ST Format* last month - apart, that is, from one thing. £34.99 is really too much, said the magazine.

'Fair enough', said Active. And promptly dropped the price by a fiver. Such is the power of the pen.

**PD FROM HELL...**

If you've never sampled the delights of ST Public Domain - ie copyright free - software you should do so forthwith. It's by far the best way to get a taste of the kind of things you can do with your ST. One of the best is Paradise Computers PDL, 9 Westfield Crescent, Brighton BN1 8JB. Paradise charges £1.95 per disk, plus a postage charge of 50p.

Steve Carey

**HIGH QUALITY DISKETTES**

PIN NUMBERED QUALITY DISKETTES 100% CERTIFIED AND GUARANTEED 100% ERROR FREE. MANUFACTURED AND QUALITY ASSURED BY AN INTERNATIONAL BRAND NAME

**3 1/2 DS 720K**  
**37p**  
 EA

**3 1/2 DD**

**3 1/2 DS 40P**

**5 1/4 DS**  
**21p**  
 EA

**5 1/4 DD**  
 360 K

**DSHD 1.44MB**

**5 1/4 HD 1.2 MB**

**3 1/2 42p**  
 EA

**85p EA**

**EA STORAGE BOXES**

**3 1/2 PLASTIC LIBRARY 89p**

**5 1/4 CASES**

3 1/2 40 cap ...£4.20    3 1/2 80 cap.. £4.60  
 5 1/4 50 cap ...£4.40    5 1/4 100 cap £4.90

**EURODATA**  
 12A QUAKERS YARD  
 ADAM AND EVE ST  
 MARKET  
 HARBOROUGH  
 LEIC LE16 7LT  
 TEL: 0858 433992  
 FAX: 0858 432549

**LIFETIME GUARANTEE**  
**ALL PRICES INCLUDE DISKETTE LABELS ENVELOPES AND VAT**  
 ORDER NOW WITH POSTAL ORDER OR CHEQUE MADE PAYABLE TO EURODATA, OR TELEPHONE YOUR ORDER USING MASTERCARD & VISA. SUBJECT TO AVAILABILITY  
 ADD £3.20 P&P

GO ON  
 BE  
 TEMPTED



**Macintosh**

**NEW MACS**

Last week, I talked about the Mac Classic, which is undoubtedly going to be the most popular of Apple's new Macintoshes. But there are two other new arrivals - the LC and the IIsi - which are certainly worth consideration.

The LC is Apple's lowest-cost colour computer, and at £1,495 for the LC and a 12-inch, 256-colour monitor, represents great value. It's twice as fast as the Classic and the SE, and runs a 68020 chip. If you've got the money, go for this one. The only problem? It won't be on sale until January next year.

The IIsi becomes the cheapest member of the Mac II family. Running a 68030 at 20MHz - which means that it will be able to handle virtual memory when (if!) System 7 finally arrives - it should be up to five times faster than the Classic. The extra power of the 68030 and the fact that it accepts NuBus cards (the standard for Mac add-ons) means that the IIsi will be the choice of many companies.

**BARGAIN CITY**

If you can't afford a Classic, or you want a machine that's slightly faster but can't afford the LC, then don't despair. The second-hand value of older machines has plummeted. People who hoped to sell an SE 2/40 for around £1,600 are accepting that they'll need to knock about £700 off that price to be able to get rid of it. So for the same price as a Classic 2/40, you could pick up an SE - which is faster, and has stood the test

of time as a reliable model, although it may be out of guarantee. For those who really want a cheap bargain, look out for second hand Mac Pluses. These will start to sell on the second hand market for silly prices - with the base-level Classic costing £575, the owner of an unexpanded Plus can't expect to get more than about £200-£300.

**SAVE THAT SCREEN**

I mentioned screen 'burn-in' above; the Mac is more susceptible to it than most computers because some of the items on the screen - like the menu bar, the disk icon and the wastebasket - are always present, and seldom move. There are two things you can do to counter burn-in: the first, cheapest and most obvious is to keep the brightness of your screen fairly low, and not to leave your Mac switched on all the time. The second is to buy a screen saver - a utility which blanks your screen and then puts up a moving image when you haven't used the computer for a certain amount of time.

While there are free and shareware screen savers available, the two best cost money (of course). There is a battle for screen-saving supremacy going on at the moment between *Pyro!* (Riva Ltd, 0420 22666) and *After Dark* (from Softline Distribution, 081 642 4242), with *After Dark* being my favourite because of its on-screen diversions. It's fun and useful and sells for only £30.

Ian Wrigley

**MADE IN THE U.S.A**

"FORMAT ON A HIGH QUALITY PRODUCT AT THE BEST PRICE"

**3 1/2" DS/DD**

**35p/inc VAT**

**100% CERTIFIED**

PRICES PER DISK	DS/DD	DS/HD
10 - each.....	55p	99p
50 - 200 .....	49p	86p
250 - 400 .....	39p	79p
450 - 1000 .....	35p	73p

UNBRANDED BULK, SONY, JVC OR 3M PACKED 10 OR 50 pcs EA

**5.25" FROM**

**DS/DD 25p each                      DS/HD 55p each**  
 INTERNATIONAL BRANDS PKG 10+

COMPLETE LINE OF ACCESSORIES AVAILABLE AT DISCOUNT PRICES.

Add £2.80 for P&P - All prices include VAT/labels. To order send cheque/P.O/ or call



**PHONE: 081 759 8829**  
**FAX: 081 897 0407**

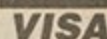

**US COMPUTER SUPPLIES**  
**Room 130/G, Building 521, Cargo Centre, London Heathrow TW6 3LL**

PRODUCTS/PRICES SUBJECT TO CHANGE WITHOUT NOTICE

# AMIGA DEALS

## AMIGA 500 STANDARD PACK

- ★ A500 computer ★ 512k RAM ★ 1Mb disk drive ★
- ★ mouse ★ modulator ★
- ★ power supply ★ operation-manuals ★
- ★ workbench disks, etc. ★



ONLY **£339.95**

### BATMAN PLUS PACK

- ★ Amiga as in standard pack
- ★ Batman the Movie
- ★ F18 Interceptor
- ★ New Zealand Story
- ★ Deluxe Paint 2
- ★ Megablaster joystick
- ★ Dust cover
- ★ High quality mouse mat
- ★ Wicked ten game pack Inc. Invaders, Pacman, Bouncer.

ALL THIS FOR JUST **£369.95**

### FLIGHT OF FANTASY PLUS PACK

- ★ Amiga as in standard pack
- ★ F29 Retaliator
- ★ Rainbow Islands
- ★ Escape from Planet of Robot Monster
- ★ Deluxe Paint II
- ★ Megablaster joystick
- ★ Dust cover
- ★ High quality mouse mat
- ★ Wicked ten game pack Inc. Invaders, Pacman, Bouncer.

ALL THIS FOR JUST **£369.95**

### SCREEN "GEMS" PLUS PACK

- ★ Amiga as in standard pack
- ★ Days of Thunder
- ★ Shadow of the Beast II
- ★ Back to the Future Part II
- ★ Knightbreed
- ★ Deluxe Paint II **NEW!**
- ★ Megablaster joystick
- ★ Dust cover
- ★ High quality mouse mat
- ★ Wicked ten game pack Inc. Invaders, Pacman, Bouncer.

ALL THIS FOR JUST **£369.95**

## THE ALL NEW... ULTIMATE GAMES PACK

Choose any of the above three packs and add the following:

**EXCLUSIVE** Dowling Mega Ten Game Pack comprising: RVF Honda, Datastorm, Dungeon Quest, E-Storm, Grand Monster Slam, Kid Gloves, Powerplay, Shufflepuck Cafe, Microprose Soccer, Tower of Babel.

**PLUS** The Classic Tenstar Pack comprising: Ikari Warriors, Buggy Boy, Wizball, Terrorpods, Barbarian, Thundercats, Art of Chess, Amegas, Insanity Flight, Mercenary.

TOTAL RRP OVER **£450**

ALL THIS FOR THE UNBEATABLE PRICE OF: **£399.95**

**COMMODORE 1084S OR PHILIPS 8833** ★ Stereo colour monitor  
★ Can be used as T.V. with tuner  
★ Includes cables **£249.95**

**A590 HARD DRIVE** ★ Official Commodore hard drive  
★ Sockets for 2Mb RAM  
★ Complete with free software pack  
★ Built-in P.S.U./cooling fan **£269.95**

**PHILIPS T.V. TUNER** ★ Converts your 1084S/8833 into a colour T.V.  
★ Complete with aerial and plug  
★ Free 1 years on-site maintenance **£69.95**

**AMIGA/ST MOUSE** ★ Replacement mouse by contriver  
★ Free mousemat RRP **£34.95**  
★ Free mousehouse  
★ Full 1 year guarantee OUR PRICE **£19.95**

### AMIGA 1/2 MEG UPGRADE BOARD

- ★ Uses latest 4 chip design
- ★ Memory on/off switch
- ★ Option of battery backed clock
- ★ Full 12 month guarantee
- ★ New super low price

**£29.95**  
Clock Version  
**£34.95**

### 3 1/2" HIGH QUALITY DISKS

- Box of 50 ..... **£19.95**
- Box of 100..... **£37.95**
- Roll of 1000 labels ..... **£5.99**
- ★ 100% certified ★ Individually wrapped
- ★ "Made in Japan" media ★ Fully guaranteed

### CUMANA CAX 354 DISK DRIVE

- ★ Latest slimline design
- ★ Quiet, high precision head positioning
- ★ High speed access
- ★ Acknowledged as "the best" (ST Version £69.95)

RRP **£89.95**  
**£64.95**

### NEW COMMODORE 64 NIGHTMOVES/MINDBENDERS PACK

Comprises:

- ★ The worlds best selling home computer - the Commodore 64
- ★ C2N cassette unit ★ 2 joysticks PLUS:- Nightmoves games
- ★ Nightbreed ★ Shadow Warriors ★ Midnight Resistance
- ★ Secret Agent Sly Spy ★ Mindbenders games ★ Trivial Pursuits
- ★ Snare ★ Confuzion ★ Split Personalities

ALL FOR JUST **£149.95**

Plus FREE exclusive to Dowling "Music Studio Software Pack"

Whilst stocks last!

### NEW MUSIC-X JUNIOR

"provides everything that the average amateur musician could possibly require" Amiga Format N.B. Fully compatible with Music X RRP **£79.95** OUR PRICE **£49.95**

### MUSIC-X

Enhanced 1.1 Version

Widely acknowledged as the best music package available. Now with even more enhancements it cannot be beaten N.B. Be wary of older versions being sold cheaper

RRP **£149.95** OUR PRICE **£89.95**

### MIDI INTERFACE

Our own beautifully designed product, colour co-ordinated and designed to sit on your Amiga. Features: 1 x in, 1 x thru, 2 x out. Comes complete with midi lead (extras: £2.99)

RRP **£29.95** OUR PRICE **£19.95**

### THE NEW 200 SERIES FROM stair "The best printers just got better!"

**LC200 FACT FILE** RRP **£297.85**  
★ Multi-purpose 9-pin, 80 column dot matrix printer with colour  
★ Black and colour ribbons included as standard  
★ Electronic dip switches (see LC24-200)  
★ 180 cps draft elite/45 cps Near Letter Quality  
★ High speed draft facility 225 cps at 12 cpi  
★ Swivel selectable push or pull tractor  
★ Bottom feed  
★ Advanced paper parking with sheet feeder installed  
★ Eight resident NLQ fonts: Courier, Sanserif, Orator, Script and italic versions

OUR PRICE **£199.95**

**LC24-200 FACT FILE** RRP **£366.85**  
★ Versatile 24-pin 80 column dot matrix printer  
★ 200 cps in draft elite/67 cps in Letter Quality mode  
★ 10 Resident LQ fonts  
★ A high speed draft facility of 222 cps at 10 cpi  
★ Swivel selectable push or pull tractor  
★ Bottom feed  
★ Advanced paper parking with sheet feeder installed  
★ The economy of first and last line printing  
★ 7 K-byte buffer expandable to 39 K-bytes  
★ 11.7" carriage (A4 in landscape format)  
★ Multi-part mode for 1 + 4 copies

OUR PRICE **£239.95**

**LC24-200 COLOUR FACT FILE** RRP **£424.35**  
★ Multi-purpose colour version of the 24-pin LC24-200  
★ Seven colour printing - black, purple, orange, green, pink, blue and yellow  
★ 30 K-byte buffer expandable to 62 K-bytes  
★ 10 resident Letter Quality fonts: Sanserif, Times Roman, Courier, Prestige, Script and Italic versions  
★ Electronic dip switches operable from the push button front control panel (as the LC24-200 mon version)  
★ Optional font cards including Russian  
★ Standard black ribbons available for economy purposes

OUR PRICE **£279.95**

# COMPUTERS

UNITS 48-50 TYNE ROAD, SANDY, BEDS, SG19 1SA

DOWLING



## PRINTERS

All of our printers come with a free cable and have a full 1 year warranty.

Star LC10 Mono (9-pin)	£150.00
Star LC10 Colour (9-pin)	£195.00
Star LC200 (9-pin) *NEW*	£230.00
Star LC24200 (24-pin) *NEW*	£275.00
Panasonic KXP1124 (24-pin)	£249.00
Panasonic KXP1624 15" carriage (24-pin)	£399.00
Citizen Swift 24 (24-pin)	£299.00
Swift 24 Colour Kit	£34.95

## PRINTER RIBBONS

All of printer ribbons are genuine manufacturer ribbons - we do not sell inferior copies!

1 x LC10 Black Ribbon	£3.50
5 x LC10 Black Ribbons	£16.95
10 x LC10 Black Ribbons	£32.95
1 x LC10 Colour Ribbon	£5.20
5 x LC10 Colour Ribbons	£24.95
10 x LC10 Colour Ribbons	£47.95

Swift 24 Black Ribbons (each)	£3.95
Swift 24 Colour Ribbons (each)	£13.95

1 x Panasonic KXP1124 Ribbon	£8.95
5 x Panasonic KXP1124 Ribbons	£39.99
10 x Panasonic KXP1124 Ribbons	£69.99

## ATARI LYNX

Lynx Games Machine (with free California Games)	£149.00
Game Cards:	
Blue Lightning	£19.99
Chips Challenge	£19.99
Electrocop	£19.99
Gates of Zendocon	£19.99
Gauntlet III	£23.50

RING NOW FOR NEW GAMES!

## IBM PC COMPUTERS

AMSTRAD PC + LAPTOPS, COMMODORE PC, ATARI PC, GOLDSTAR PC etc etc  
PHONE NOW - WE HAVE AMAZING PRICES!

**REMEMBER**  
**ALL OF OUR PRICES**  
**INCLUDE DELIVERY**  
**AND VAT - WE**  
**DON'T HAVE**  
**HIDDEN PRICES**  
**LIKE CERTAIN**  
**OTHER MAIL ORDER**  
**COMPANIES ...**

## MICE

Contriver - ST compatible	£18.95
Contriver - Amiga compatible	£19.95
Contriver - PC compatible	£23.50
Contiver Trackball ST	£29.95
Naksha - ST/Amiga/Amstrad PC	£34.99
1352 - Amiga/Commodore PC	£34.49

## ATARI PORTFOLIO

Portfolio Pocket PC	£179.95
Parallel Interface + cable	£39.95
32K Memory card	£46.75
64K Memory card	£82.95
128K Memory card	£119.00
Finance Card software	£47.50
PC Application software	£47.50
Utilities Card software	£47.50
Serial RS-232 Interface	£56.95
Super Memory Expander	£164.95
Portfolio Card Drive	£67.50
Mains Power Adaptor	£11.99

## PHILIPS 8833 COLOUR MONITOR

All of our Philips 8833 colour monitors come with 12 months on-site warranty and are supplied with a cable of your choice:

8833 + STFM cable	£249.00
8833 + STE cable	£249.00
8833 + Amiga cable	£249.00

## ATARI ST ACCESSORIES

SM124 Mono Monitor	£99.99
Megafile 30 Hard Disk	£449.95
Megafile 60 Hard Disk	£619.95
SLM804 Laser Printer	£1115.00
SLM804 Toner Cartridge	£37.50
SLM804 Replacement Drum	£159.99
Cumana 1 MB External Drive	£89.95
Roctec 1 MB External Drive	£75.00
Forget-Me-Clock II Card	£24.95
ST Monitor Switch Box	£14.95
STE Stereo scart lead	£12.99
STFM standard scart lead	£7.95
Replacement STFM/E PSU	£99.95
Vidi ST Video Digitiser	£86.99
Atari CX40 Joystick	£4.95
Joystick/Mouse extension lead	£4.75
Replacement Mouse lead	£3.75
Standard Parallel Lead	£5.95
14 Pin Din Plug (ST disk drive)	£2.25
14 Pin Din Socket (ST disk drive)	£2.95
13 Pin Din Plug (ST monitor)	£1.95

## AMIGA A500 ACCESSORIES

512K Ram Upgrade with clock	£39.95
A590 20Mb Hard Disk drive	£369.95
Cumana external disk drive	£75.00
Roctec external disk drive	£73.00
Vidi Amiga video digitiser	£99.99
Amiga Stereo Scart Lead	£9.99
Mouse Mat	£3.50

## AMIGA / ST SOFTWARE

Power Pack software (ST)	£34.99
Hyper Pack software (ST)	£14.95
Discovery Pack software (ST)	£19.95
Timeworks DTP (ST)	£69.99
First Word Plus (ST)	£56.99
Turbo Pack Software (ST)	£34.99
Photon Paint version 1 (Amiga)	£9.95
Photon Paint version 2 (Amiga)	£39.95
Deluxe Paint version 3 (Amiga)	£59.95
AMIGA PACK 1: F29/R.Bow Island/ Robot Monst/DPaint 2	£19.95

# BLANK DISKS

All of our blank disks are guaranteed and supplied with labels. Our 3.5" Unbranded disks are either KAO or Sony. All Sony Branded disks are boxed and supplied with labels (all Sony 5.25" disks are supplied with write protect tabs). All disk prices include vat and delivery.

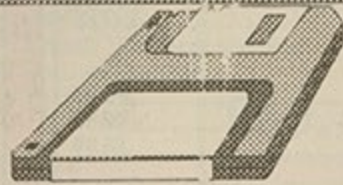

QUANTITY	10	20	30	50	100	200	250	300
UNBRANDED 3.5" DS/DD	5.99	10.99	15.99	25.99	49.00	84.99	99.00	119.99
SONY BRANDED 3.5" 2DD	9.50	18.50	26.50	42.00	80.00	175.00	210.00	245.00
UNBRANDED 3.5" HD	14.95	27.95	39.95	59.99	115.00	225.00	279.95	330.00
SONY BRANDED 3.5" HDD	27.50	53.00	77.00	120.00	235.00	460.00	575.00	680.00
UNBRANDED 5.25" 360K	3.25	6.25	9.25	14.95	27.50	52.50	61.00	77.50
SONY BRANDED 5.25" 2D	7.95	15.50	22.50	36.99	69.99	135.00	165.00	189.99
SONY BRANDED 5.25" HDD	12.99	24.99	34.99	56.99	99.99	195.00	235.00	275.00

# ST MIDI

C-Lab Creator SL V3.0  
C-Lab Notator SL V3.0  
C-Lab Alpha Notator  
C-Lab Unitor  
C-Lab Export  
Steinberg Cubase V1  
Steinberg Cubase V1.5  
Steinberg Voice Editors  
Dr T Tiger Cub

other packages available.

CALL NOW FOR PRICES!

RING TODAY -  
LATEST  
VERSIONS IN  
STOCK AT  
AMAZING  
PRICES!

BEST PRICES (Dept NCE), Unit A,  
Grafton Place, Worthing, West

Sussex. BN11 1QX  
Tel: (0903) 700714

SEE OPPOSITE PAGE FOR MORE DETAILS

TELESALES - 10 am till 12 midnight  
ANSWERPHONE - 12 midnight till 10 am

# ATARI STE

Best Prices are now offering 3 different STE packs:

## THE STANDARD STE PACK

consists of 6 software titles (First Basic, Music Maker, Organiser, Hyper Paint, Hyper Draw and Borodino)

<b>520STE 512K RAM</b>	<b>£329.00</b>
<b>520STE 1MB RAM</b>	<b>£359.00</b>
<b>520STE 2MB RAM</b>	<b>£439.00</b>
<b>520STE 4MB RAM</b>	<b>£549.00</b>

## THE ATARI STE POWER PACK

Consists of 20 software titles (as the 520STFM Power Pack opposite) and a joystick

<b>520STE 512K POWER</b>	<b>£359.00</b>
<b>520STE 1MB POWER</b>	<b>£379.00</b>
<b>520STE 2MB POWER</b>	<b>£469.00</b>
<b>520STE 4MB POWER</b>	<b>£569.00</b>

## THE ATARI STE TURBO PACK

Consists of STOS Games Creator, First Basic, Hyper Paint 2 and Music Maker 2 and 8 games (Indiana Jones & the Last Crusade, Impossible Mission 2, Human Killing Machine, Super Cycle, Outrun, Dragons Breath, Anarchy and Blood Money) and a joystick.

<b>520STE 512K TURBO</b>	<b>£375.00</b>
<b>520STE 1MB TURBO</b>	<b>£399.00</b>
<b>520STE 2MB TURBO</b>	<b>£479.00</b>
<b>520STE 4MB TURBO</b>	<b>£579.00</b>

All STE computers are checked prior to despatch and all prices include VAT and delivery by courier. PLEASE RING FOR CURRENT PRICES AS THEY DO SOMETIMES CHANGE !!!

# STE RAM KITS

<b>DIY 1 KIT - 520STE to 1MB</b> ( 2 x 256K cards ) SIMMS or SIPPS	<b>£39.99</b>
<b>DIY 2 KIT - 520/1040 to 2MB</b> ( 2 x 1MB cards ) SIMMS or SIPPS	<b>£119.00</b>
<b>DIY 4 KIT - 520/1040 to 4MB</b> ( 4 x 1MB cards ) SIMMS or SIPPS	<b>£235.00</b>

All RAM prices include VAT and delivery and come with instructions.

# ATARI STFM POWER PACK

- \* Atari 520STFM computer
- \* 20 top selling games (Afterburner, R-Type, Gauntlet 2, Super Hang On, Space Harrier, Star Glider, Overlander, Super Huey, Pac Mania, Nebulus, Eliminator, Predator, Xenon, Bombuzal, Bomb Jack, Double Dragon, Black Lamp, Out Run, Star Goose and Star Ray)
- \* Mouse, Joystick and instructions

ALL THIS FOR ONLY

# £299.00

including vat and delivery

# SM124 HI-RES MONOCHROME MONITOR

THE ATARI SM124 HIGH RESOLUTION MONOCHROME MONITOR is recommended for all serious applications on the Atari STFM / STE. For example: Word Processing, MIDI, DTP, CAD etc etc. Resolution: 640 x 400

STILL ONLY  
**£99.99**  
INCLUDES OF VAT + DELIVERY

**REMEMBER : ALL PRICES INCLUDE DELIVERY + VAT**

# AMIGA A500

all of the packs listed opposite come with:

- \* Amiga A500 computer + mouse etc
- \* DELUXE PAINT 2 graphics software

ALL THIS FOR ONLY

# £ 365.00

inc vat and courier delivery

## A500 BASE PACK

- \* Commodore Amiga A500 computer
- \* Modulator, Mouse + instructions

ALL THIS FOR ONLY

# £ 339.00

## BATMAN PACK

Batman, New Zealand Story and F18 Interceptor

## or FLIGHT OF FANTASY

Robot Monsters, Rainbow Island and F29

## or SCREEN GEMS PACK

Days of Thunder, Back to the Future II, Nightbreed and Shadow of the Beast II

## CLASS OF THE 90's PACK

CALL FOR DETAILS - OUR PRICE:

# £ 529.00

inc vat and courier delivery

## ST GAMES ONLY £1.75 EACH ?

Afterburner, R-Type, Gauntlet 2, Super Hang-On, Space Harrier, Star Glider, Overlander, Super Huey, Pac Mania, Nebulus, Eliminator, Predator, Xenon, Bombuzal, Bomb Jack, Double Dragon, Black Lamp, Out Run, Star Goose and Star Ray.

All of the above games are available in the Power Pack Software pack for only -

# £34.99

- that's less than £1.75 each!  
(requires double-sided internal disk drive)

# BEST PRICES

(DEPT NCE), UNIT A, GRAFTON PLACE,  
WORTHING, WEST SUSSEX. BN1 1QX



# (0903) 700714

TELESALES - 10am till 12 midnight  
ANSWERPHONE - 12 midnight till 10 am



All prices include VAT and UK delivery unless otherwise stated. All prices / specifications / special offers are subject to change without notice. Goods usually despatched same day as cleared payment is received.

Please make cheques/P.O.'s out to BEST PRICES. Mail order only, callers and collectors only by prior arrangement with us. Thank You.

ADD £5.00 IAC VAT FOR NEXT WORKING DAY DELIVERY, ADD £25.00 IHC VAT FOR SATURDAY DELIVERY  
ADD £12.50 FOR AM WEEKDAY DELIVERY, ADD £20.00 FOR 72HR COURIER DELIVER. / TO IRELAND

# WHOLE WIRED WORLD

A regular trip around the world with Steve Gold.

## SOFT LOGIK'S PAGESREAM 2.0 UNVEILED

Soft Logik of St Louis in Montana has announced it is working on release two of its popular *Pagestream* professional DTP system for the Atari ST.

Already available for the Amiga and the ST, version two for the ST is around three months away from shipment and, when it arrives, it is going to be fully compatible with the Atari TT series.

But the most important advance in 2.0 is going to be its support for *Agfa*, *Compugraphic's* hinted outline fonts and *Adobe Type 1* IBM format fonts. Font size support has been extended down to six points and up to 600 points and, as a result, it now includes some support for Bezier curves.

Surprisingly, despite the long list of enhanced features, *Pagestream 2.0* on the ST costs just \$299-95 - get your orders in right now!

Soft Logik Publishing Corporation, PO Box 290070, St Louis, MO 63129, United States. Tel: 010 1-314-894-8608 (voice) 010 1-314-894-0057 (BBS)

## MORE FROM WAACE

As the doors closed on the WAACE Atari-specific computer show in the US earlier this month, the *ST-Report* newsletter says that 3,600 of the Atari faithful made the pilgrimage to the show to check out what is happening in the Atari world. By all accounts, they weren't disappointed. Nice to read that Andy Bennett of Frontier Software in Harrogate made the trip to the US to show the US Atari fans that there is Atari life in England!

Star attraction at the show was, of course, Dave Small, of Gadgets by Small, who showed off prototypes of the company's forthcoming 68030 accelerator card for the Atari ST. The prototype at the show was installed in a Mega ST with the cover off, allowing all comers to inspect the workmanship - a far cry from other add-in cards for the ST (the laws of libel prevent me from saying who). The board - code-named the 68030 SST - should be available to end users by the turn of the year and, although a price hasn't yet been fixed, a

lot of interest was generated in this product. And no wonder, the board features up to 8Mb of 'fast' RAM, effectively turning a 4Mb Mega ST into a Mega 12. Despite the somewhat awkward change in choice of microprocessor and the boosting of RAM capability, Small reckons that most existing programs will run on the 68030 SST card.

And now for the bad news - initially, I'm afraid, the card in question is only going to be available for the Mega ST series, although other ST model support is apparently on the way. According to Small, standard ST and STe versions will have fewer features, since they will be optimised for smaller RAM configurations.

The 68030 SST card slots in, in place of the 68000 microprocessor on the Mega ST's motherboard. Because of the 030's system high performance, Small claims that its 16MHz performance is around 5.33 times faster than anything presently possible on a 68000 microprocessor-based ST, even with other accelerator and RAM-catching software installed.



• The delicious-looking Mega ST

Charles Johnson of Codehead Software's opening speech drew a lot of attention and appreciation as well, mostly because of his amusing and sarcastic prayer to Atari: "Our users, who are in Germany, Vanishing be thy name, Thy TT come, thy Lynx be fun, If you can find a local dealer, Purchase this day our daily disk, And forgive us our bugs, As we disembowel those who pirate our software, Lead us not into Cupertino, But deliver use from evil MS-Dos, For thine is the Fuji, And the power without the price, For ever and ever - or until the warranty expires".

## AMIGA ASSEMBLER FROM DOWN UNDER

Digisoft, an Australian company of Brisbane in Queensland, Australia, has released something known as *Macro 68*, a new assembler for the Amiga that is able support all the Motorola 68xxx family, including the 68030, 68882 FPU, and 68851 MMU. Amiga programmers will no doubt be pleased to hear that the multipass assembler package will support the new 68000-family assembly-language syntax, and it even comes with a module that converts old-style syntax source code.

According to Digisoft, the majority of *Macro 68's* facilities will be limited only by available RAM on the host machine. The software includes a full-listing control. Also included are full cross-reference capabilities, along with user-accessible files.

The Aus\$195 package will run on any Amiga - including the A1000 - provided that it has at least 1Mb or more of main RAM available.

Contact: Digisoft, 12 Dinmore Street, Moorooka, Brisbane, Queensland 4105, Australia, Tel: 010 61-7-277-3255 (voice) 010 61-7-277-8473 (fax)

## COMDEX COUNTDOWN

Comdex Fall is only four weeks away and already the excitement and interest are building up. This annual extravaganza takes place - as ever - in Las Vegas, home of the careless with their money. Already the US on-line services are starting to fill up with preliminary details of what will be launched and shown at the show of shows.

Seikosha is reported to be readying a notebook PC fitted with a 2-inch hard drive to save on weight. No pricing as yet, but the machine is bound to attract a lot of attention if it's as cheap as the Japanese giant's printers.

Also on the cards is an Ethernet/Token Ring wireless LAN system from a major name in the connectivity world, as well as a 16ppm laser printer - based around the Sharp laser printer engine - for under the magic \$4,000 (£2,000) mark. And who, pray tell, is the company performing this near-miracle? Let's just say that it is a major company down in Texas.

## FUNTIME AT NCR

At the US launch of a software package called *Co-operation* earlier this month, NCR executives are reported to have shed their previously stuffy and staid image in favour of a more fun-loving and hip style worthy of Steve Jobs and Steve Wozniak at the time when they were both in charge of Apple.

"Nobody can call NCR dull anymore," NCR chairman Charles Exley Junior told the press conference, as he put on a pair of dazzlingly bright red sunglasses fitted with flashing lights. That's true. It was only a month ago when NCR all but abandoned its allegiance to the Motorola 68xxx camp and revealed that a new range of Intel 808x and 80x86-based machines are now entering production.

Very interesting from a sartorial point of view, but what's going on? Obviously NCR has discovered that there is an important consumer market out there as well as the more traditional business buyers that have previously been their mainstay and have adopted an appropriate style. Watch out for some interesting developments on this front and keep reading this column.

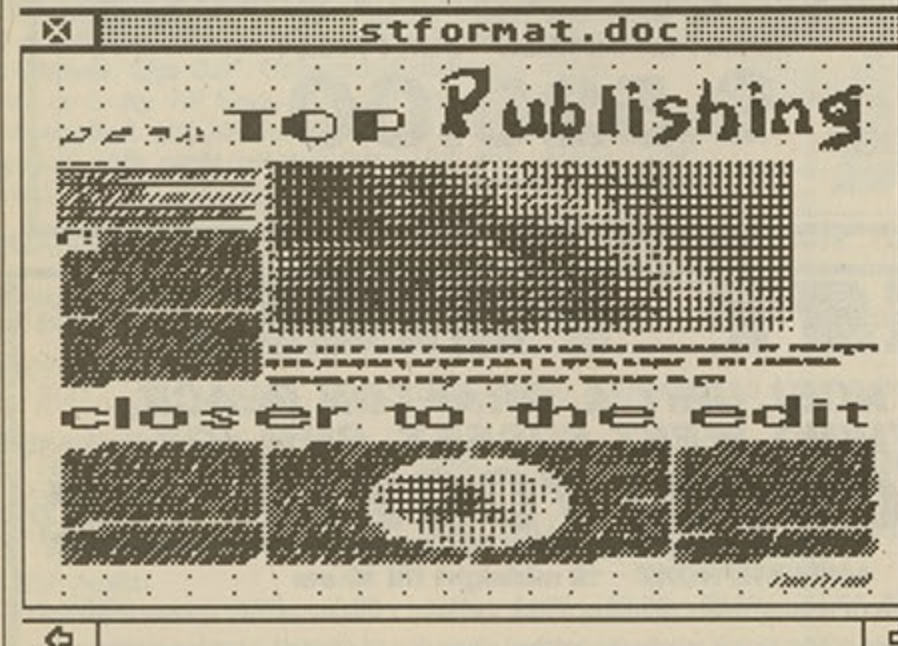

• *Pagestream 2* for the ST has arrived. A closer look at the desktop.



## COMPUTEACH YOUR WAY TO A CAREER IN COMPUTERS.

Computeach courses will help to turn your hobby into a rewarding career.

- No qualifications necessary. ● Thousands of computing jobs always need trained people. ● Thousands of Computeach students have already gained employment.
- Different courses for different abilities. ● Over 80% success rate. ● Established since 1964.

Send for your free Career Development Pack now - you don't even need a stamp - or call us on 0384 459521. NCE 25/10/C

Mr/Mrs/Miss/Ms \_\_\_\_\_

Address \_\_\_\_\_

Post Code \_\_\_\_\_

Age \_\_\_\_\_ Occupation \_\_\_\_\_

Tel: \_\_\_\_\_ (day) \_\_\_\_\_ (evening)

Send to: Computeach International, FREEPOST, Jews Lane, Dudley, West Midlands DY3 2BR. Telephone: 0384 459521.

**Computeach**   
International

**SPLINTER VISION LTD.**

## ASSEMBLER PROGRAMMERS

P.C. 8086 AMIGA/ATARI ST 68000  
SPECTRUM/AMSTRAD CPC Z80 C64-6502

Having relocated to Stroud (Glos) we are looking for people to join our expanding team of inhouse programmers to work on new and exciting products. If you have experience in one of the above languages and are interested in the leisure software industry please contact us on:

**0453 755512**

Venus 95%  
The Games Machine

BSS Jane Seymour 91%  
C&VG



Ultimate Golf 97%  
Your Amiga

Lotus Esprit 94%  
C&VG

## PROGRAMMERS AND GRAPHIC ARTISTS

Gremlin: 'Stronger than ever' ST Action

'Venus sets a newer, higher standard in ST software' ST Action

Gremlin's 8 bit Shadow of the Beast: 'An awesome achievement' C&VG.

Fancy working with the most consistently excellent software house around? Now's your chance. Gremlin are looking for programmers and graphic artists on all formats to join our successful in house team, who have been described as possessing 'flair, ingenuity and sheer skill' in the computer press. If you can match the impressive standards that Gremlin expects, we want to hear from you. We can offer excellent salaries, brilliant working conditions in our new offices, and a Ferrari for anyone replying within a week.\* We are also interested in developing freelance projects with experienced or new development teams. If you are interested in working for a company that prides itself on quality before quantity, then contact James North-Hearn or Sean Kelly at:

Gremlin Graphics, Carver House, 2-4 Carver Street, Sheffield, South Yorkshire. S1 4FS. Telephone 0742 753 423.

\* The Ferrari bit isn't strictly true. It isn't even slightly true. Actually, it's a lie. Sorry about the duff design, but we concentrate on quality games, not adverts.



# Twilight

An opportunity has arisen for a talented computer artist to work within our rapidly expanding in-house development team.

The successful applicant will work on a variety of projects for all major home computer formats and various consoles.

We are currently working on arcade conversions, licensed games and original designs for leading software publishers.

We offer a competitive salary with regular pay reviews.

If you are interested in being known for working on quality games rather than bulk product then phone Pete or Stuart for an informal chat at **Twilight** on Harrogate  
(0423) 500399.



## PAL Developments

### SHEFFIELD BASED COMPUTER PROGRAMMERS

*PAL Developments has vacancies for experienced programmers to work on a variety of computer game based projects. Many of these include internationally famous cartoon characters.*

*An excellent working environment alongside an already established dedicated team of programmers. Programmers should have experience of working with either Z80/6502/68000, PC.*

*Salary is negotiable and will reflect the importance of this position.*

*In the first instance apply, preferably in writing, to Mr. A. D. Palmer at the address below, or telephone for an appointment.*

*Citizen*  
SOFTWARE

4/5 BARMOUTH COURT,  
BARMOUTH ROAD,  
SHEFFIELD S7 2DH.  
TEL: 0742 587555  
FAX: 0742 580547

**PAL**  
Developments  
PALMER ACOUSTICS LTD.  
10 YEARS 1977-1987



## DO YOU WANT TO BECOME A PROGRAMMER?



Established 1968

**Move across to the rewarding  
world of IT.**

We have a series of short and long term training programmers in Computing and Information Processing.

- \* C & G 424/425 Certificate in applications programming.
- \* C & G 418 Computer Programming & Information Processing.
- \* Evening courses in DBASE, WP, Spreadsheet Analysis.
- \* Evening courses in Pascal, BASIC & COBOL.

Contact Central London College on  
01-580 4596.

**TRAINING FOR YOUR FUTURE**

## SALES PERSON

Must have good  
knowledge of **PC's**  
and/or **Acorn** product.

Apply in writing **ONLY**,  
with full C.V. to:

**The Manager,  
Computer Depot,  
205 Buchanan Street,  
Glasgow  
G1 2JZ**

**Branches in Edinburgh & Dundee**

# CIRCUIT CITY

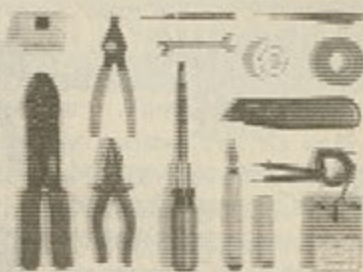

As our main man Keith Pomfret is currently touring the Soviet Union, enter Pat McDonald as the man with the mains, telling you how to control two computers simultaneously.

There was a time when it was the realm of the true hardware nut to link computers together – even machines of exactly the same make and type. If you had two computers, you needed two keyboards, two monitors and two pairs of hands (think about it).

With the advent of the WIMP system, pioneered by Xerox and Apple in the extremely successful Macintosh system, all that changed. Here's why:

WIMP systems rely mostly on mice for people to interact with computers. Keyboards are pushed to one side, because most of the time they're simply not needed. This week's CC looks at the possibilities of controlling two (or more) computers simultaneously with just one mouse!

## WHO NEEDS IT?

For a start, you need two computers, which most people don't have. But, surely you know somebody else with a computer? Preferably a computer where the mouse is compatible.

Now, just as an exercise, imagine you have say two STs. These very nice machines have built in MIDI ports, to talk to synthesizers. What if you want to control more than 16 MIDI devices at once? MIDI is limited to 16 channels and although there are ways round this, most of the sequencing software available at the moment has a limit of 16 different synthesizers/drum machines or whatever.

Plus you have the problem of sequencing them all exactly. MIDI signals usually start to misbehave after passing through five or six instruments without MIDI splitters or synchronizers, and you have a problem.

Assuming you have two computers, you could control two sequencing programs with one mouse. And you synchronize the two programs by pulling down the play option with one mouse on at the same time on just one machine.

**PROBLEM:** If your two computers are always connected to the same mouse, they will behave exactly the same all the time. That's not what is needed – you need to have independent control when you want, and simultaneous when you want...

What is needed is a box, with an input for your mouse at the front and two leads coming out of the back to plug into the mouse ports of two computers. Of course, you could control more machines by having more leads, but this still leaves us with the problem of

## WHO ELSE NEEDS IT?

Let's talk Amiga for a moment. The Amiga is blessed with four separate channels on which to play samples. What if you want more than four samples playing at once, without spending lots of money on hardware?

If you can blag/borrow/steal another machine, and could control both machines with one mouse (when you needed to), you could select two different play options at the same time. Giving you eight sample channels to play with.

sometimes not controlling two computers.

So, you mount a switch on the front of the box. This has three positions:

- 1) Feed the mouse signals to one of the leads.
- 2) Feed the mouse signals to the other lead.
- 3) Feed the mouse signal to both at the same time.

Sounds easy, doesn't it? Well, here's where it starts getting a bit fiddly. Assuming that you are trying to build a box for an ST or Amiga, you will need the following components:

- 1) A box!
- 2) Two female 9-pin D connectors.
- 3) One panel mounted male 9-pin D connector.
- 4) Sufficient eight core screened cable (use the screen for the ground connection).

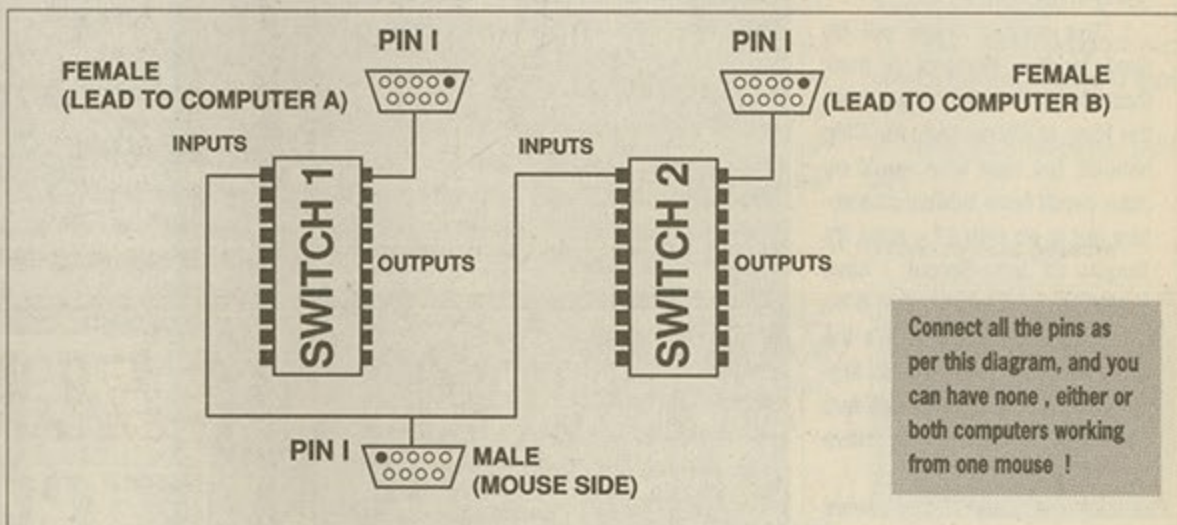

- 5) One 9 pole triple travel switch.

The last item is rather rare. In fact, it's non-existent, which is probably why nobody has ever built such a box. You could get some tame techie (*the author lacks this quality – Ed*) to make some solid state circuitry – ie use a few off-the-shelf chips and wire them up in a most improbable fashion to a standard three-way switch to get the desired effect.

However, there is an alternative. Rather than have one switch, use two. So item five now becomes:

- 5) Two 9 pole single travel switches

## SWITCH INFO

For those who've never really thought about it, this talk of 9 or 10 pole single or triple travel switches is a bit nonsensical. A switch works by:

- 1) Having an input (one of the poles).
- 2) Having a travel (connected/not connected).
- 3) Having an output (another pole).

A single pole, single travel switch (just like a light switch) would have two contacts (one for in, one for out) and would be on or off. A 10 pole, single travel switch would have 20 connections – 10 inputs, 10 outputs, and again they would all be either on or off.

## DISCLAIMER

Express, or its parent company, Future Publishing, takes no responsibility for damage incurred by connecting some Heath Robinson circuitry as specified by Pat McDonald. Nor does he.

Again, it's not common – you'll probably have to settle for 10 pole single travels and not use a pair of connectors. Or you could acquire lots of little switches, and switch them all over simultaneously. DIP switches would do the job fine, so long as you could get at them without taking the box apart.

## WIRING IT UP

This is the really fiddly part – not intellectually, just a bit tedious. From the male connector (where you plug the mouse in), you have to run two wires back from each connection to the two different sets of switches.

From the switches, you have to run one wire to

each of the female connectors (the ones you plug into the computers). Each of the connections should be from the relevant pin to the same pin on the opposite connector, with a switch contact in the middle.

For example, pin 1 of the male connector has to be connected to both banks of switches. From each switch output, a wire is connected to pin 1 of each female connector. The above diagram might help to clarify things.

Exactly the same is true of pin 2, and pin 3, until every pin on the mouse side is connected to the same pin on each of the computer connectors – but with a switch in the middle. In case you're wondering, the pins are numbered clearly: but you usually need a magnifying glass to make them out. Congratulations, you are now a grade one hardware nut! ■

## SOURCES

Maplin Catalogue from WH Smiths or telephone 0702 554161  
Tandy – a branch in most major towns or telephone 0922 710000  
Any local electronics shop (where you get good advice as well)  
Computer/radio jumbles and fairs, but be careful what you buy, unless you know what you're looking for.

## OPENING TIME

**T**here's good news and bad news this week. The good news, for me, is that I'm off to the US of A for a couple of weeks. The bad news, for you, is that I won't be writing The Centrefold.

I have managed to draft in two plenipotentiaries. I use this word wisely as they will both be a damned sight more diplomatic than I ever am. The first of my plens is known and loved by all long-time *Express* readers - it's Count Ken Mosely. New readers should be aware that Ken has recently returned from Tehran and is presently residing in cyberspace. You should also note that a Kennism follows roughly these lines "I'm not advocating that these people should be rounded up like dogs, doused in petrol and torched... but sooner or later someone's going to get hurt."

The second week will be filled by the immoral (I think that's what I mean) prose from the King of Computers, Mr Chip himself, the man who would be Jobs (*what have biblical characters got to do with it? - sub*), it's Tarquin St John-Sprout. I have made Tarquers aware that if he screws this one up then it's the wet towel run, and back to fagging at Eton. Tarquin is 42 years old and still thinks they have fagging at Eton.

By the way, I don't want you to think I'm in the States for pleasure. Far from it. My itinerary is full. First off there's a three day meeting with our man on every coast, Joe Sixpack. Joe tells me there's a major convention of Jack Daniels Lovers for a Caring Micro. Following this I will be visiting several AI labs, interviewing William Gibson, Steve Wozniak, Bill Gates and the head honcho at IBM... or then again maybe not.

Whatever happens you can be sure that my new NeXT laptop - the first in the world - will accompany me. I have only just taken delivery of the machine and am a trifle concerned that it won't be up to the standard of my Cambridge Z88. Still, exploration, discovery and analysis are the driving forces behind any serious computer journalist and I guess I'll just have to suffer the change.

That's it then, I'm off to work my fingers to the bone. I hope my two stand-ins serve you well. I'll see you soon.

# Tim Smith's CENTREFOLD

Write to 30 Monmouth Street, Bath BA1 2BW (if you dare)

## FROM THE ARCHIVE

A year ago we were all younger, more naive but less "in touch with ourselves". What was going on in the world of Computers? Only *Express* really knew, and only The Archive can tell you now. So read on...

### IT DOESN'T QUITE FIGURE

"Amstrad faces cash crisis" screamed the page one lead headline. Amstrad's year end figures did not look too good with "plunging profits, mushrooming overheads, a cash deficit and huge stocks of unsold machines." Its share price had dropped from a high of 208p to a mousey 47p. There were £200m worth of computers waiting to be sold... and even worse than that Orient were still not in the 1st Division. Do me a favour... plug me into a saver!

### MAD AS A WALLOON

The Belgian Stock Exchange ran into problems when its computer system crashed. A spokesman for the BSE(!?) said "International dealers have been ringing up and asking what happened to our Mickey Mouse computer system."

### BILLION DOLLAR DRAIN

A major UK bank was reported to have lost £2 billion because of a computer error (well it would say that wouldn't it).

### IS THIS TRUE?

"Programmers aren't boring" Another screamer of a headline proclaimed that wireheads weren't "sickly loner[s]". This was according to a report published by Dr Margaret Shotton. We commented "The research was based on a sample of only 106 recipients (I think they meant replies but it was before my time) to advertisements... One could argue that real [computer] dependants would be too obsessed to even notice

the adverts let alone reply to them."

### PCW YOU OFF

The Mini Office Professional debacle continued for the PCW and its owners. Database Software decided to market the Plus version without the spell checker or thesaurus.

### SEND MORE BRAINS

Britain's first professor of Neural Networks managed to develop an "artificial brain cell". Prof Igor Alexander put together the G-RAM, the G stood for Generalising. It was supposed to make the standard silicon chip act like neural networks.

### HA HA HA

"Seen at a meeting: 'Hacking should it be made an offence?' The opening speaker was Mr Timothy Hackworth, British Computer Society."

### SUGAR DADDY

"I'm no longer going to chase profits to keep the Stock Market happy." Alan Sugar commenting on Amstrad's poor financial showing.



## CAPTION FULL STRENGTH

Last week's 'I Wish I'd Said That' section contained a quote relating to the Nob Box. It should also have had a picture of said device. There are two possible reasons for the non-appearance of said pic:

- 1) There was a massive foul-up on the art side or
- 2) I wanted to save it for this week's Caption Full Strength. You can make up your

own mind as to which is the true reason. Still, I didn't want to waste the pic so this week's CFS is a little different. I want you to tell me exactly what the box could be used for in order to have gained its marvelous moniker.

If you read last week's Centrefold (which came with a free wrap-around copy of *New Computer Express*) then you'll have some idea of its true use. I don't want to hear

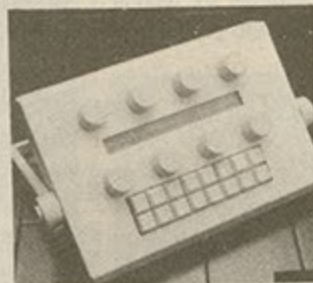

about that. Be witty and send your attempts to 'Ho, ho, hee, hee It's the Nob Comp' at the usual address.

## THE CHARTS



This week I have great pleasure... but first the Bleeding Charts Club. Due to some marvelous detective work by Dave Golder [see the flannel panel on page 10] (*for those too lazy to turn the pages - he's our very own news assistant and he assists with the news - sub*) I have managed to get hold of Vincent Van Gogh's top 10 pieces of software. Get up and get funky Vince.

- 1) I'm not too happy about this.
- 2) Deluxe Paint 4 I suppose, but only on my ST
- 3) Top Gun [for the stupid among you, Vincent shot himself]
- 4) Moonwalker... someone who's wackier than I
- 5) Risk
- 6) Fire and Forget
- 7) No Exit
- 8) The Last Days of Doom
- 9) No bloody samplers for a start
- 10) That's it... I've got to shoot off now.

Lovely jubbly Dave.

# REFOLD

## THE TOSH TEN

This week's dross courtesy of Dave Stanworth of Penmaenmawr. Funny stuff and enough crawling to get into Letter Spray as well. Llan-undo something-something goch-a-gorch [that's well done in Welsh according to our resident linguist Colin Campbell] Dave. It's software to match personalities

- 1) *Elite* - Tim Smith
- 2) *Killing Game Show* - Bruce Forsyth
- 3) *Personal Nightmare* - Maggie Thatcher
- 4) *Weird Dreams* - Neil Kinnock
- 5) *Unreal* - Brigitte Neilson
- 6) *Speed Ball* - Ben Johnson
- 7) *Powermonger* - Saddam Hussein
- 8) *Pirates* - British Telecom
- 9) *Running Man* - Salman Rushdie
- 10) *Defenders of the Earth* - The Green Party

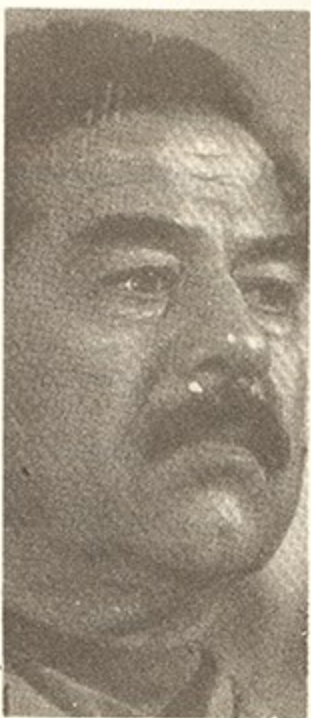

## The centrefold American tour highlights

(At least Smithee's version for his public - sub)

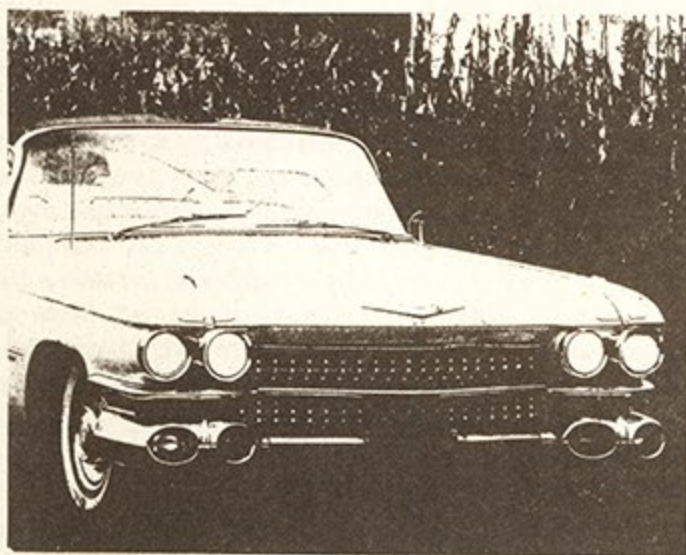

**Nov 1 13:00hrs:** Take off. Be sick. Drink some bourbon. Be sick. Try not to talk to fat pipe-cleaner sales-woman from I-buck Wisconsin. Eat. Be sick. Drink. Swap addresses.

**Nov 1 17:20hrs:** (Eastern Standard Time): Land. Clear immigration. Sign chit for luggage retrieval from Amsterdam. Go to bar. Drink. Meet Sixpack. Go to hotel. Eat. Discuss bio-chip technology. Sleep.

**Nov 3 07:30:** Power breakfast with Wozniak at the Gazebo County Bar-B-Q and Knack-wurst House on highway 17. If the Express US office hasn't arranged this then onto the beach for a drink and some sleep.

**Nov 5 09:00:** Day off. I shall celebrate Guy Fawkes' day in some style, as I hear from my colleagues who have been to the States that all I have to do is walk into any house and say "Hell, let's celebrate the blowing up of a king in the 17th Century!" And I'm bound to have a good time.

**Nov 8th All Day:** Prepare for William Gibson interview by drinking lots and plugging my finger into the live socket... or maybe not depending on how I feel.

**Nov 9 13:00:** Attempt to locate Gibson at the local Almeida

Inn. Remember to wear loads of chips, disks and general computer bits and pieces. Also remember to ask him why his books fall into the Emperor's new clothes syndrome. Failing this, go the beach for a drink and some sleep.

**Nov 14 All Day:** Prepare for interview with head honcho of IBM by putting on faceless mask, wearing dark blue single breasted suit with single vent, two button cuff and no turn-ups. (and look-like-but-are-much-cheaper Timberlands? sub) Also practise saying "Could this scenario be detrimental in a long-term, multi-user, visionary type interactive-based society... or what pal?" Maybe not, I'll see how I feel.

**Nov 15 05:45:** Power breakfast with IBM at IBM Hall, IBMville, IBM County, North IBMachusetts. Remember to look impressed, awake and not Pro-Plused out of my tree.

**Nov 16 All Day:** Say goodbye to Joe Sixpack at his ranch in Bootsville. Say cherio to Lindybell-Billbob Binks anywhere I can and for as long as possible. Wipe the laptop and phone Andy Editor to say that I got mugged by magnet wielding freaks so all the work has been lost.

**Nov 17 08:00:** Fly home.

## I WISH I'D SAID THAT

Have you seen, heard or read anything even remotely computer related which has made you stagger around the place in amazement? If so, send it into IWISH at the usual address.

"Powermonger? I could have written that, it's easy. I just didn't want to because it's like fascist you know" A mindless hippy programmer who managed to get through to the Express office on the phone.

"In other campaigns, there may be more than one flag, but this [campaign] has only two." From Domark's *Ancient Art of War* manual.

"No soap, no hope dude!" A Teenage Mutant Hero Turtle making a rather dubious reference in the TV cartoon.

## TALE SPIN

This is the section of The Centrefold which makes Sheherazade look like a person with very little stamina and no imagination whatsoever. All I have to say to those of you who have commented that Mel Croucher's Computer Chaos was more interesting, is that while Mel is a man of quick-fire wit and repartee, he no longer writes Computer Chaos. You could always put your criticisms where your mouth is and send in some stories. Failing that, just lean back in your chair and read these.

Valley had only just got going. Within it were groups of eager young sorts setting up in defiance of the mega-corps such as IBM. Two such companies were called the Itty-Bitty Machine Company - yup it was a hippy IBM. Another went by the name of Kentucky Fried Computers.

### And finally a joke

Q: How many programmers does it take to change a light-bulb?

A: None, it's a hardware problem.

Thank you and goodbye

### A quick bit of history

The first spreadsheet ever developed was by David Bricklin at the Harvard Business school in the late 70's.

### The apple of knowledge

Back in the mid 1970's (a bit of nostalgia this week) Silicon



• The granddad of all spreadsheets.

## CAPTION FULL STRENGTH II

This picture demands someone to come up with an extremely witty caption. Ms Hanks thinks that these two gents are "dishy" - but then again she thinks that Bela Lugosi was sex on legs so what can I say. They are two Capital Radio DJs at the London Rock Garden. In the hands of one of these gents is a spanking new Gameboy games machine. Why do they look so completely out of it? What game are they playing on the machine? Where are they going afterwards? Can you find answers? If so send them to "Its the Two DJs and the One Gameboy I Think" Comp at the usual address.



**ISSUE 98  
AND 99  
WINNERS!**

**Y**es, do you remember way back in Issues 98 and 99? Ok so this was before we were all properly acquainted, but cast your mind back anyway. There were a number of competitions therein. Issue 98 contained that picture of the two young ladies and also a Sound of Music comp. The idea was to spot the mistakes. Many people did, but only two people could win. These lucky people are:

Jaco Cebula of Dunfermline... I wonder if you can get my bike out of Dalgety Bay matey?

A Wearing of Solihull... the nice end of town eh chummy?

I'm awfully sorry about this but some basket used all the blank disks so I'm going to have to send A Wearing a copy of SAS Combat Simulator by the Codies. Jaco gets the chance to play the now near legendary Navy Moves from Dinamic. Well done chaps and apologise for the lack of blanks.

Of course Issue 99 also contained two comps. We'll start with the Alf Garnett game... Ash Jones of London was the lucky winner here. He knew the answers and was prepared to make his move at the critical moment. Ash you win a copy of Skruil for your A500.

The Caption Full Strength comp that week showed a cup of brown liquid being lovingly held but a thingy. I got hundreds of "nice cup of ST" kind of captions and not to put too fine a point on it - they were dull. So, the winner was P G Spear of Congleton for his "New!! Amstrada the sugar free pick-me-up". Good old lolo Davidson also had a crack with "No, no! You're supposed to dunk the donut (that's doughnut in the the UK lolo baby, who says you're not American?) in the coffee." Neither of you two told me what you wanted to win, so write back. No phone calls because I don't take them. More next week.

**Letter Spray**

Want to see your name in print? Then write to Centrefold. This week's replies by Pope Alexander I's hairdresser's son's wife's insurance dealer.

The most completely trivial and offensive letters page in any magazine in the world. Would you like to be abused, humiliated and generally made to feel small by what has been called a frivolous boil on the face of computer journalism? Then write to Letter Spray. If you just want to be abused, humiliated and made to feel small without worrying about computers then just appear on Catchphrase [with or without Roy Walker].

Dear Tim (enough pleasantries get on with it creep)

The mistake (puke) in issue 96 (chunder) pg 56 was in the letter (technicolour yawn) headed 'Electronic Asylum' reference (spelling. Come on come on!) being made to a 5.35 inch Disk (since when has disk been upper case then eh?)

Apart from 'anonymous' who gives a toss? Pedants like that make me - you guessed it, SICK!

Yours Don Griffith, Hammersmith

Dear Don,

You're my kind of reader. Keep 'em coming but please try to be less familiar. After all when you're a cutting edge, industry figure with contacts all over the place, as well as being a guru to many major computer firms you won't want members of 'the public' calling you by your first name will you? As to your very astute point, we have sent Keith [Luciano] Pomfret to Russia for his sins. Nice letter, hey, why not send some more?

Dear Tim (blinking heck! Would you clots stop this!)

A mistake in NCE? Heaven forbid. perhaps (we like to start sentences with upper case letters where I come from) a finger error. Electronic Asylum article quote "but definitely not least the 5.35 disk" So this is what Anonymous is beefing about. I am going back to my snooze pattern. Bye Bye

Yours Stanley Whibberley, Par.

Dear Stanley (I can't help I have to laugh)

Blah, blah Keith, blah Russia, blah blah secret plans, wibble, wibble (sorry, no really) . Wibble blah, sub-editor shot. (Call that a gun Smithee? - sub) Get it? Got it? Good. Now clear off. And hey, why not subscribe?

Dear Tim (ahhghgaghhg / Another one!)

I went to the Joan Junor School of journalism (see Centrefolds passim) as well - in fact I think I sat behind you. (yes it was me flicking your ears).

Yours S Davies, Long Buckby

Dear S,

Your letter went on to tell me about some appalling ST pun for the coffee cup caption comp, but you know that don't you? So you were the little squirt who caused me such agony as a tender young student. I have your address and am sending my pals, Andy [think it over creep] Smith, the editor of Sega power, Matt [don't push me] Beilby of Your Sinclair and Marcus [did you call my whippet a Southerner?] Dyson art editor of Amiga Format around to rip your tongue out and use it for a drive belt. Thanks for writing and please write again.

Hi Tim (it gets worse)

Great, brilliant, and amazing just about describes the wonderous 'Centrefold'. No, I'm not creeping. It's just good to find some humour in an otherwise serious magazine. I've bought NCE from issue 2 (issue 1 was free remember?) and I have always enjoyed its great layout. The only trouble was the lack of humour. I'm not saying that it was completely bleak, but it never managed more than a brief smile. The Tosh Ten (issue 101) had me in stitches - Matthew Miller deserves a medal.

Yours mirthfully, Dave Stanforth.

Dear Dave,

Nuff said really. Matthew will be receiving some stuff soon.

**DISPATCHES**

The Centrefold has friends world wide. This week's foreign correspondent is Private Jean Aoun. Jean is presently staying with his brother Michel at the Hôtel des Embassies Français in Beirut.

Hi there,

I haven't been able to get out much of late and so don't have a great deal to report. Michel has locked himself in his suite where he's playing UMS II which is the latest version we have over here. When I do get the chance to get into town I go and see my man, Mickey Hirawi. He's recently bought a Tandy WP2 which we have been trying to get to grips with in between the shelling - the main problem is that we can't find the disk drive.

After seeing Mickey boy,

it's off to the Ashrayfiyeh district to check out the real computerised hardware we have over here. My buddy Sam Geagea uses a Spectrum +3 and also has 24 artificially intelligent anti-personal mines, fourteen laser sighted sniping rifles, an armoured personnel carrier (called Barney) which use a 32-bit bus to evaluate incoming guidance data. He still can't get World Cup Carnival to play properly.

Once all my visits are made, it's back to the hotel for a quick conference with M

Guy de Cabinêt the deputy assistant under secretary to the standing sub-committee on bloodletting. He's got a Viglen 286 which he uses for word processing and PGA Tour Golf. The real shame here is that he's back to France next Wednesday and my best round is still 98.

That's it for now. They've started shelling again and I don't want my LocoScript master disks to get dusty. See you soon, love to the readers, send payment in Yen and cheers to Ms Hanks for the beige and cream flak jacket.

**THE OUT  
OF TOWN  
TOP TEN**

The Centrefold goes out to where the real people play. Into the heartlands of computing. I have no snobberies relating to places outside of my home. This week's Out of Town Top Ten (can anyone think of a better name?) comes from Cyber-Tech of Dursley. Kevin Stenner is the guv, and a jolly affable chap he is too. He has sent us the Top Ten games for the Mega Drive. If you want to find the shop which does all thing console go to Interstate House, 40 Long Street, Dursley, Glos, GL11 4JB or call on 0453 544582.

- 1) Strider (Arcade conversion. Hack'n'slash)
- 2) Batman (need we say more?)
- 3) Insector X (Import from Japan, don't really know much about it)
- 4) Golden Axe (another arcade conversion. Excellent)
- 5) Hellfire (more from Japan)
- 6) SWAT (shoot, kill, maim, horrid fighting stuff)
- 7) Super Monaco Grand Prix (drive with style)
- 8) Fatman (I think this is a wind-up. Has anyone played it?)
- 9) Klax (Brain busting puzzle game)
- 10) Moonwalker (maybe not a thriller but fairly bad)

Why not force your local shop to send us in a chart or two? You could get a name check too.

**PLEASE NOTE  
YOU PEOPLE**

The winners of the Lynx and All Format Fair comps from issue 102 will be announced next week. I have to write this lot this week. This is rather strange really because it looks like the lucky peeps won't get the prizes in time. Not true. All will be well.

OUR  
**PC KITS**  
 COST LESS THAN OUR BITS  
 (which are pretty competitive anyway!)



	8 MHz XT one 360k floppy	12 MHz AT 20Mb HD	16MHz 386SX 42Mb HD
<b>Our Parts Prices</b>			
Case	42 Universal	43 Universal	55 de luxe
PSU	33 150w	33 150w	53 200w
Keyboard	33 101 key	37 102 key	37 102 key
Mainboard	55 8 slots	115 7 slots, up to 4Mb	259 8 slots, up to 8Mb
RAM	35 512k	46 512k	93 1Mb
FDC	17	24	49 inc ser and par ports
Floppy	51 360k	62 1.2Mb	62 1.2Mb
HDC		37	On drive IDE, 8K cache
Hard Drive		150 20 Mb	253 42Mb, 27ms, 8Mbps
Monitor card		21 MGA	21 MGA
Monitor		79	79
<b>Total of parts</b>	<b>266</b>	<b>647</b>	<b>961</b>
<b>Our kit prices</b>	<b>219</b>	<b>591</b>	<b>899</b>
including the same items		Prices exclude VAT and Delivery	(MS DOS - 39.00)

Kits also include full assembly instructions and diagnostics, many configurations available. Full range of Barebone Systems and Add-Ons at equally competitive prices. E.g 386SX barebone - 359.00, 386-20 Barebone - 604.00, 1:1 MFM/FD Controller - 65.00, 1024x768 VGA Card - 85.00, VGA Colour Monitor - 250.00, Baby Tower Case - 55.00

So if you are thinking about building your own machine to find out what really makes a PC tick or to save some money and would like a kit that really is a kit - or if you are interested in our Barebone Systems or high quality add-ons.

For a brochure, price lists, spec lists etc. Contact:-

3TH Ltd, P.O. Box 482, Oxford OX2 9RP Tel 0865 791452 Fax 0865 794267

TEL: LEEDS (0532) 637988

## FIRST CHOICE COMPUTERS

UNIT 8, ARMLEY PARK COURT, OFF CECIL STREET, ARMLEY, LEEDS LS12 2AE

ALL PRICES INCLUDE VAT & DELIVERY. ALL OUR PRODUCTS ARE GENUINE UK SPECIFICATION. FULL REPAIR SERVICE AVAILABLE FREE ESTIMATES

NEW LOW PRICES

### HARD DRIVES

#### AMIGA A590 20 MEG

The Commodore A590 has a built-in unpopulated RAM board, so you can easily upgrade your Amiga memory by up to 2 megs without invalidating your warranty. (Autoboots 1.3 only)

**£349.99**

Add £40.00 for each 1 meg of expansion

#### AMIGA A590 20 MEG With 2 meg of RAM £429.99

DRAM CHIPS (256\*4) TOSHIBA, SAMSUNG, MOTOROLA, INTEL.

Quantity 4 + .....£5.49 each  
 Quantity 8 + .....£5.19 each  
 Quantity 16 + .....£5.00 each

### DISK DRIVES

CUMANA AMIGA .....£71.99  
 CUMANA ST .....£77.99

### COMPUTERS

**NEW AMIGA SCREEN GEMS PACK WITH BACK TO THE FUTURE 2, DAYS OF THUNDER, KNIGHT BREED, SHADOW OF THE BEAST II & DELUXE PAINT II**  
**£369.00**

**NEW XMAS PACK**  
 ALL YOU NEED TO GET STARTED WITH YOUR AMIGA. INC. 3 EXTRA GAMES, 10 DISKS, MOUSE PAD, CRUISER BLACK JOYSTICK, AND DUST COVER. ONLY £30.00 EXTRA WITH ANY AMIGA PACK

**AMIGA CLASS OF THE 90'S**  
 INC: KINDWORDS 2, MAXIPLAN SPREADSHEET, SUPERBASE II, MIDI/MUSIC SOFTWARE, GRAPHICS SOFTWARE, DTP, MOUSE, MODULATOR, 10 DISKS, MOUSEMAT AND MORE!!!  
 NOW WITH 1 MEG OF RAM  
**£549.99**

**ATARI 520STFM DISCOVERY PACK**  
 INC: 4 GAMES, STOS, NEOCHROME, FIRST BASIC  
**£279.00**

**ATARI 1040 STE EXTRA PACK**  
 INC: 1ST WORD, ST BASE, ST CALC, ST GRAPH, FIRST BASIC, S.T.A.C. ADVENTURE CREATOR, HYPERPAINT, PRINCE (STRATEGY GAME), METACOMCO BASIC, MOUSE AND MANUALS  
**£429.00**

NEW

### NEW STAR PRINTER RANGE OUT NOW!

**PC200 COLOUR 9 PIN** 180 cps draft, landscape printing, 8 resident fonts  
**£214.99**

**PC 24-200 24 PIN** 222 cps draft, 10 resident fonts, landscape printing  
**£259.99**

### PRINTERS INC LEADS

STAR LC10 MONO .....£159.00  
 STAR LC200 COLOUR .....£214.99  
 STAR LC24-200 .....£259.99  
 CITIZEN SWIFT 24 .....£289.99  
 SWIFT COLOUR UPGRADE .....£34.99  
 EPSON EPL700 LASER .....£919.99

### AMIGA 2 MEG BOARDS

512K POPULATED .....£56.99  
 1 MEG POPULATED .....£93.99  
 1.5 MEG POPULATED .....£114.99  
 2.0 MEG POPULATED .....£129.99  
**RING US FOR DETAILS NOW!**

NEW LOW PRICES

### 3.5 INCH DISKS

**SONY/VERBATIM BULK100% ERROR FREE, 135 TPI LIFE TIME GUARANTEE**

QTY £  
 10 .....£5.99  
 25 .....£13.99  
 50 .....£25.99  
 100 .....£47.99  
 200 .....£86.99  
 300 .....£115.99  
 400 .....£149.99  
 500 .....£179.99  
 1000 .....£349.99  
 DISK LABELS 500 .....£7.99  
 DISK LABELS 1000 .....£13.99

### MONITORS INC. LEADS

PHILIPS CM8833 .....£239.99  
 COMMODORE 1084 SD .....£259.00  
 ATARI SM124 .....£109.99

- OPEN MON-SAT 9.00AM - 5.30PM
- SUNDAY OPENING 10.00AM - 3.00PM
- THURSDAY NIGHT LATE TIL 8.00PM

- FAST MAIL ORDER SERVICE
- FREE POSTAGE UK MAINLAND
- FREE 2-3 DAY COURIER SERVICE
- SPACIOUS FREE PARKING
- FULL REPAIR SERVICE FREE ESTIMATES

CALL INTO OUR SHOWROOM OR ORDER BY TELEPHONE  
**TEL 0532 637988**  
**FAX 0532 637689**



## CHRISTMAS SPECIALS

## OFFER 1:

Double Sided 3 1/2" Disks, Individually Wrapped, 880k 135 tpi. Ideal for Amiga, ST, etc., Blue, Pin No., made in Japan, 100% Error Free. 2 for 1 Warranty or money back.

10 x 3.5"	£4.90
25 x 3.5"	£11.95
50 x 3.5"	£18.50
100 x 3.5"	£36.00
250 x 3.5"	£87.50
500 x 3.5"	£169.00
1,000 x 3.5"	£310.00

Inc. labels

Amiga 512K  
upgrade only  
£34.95 inc VAT

## OFFER 2:

Genuine Sony 3.5" Disks Double Sided, made in Japan, sold in Sony outers, probably the best disk in the World!

10 x 3.5"	£5.90
25 x 3.5"	£14.35
50 x 3.5"	£26.48
100 x 3.5"	£49.78
250 x 3.5"	£123.95
500 x 3.5"	£199.50
1,000 x 3.5"	£369.00

Including labels

3 1/2"  
DISKS FROM  
31P Inc VAT

## OFFER 3:

5.25" Double Sided 48/96 tpi for IBM PC and Clones, etc, 100% Error Free, 2 for 1 warranty or money back.

25 x 5.25"	£6.95
50 x 5.25"	£14.95
100 x 5.25"	£23.00
250 x 5.25"	£56.95
500 x 5.25"	£112.95
1,000 x 5.25"	£200.00

Complete with labels, envelopes & w.p.'s

Star LC10 Printer  
£158.95 inc. VAT  
Star LC10 Col. Printer  
£199.95 inc. VAT

## OFFER 4: High Density Disks.

when only the Very Best will do.

5.25" HD 1.6mb  
for IBM, AT, Etc.

3.5" D/SHD 2mb,  
made in Japan,  
HD in corner of Disk.

10 x 5.25" HD	£4.60	10 x 3.5" HD	£11.00
25 x 5.25" HD	£11.00	25 x 3.5" HD	£27.25
50 x 5.25" HD	£21.50	50 x 3.5" HD	£40.00
100 x 5.25" HD	£42.00	100 x 3.5" HD	£79.00
250 x 5.25" HD	£100.00	250 x 3.5" HD	£169.50
500 x 5.25" HD	£197.00	500 x 3.5" HD	£356.00

Including Labels, Envelopes & w.p.'s  
100% Error Free. 2 for 1 Warranty

## OFFER 5: 'Keep your data safe'

Top Quality Anti Static Lockable Disk Boxes, complete with 2 keys, Small or Large Capacity, ideal for Home or Office use!

3.5" x 40 Capacity	£3.95
3.5" x 80 Capacity	£4.50
3.5" x 100 Capacity	£5.50
3.5" x 120 Capacity	£6.50
5.25" x 70 Capacity	£3.95
5.25" x 100 Capacity	£4.95

## OFFER 6: Accessories;

Sourced from the world's leading manufacturers, Quality and Price Guaranteed, Buy with Confidence

Amiga/ST dust covers	£1.95
Universal Screen Filter	£14.95
3.5" or 5.25" Cleaning Kit	£1.95
Mousemat	£1.95
200 Labels	£2.99
Roll of 1,000 Labels	£7.50
PC or Amiga Cable	£5.95
Mouse House/Bracket	£2.40
Printer Stand with Tray	£13.99
Printer Stand	£11.95
Mouse/Joystick Extension	£3.95

Call for printer ribbons prices

Four good reasons for choosing Original Media as your Supplier, Post add £3.50 per order.

1 No Minimum Order.

2 Access and Visa accepted



3 Next Day Delivery (If order placed before 12.00 a.m.)

4 Free Helpful Advice

Next Day Courier £8.95

CORPORATE,  
EDUCATION &  
TRADE ENQUIRIES  
WELCOME.

THE ORIGINAL

**MEDIA**

COMPANY LTD.

TEL: (0530) 813591 (8 LINES)

Fax: 0530 813595

Dept NCE  
14 ASHBY RD  
COALVILLE  
LEICESTER  
LE6 2LA

PHONE  
Blandford  
(0258) 451347

**BUILD IT YOURSELF!**

FAX  
(0258)  
456046

## MOTHERBOARDS

**XT TURBO** 12MHz, V20,  
Small size, takes 256k x 4 DIL.  
£62.10

**AT TURBO**  
12MHz, baby size up to  
4M on board. £158.00

**AT TURBO** 16MHz version  
£205.00

**AT TURBO**  
with EMS 12MHz, up to 5Mb on  
board. £188.00

**386SX ALL-IN-ONE.** 16MHz  
includes floppy, serial and parallel  
ports. Takes 1M x 1 £399.00

Memory is available for all these  
boards. Please call for current prices

## CASES AND PSUS

**XT/AT**  
Three 5.25" and 3.5"  
slots or disks, flip top lid £44.50

Suitable 180W PSU £44.85

**DE-LUXE.** With speed  
display £65.00

Suitable 200W PSU £69.00

**MINI TOWER** with  
speed display £72.50

Suitable 200W PSU £69.00

## I/O ADAPTORS

**SERIAL RS232** £16.10

**DUAL RS232** £24.10

**SERIAL/PARALLEL/GAME**  
Com 1, 2, 3, 4, Par 2, 3 Links £14.50

**DUAL SERIAL + PAR**  
+ GAME £25.00

**XT SERIAL/PARALLEL/  
CLOCK/FLOPPY/GAME** £31.50

## KEYBOARDS

101 Key XT/AT switch £46.00

101 CHERRY XT/AT £65.50

## PC-DIY BOOK

If you are not sure how to go  
about building your own PC,  
then this is for you! 112 pages  
full of practical tips for £7.95  
inclusive. (NO VAT)

## DISPLAY ADAPTORS

**HERCULES** plus printer £39.20

**DUAL CGA/HERC** £38.00

**EGA PLUS** £99.50

**VGA 8 bit** £99.00

**UNIVERSAL VGA** 8/16 bit VGA,  
EGA, CGA, MDA, Hercules.

Standard plus 800 x 600 plus  
1024 x 768 resolution £137.00

## MONITORS

**MONO 12" green** £73.00

**VGA 14" paper white** £165.60

**VGA 14" colour** £389.00

## FLOPPY DRIVES

5.25" 360K..... £66.70

5.25" 1.2M..... £80.50

3.5" 720K..... £71.76

3.5" 1.44M..... £85.56

5.25" cradle for 3.5" drive  
adaptor and cables..... £12.50

## DISK CONTROLLERS

## UNIVERSAL FLOPPY

DRIVES 380/1.2/720/1.44 drive  
AT and 386 systems..... £24.50

XT Hard/Floppy controller. £81.00

XT Hard disk controller..... £65.00

AT floppy/hard controller. £107.00

"SKELETON"  
SYSTEMS

These consist of motherboard,  
case and PSU. You add the rest!

XT 12MHz..... £155

AT 12MHz..... £250

AT 16MHz..... £305

## BLACKMORE ELECTRONICS LTD

Unit 14A, Sunrise Business Park, Blandford Forum,  
Dorset DT11 8ST. Telephone Blandford (0258) 451347  
WE TAKE ACCESS, VISA AND AMERICAN EXPRESS.



## ◆ FOR SALE

**ATARI 520 PM ST.** Lots of games, mouse, etc. £250 ono. Quick sale. Tel: 0284 767459 after 9pm.

**1 MEG AMIGA** Vortex 40 MB hard drive, penpal, maxiplan, page setter II. £600 ono. Phone 021 308 8188 after 7pm.

**C64 SOFTWARE** on cassette. 100's of titles. S.a.e. for lists. Michael Vainola, 5 Woodside Cottages, Highwood, Chelmsford, Essex CM1 3RD.

**APPLE MACINTOSH SE**, 4 MB RAM, 40MB hard disk, games, utilities, magazines, excellent condition. £1,700 ono. 0375 851706.

**ATARI STM** and external disk drive software, sound sampler. Tel: 0460 67190. £200 ono.

**FUJI 35 Meg** Hard disk ST to SCSI interface and power supply also 3.5" double sided disk drive. Offer. 0582 602722.

**AMIGA 1081** colour VDU £150 ono. Tel 0935 72290 and ask for Rob. Please leave name and number if I'm absent.

## MODEMS! MODEMS! MODEMS!

Large stocks of major brands available at realistic prices  
Technical advice a pleasure!

**V22 (1200 baud) Hayes compatible from £75**  
**V22bis (2400 baud) Hayes compatible from £90**  
Fax cards from £100

All modems tested, guaranteed & BAPT approved

**Supply Solutions: 081-566-3639. Phone till 8pm Monday & Tuesday**

**AMSTRAD CPC** instant word processing rombox with Protex and Prospell plus manuals. £40. Tel (0794) 516911.

**ST MAGAZINES** for sale. ST User July 87-Dec 90, ST World Feb 88-October 89. Also a selection of A.C.E. and ST Action. Any offers? Buyer collects. Tel: 0404 44069.

**PC XT AST** memory cards, populated 1.8MB £160. ZMB £170. Alloy tape streamer £120. PC-MOD EM £80. Tel. 0252 875438.

**NINTENDO** for sale with 4 games. All boxed, in good condition. £100 ono. Contact Anthony on 0532 311186.

**TWO SPECTRUMS.** £800 of hard + software. Bargain at £150 or swap for a SAM. Phone Farnborough, Hampshire (0252) 547911.

**ATARI 520 STFM** fourteen months old. £700+ software, external drive, joysticks, mouse, lot of magazines with disks. Mint condition. £330.

**SEGA MASTER** system, light gun, etc., 17 games. Also C64 data recorder, etc. Loads of games. Offers. Tel: 0937 835164

**PRINTER** paper 2000 x 70 G.S.M. No vert perms. £5. Buyer collects. 9.25" x 12" A501 MEM EXP. £45. (0703) 676949 after 7 p.m.

**SHADOW** of the Beast for sale. Contact me. Price negotiable. Computer is Amiga 500. Game is an original without T-shirt.

**AMIGA** software for sale: X copy II, Starglider, Starglider 2, Elite, F-29, Precious Metal, Interceptor, Buggy Boy, Virus. All £5 incl. postage. Phone Dorian on (031) 557 8406.

**AMIGA** software for sale: Fantavision, Sound Trap III £20. Devpac 1, Aegis Images £5. Also books. Phone Dorian (031) 557 8406.

**AMSTRAD 6128** colour monitor over £250 worth of games worth £650. Sell for £400 ono. Phone Tunbridge Wells 544796.

**BBC-B** with 40 track disk drive. Educational software, games, magazines. Great condition. £195. Tel: (0302) 744246.

**PC ENGINE** machine and PC engine games. Lots of extras. £330. Mega drive games wanted. Will pay/swap. Mega drive, 11 games, £400. Phone 081 200 9628 after 5pm.

**MEGADRIVE** 11 games £400. Will swap/buy games. PC engine 13 games, 2 joysticks, AC adaptor multitap, £330. Philips 8833 monitor also for sale. Phone 082 200 9628 after 5pm.

**AMIGA A500** 1 Meg, second drive, colour printer, modem, mastersound, all leads, ribbons, paper, disks, software, over £160 of books and magazines, etc. £750 ovno. Tel: Becches (Suffolk) 717566.

## AMIGA DIGITIZING SERVICES

Your pictures digitized in any Amiga resolution and returned on a free disk!

Digitizing costs are £1.30 for each colour picture, and £1.00 for B/W

Please make cheques/P.Os payable to A.D.S or telephone **0903-210279**

to discuss your individual requirements

**7 Park Crescent, Worthing, West Sussex**

**EPSON HX-20** portable, built in printer + cassette. Memory expansion PSU & manuals. £100 ono. Phone 071-402 6279 ev.

**SPECTRUM** light pen, speech synthesiser, Tasword, Red Arrows, Gremlins, DTransform cartridge, £5 each Spectrum plus upgrade £20 Microdrive £20 (new). Phone Kyle 081 337 1834.

**IBMPC** software, Off-shore Ninja, Jump Jet, Ace 2, Able wordprocessor. All £5 each. Tel: Kyle 081-337 1834.

**C64C**, disk and cassette drive. Lots of equipment. Over 200 games!! Brilliant condition! Sell for £250. (043871) 7973.

**SOUND EXPRESS** Midi sampler for the Amiga. Duplicated birthday gift. Bargain at £20 ono. Brand new with receipt. Tel: 0273 512339.

**AMIGA B2000** 5 Megs RAM at Bridgeboard 20Mb PC/Amiga harddisk 2 x 3 1/2" + 1 x 5 1/4" drives LC10 Multi printer + software £1500. Norwich 621017 any time:

**AMSTRAD CPC 464**, color monitor, tape unit, games, manuals and a plug! Ideal first. £170. Lee, on 074 816230.

**AMSTRAD CPC 464**, original software - tapes, 90 tapes, SAE - lists, 1 New Cottage, Cutend Road, Fishtoft, Boston, Lincs, PE22 0QZ.

## KYC DISKS

Once only bargain offer!

★ DISCS 39p ★

Disc Drives...£60.00

1/2 Meg Amiga A500 at...£45.00 (Postage & Packing £2.85)

Amiga + ST software on offer

Screen Gems at £359 Disk Drives at £65

Posso Boxes at £15.95

All prices include VAT

Open 7 days a week!!! Cheques & Postal Orders accepted



**KYC DISKS**

51 Barmouth Road,

Wandsworth, London, SW18 2DT

Telephone: (081) 870 0469 Mobile: (0860) 763 576



**CHEAP!** S/S working drive £15. 30 originals for only £5 each: Bmoney, 3 DPool, DMaster, Populus. Tony 0590 683245 (Atari ST).

**MULTI-FACE ST!** Fully working. Still under guarantee. Comes with organiser. £20 ono. Tony 0590 683245 (after 5pm).

**COMMODORE C16** complete with datacorder, etc. £25. Toshiba MSX HX10 £25 ono, both incl. book and soft. (0280) 817376.

**SEGA GAMES** - Swap, Buy/Sell. Contact Phill, 2 Ellacombe Road, Coventry, CV2 1BP. Tel: 0203 621007 - any time.

**SPECTRUM + 3** software for sale. Masterfile + 3, Tasword + 3, Tascalc + 3, Tasprint + 3. All complete with manuals. £30. Tel: 0506 855247.

**FOR SALE** Amiga original software, GFA basic, power basic, KDATA and more. Tel: 0294 67086.

**AMIGA A500** + 1084S monitor + 2nd drive + 1/2 MCG expansion loads of software and books all boxed in v. good condition. £400 ono. Mike (0793) 814665.

**MIDI** keyboard-Casio HT700 stereo. Ideal first keyboard. £60 ono. Call 0732 351814 evenings.

**SPECTRUM + 3**, 26 disk games, 47 tape games, joystick, dust cover, mags. Bournemouth area only. £125. No offers. Tel: 603588.

**LYNX** console plus four games, including Gauntlet. Quick sale needed. May deliver within South West area. £150 ono. Tel. Jon on 0272 352844 after 6pm.

**CVLS** Phone Sheffield 0742 884183 open until 11.00pm

**3.5" DSDD 1.0 meg disks 39 pence each**  
**5.25" DSDD Coloured disks 29 pence each**  
postage & packing 7 pence per disk to a maximum of £3.50 postage

Cheques/P.O to **CVLS**, 92 Firtree Est, Thurgoland, Sheffield S30 7BG.

## SPECIAL BULK DISK OFFERS

## Bulk Packed Disks

	3.5" DS/DD	5.25" DS/DD
25	£11.90	£6.30
50	£22.44	£11.88
100	£42.16	£22.32

## Standard Packed Disks (Box 10)

High Density Disks also available on request

	3.5" DS/DD	5.25" DS/DD
1-4	£6.02	£3.44
5-9	£5.87	£3.35
10+	£5.72	£3.27

All disks include label kits and are 100% error free, guaranteed for life. Branded disks available on request. Also printer ribbons, data cartridges, paper etc. Agents for Canon consumable products and Deanes computer office furniture Agents for Imagineering, promoting the Ultra PC range VAT and delivery not included. Prices subject to change without notice.

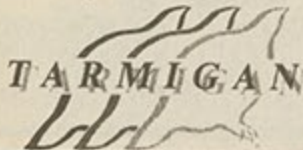

Education & trade enquiries welcome

Telephone: 0245 324976

**PANASONIC** KX-P1081 Dot matrix printer. Under year old. £95. Tel: (0903) 42387.

**FOR SALE** CPC 464 with green monitor and TV modulator with games. Tel Paul 0294 67086.

**AMSTRAD 464** clock and radio TV Tuner loads of games, robocop, Double Dragon, Under guarantee, Will sell £450. Phone 0734 576055.

**BBC Master 128.** Colour monitor. Cumana 5 1/4" 40/80 track disk drive. Data cassette recorder. Little used. £420. Basingstoke 781408.

**STAR 24/10** Multifont 24 pin printer. Still under guarantee. Rarely used. Original packing.

**FREE ST** Public Domain catalogue on disk. Send s.a.e. to K. Colbeck, 18 The Park, Southowram, Halifax HX3 9QY.

**AMIGA 500** Phillips CM8 833 Stereo colour monitor, 2nd disk drive, manuals, disks, etc. 3 months old. £450 ono. Tel 0405 813586.

**TRUST** Public Domain library for ST/E for free disk catalogue. Tel 0422 341606 or send s.a.e. to 18 The Park, Southowram, Halifax HX3 9QY.

**SPECTRUM +2,** Opus disk drive, HR5 printer, joystick, books, games, etc. Ideal for beginner or youngster. £200. Tel 081-561 2993.

**ORIGINAL** Amiga software incl. handbooks and packing. DMusic. £30. DPA INT3 £20. DVIDEO 3 £30. SONIX £30. Tel: 0709 815471.

**SHARP** MZ80K complete system including disk drives, printer, interface box with three cards, mono monitor. £120. 0302 350175.

**AMSTRAD PC 1640** EGA display, single drive, 30 meg harddisk, GEM + PC dogs software + games, mouse. £800 ono. (0788) 577368.

**SPECTRUM + 2** £2000. Software - 2 joysticks, magazines, etc. Sell for £500 ono. May split. (0255) 860423 (Essex).

**ATARI 520STE** one Meg RAM power pack, blank disks, disk case, mouse mat, dust cover. £330 ono. Amstrad 3250 DI printer. £150 ono. 0628 31224.

**COMMODORE 128/64, C2N,** 1570 disk drive, freeze frame, light fantastic kit, £200 incl. 10 games. Chester (0244) 851066.

**ATARI 520 ST** for sale mouse, joystick, games, demos & PD etc worth £1000+. \$300 ono. Tel. (0606) 46769.

**AMSTRAD CPC6128** Stop Press & mouse £30. Rainbird Advance Music System £25. KDS 8Bit Printer Port £10. Phone 0795-471956 after 7pm.

**EPSON RX-80** printer for sale. Dot matrix, parallel interface. Very good condition. £70 ono. Tel: 021-475-4034.

**AMSTRAD SM2400,** 3 months old, 7 months warranty left. James O'Hara 0674-73796. 150 pounds ono.

**AMERICAN** football statistic keeper and predictor. Follow your team's progress or try to beat the Bookie. Phone 071-266-2250 for details.

**FULL** price and budget games. Prices from 50p to £3 (or swap for +3 compatible printer.) Send for lists. All in mint condition -Spectrum.

**SPECTRUM** games for sale. Please send s.a.e. to 203 Long Lane, Bolton, Lancs BL2 6EX or phone (0204) 23357 (for list).

**C16** originals. Over one hundred boxed. Send s.a.e. or buy the lot for £50 + p&p. 44 Elm Park, Clonmel, Co. Tipp. Eire.

**42MB** ST hard disk with gesoft host adaptor. Metal case. Perfect. Any test. £300. Tel: 081-889-427. Tottenham.

**BBC Master 128.** Microvitec monitor. Cumana 5 1/4" 40/80 track disk drive. Data cassette recorder. Little used. £420. Basingstoke 781408.

**APPLE** Two computers. One for spares. £150 or swap for Sinclair C5 Tel: 042-524840.

**ATARI 800 XL** with data recorder. Power supply. Some games. £40. Also Commodore Pet 8050 dual disk drive with s'ware £15. Kirdford (040377) 545 W Sussex

**COMMODORE 64** cassette, joystick. £300 worth of software, reset cartridge, lots of programming books. All this for £100 ono. Tel (02080) 815970 after 5.00pm.

**AMIGA** Second Drive £40 or swap ST equivalent, Amiga Action Replay £40, Amos £25, Ruby Comms £30. Call Glenn 0932-567614 eves.

**BBC Model 'B',** old but working fine. 5.25" disk drive plus various games £120. Phone 0433-50574 (Sheffield)

**PRINTER** 9 Pin Dot Matrix. Commodore. Mint condition £90 ono. Games. Boxed originals. Starglider, Karate Kid, Defender of the Crown, £5 each. Phone (0474) 854532

**TAXAN 12"** Colour Monitor Model Visionex RGB/Comp. lead for Amiga included £75.00 buyer collects. (B'ham area) 021-351-2783.

**HEWLETT Packard 33E** Scientific Programmable Calculator PSO manuals £30. Phone 041-551-0320 after 7pm.

**MUSIC X.** Unused gift not wanted for Amiga. £65 ono. Tel: 0274-574187 (Brian) Also 1/2meg upgrade £40. For Amiga.

I have a Commodore 16 in good order, complete with over £50 worth of games, plus manual etc and a programming book and a joystick, tape recorder. £60. No offers please!

**SPECTRUM** games, utilities and hardware for sale (cheap!) Write to A. Murdoch, 88 Woodland Rd, Woodchurch, Birkenhead, Merseyside L49 8HW or Telephone 051-678-7501 for list!

**BBC Issue 7.** Boxed as new £175. Also various Beeb accessories going cheap, including digitizer. Ring 0604-401305.

**BBC model B DFS 40/80** double drive Microvitec monitor teletext mouse, loads of books and software, ROMS etc - £395. No offers 051-430-6488

**SEGA** System joysticks and games worth over £500. All boxed, 9 months old, good condition, all new games. Will sell for £250. Bargain. Phone 0272-793497

**SEGA** Master System with light phaser, joystick, joypads and games worth over £500. Bargain only £250. All boxed and in excellent condition. 0272-793497

**LOTUS** Symphony nearly new, in perfect condition, worth £550 new, will accept £250 ono. Please call 0252-712949 after 6pm

**AMIGA** Stuff Jinxter, Interceptor, Barbarian II, all boxed £5 each. A501 Memory Exp. £45. The real thing. (0703) 676949

**AMIGA 500** 1.3 DOS as new with modulator £285. Ring 0604-401305.

**ATARI STFM** contrivor mouse, joystick and £200 worth of software for £159.00 ono. Contact Michael after 5pm any night of this week on (0494) 464058.

**GAMES** for Atari ST, Carrier Command, Starglider 2, Robocop, plus 15 others £15 the lot. 15 Amwell Rd, Cambridge, Cambs. Ask for Chris

## ISLAND DIGITAL

## MIDI MUSIC SPECIALISTS

MUSIC HARDWARE	MUSIC SOFTWARE
Cheetah Stereo 16bit sampler.....£750	Music X version 1 (Amiga).....£50
* MS6 Synthesizer Module.....£275	Vertuoso (ST).....£50
* Master 5V keyboard.....£275	Texture (IBM).....£75
* MD16 16Bit	Voietra SP3 IBM.....£295
Digital drum Machine...£275	
COMPUTER HARDWARE	
Available if purchased with any of the Music Hardware.	
Amiga Flight of Fantasy.....£345	Atari ST Discovery Pack.....£265
Atari STE Power Pack.....£345	IDS IBM Compatible PC.....£350

FOR FURTHER INFORMATION ON MUSIC SOFTWARE OR HARDWARE RING OUR MAIL ORDER HOTLINE 0705-464704

133 different original cassette games for Spectrum and C64. £1 each. Phone Simon Gibson on 0424-223933 for details.

**ACORN** Electron plus over £200 worth of games, magazines etc £80. 0734-403041.

**AMSTRAD** Magnum Lightgun plus 6 games disk/tape £20. 0734-403041.

**ATARI Lynx 4** games £160. Sega Master System 13 games £120 or swap both for PC-Engine CD-ROM or PC-Engine games or Amiga. Tel: (0222) 489033

**AMSTRAD CPC464** plus monitor. Excellent condition with over £550 worth of original games inc. Robocop, R-Type and Op.Wolf plus phasergun bargain £250 ono. Tel 021-772-6327

**AMIGA 500,** 1-Meg, Ext. Drive, 14" Sony Trinitron, 130 discs, 90 magazines, joysticks, manuals V.G.C. £700 ono. 035455480 (Cambs)

**AMSTRAD 1640** PC ECD 32 Meg Hard Card Double Disk Drive complete with Dataease Lotus Fleet St etc. Excellent value £850, quick sale price.

**SEGA** Megadrive with 12 games inc Thunderforce 3+2, Super Shinobi, Golden Axe, Phantasy, Star 2, £60. (Jez) 081-965-1699.

**ATARI 800XL** 1050 disk drive datacorder PD, games, mini office £120 Miracom W54000 Modem + Comms software £80. Call Mark 081-942-7278.

**ATARI** Portfolio card drive bought by mistake, still boxed, sell £40. Tel 081-478-7868 after 6pm.

**COMPUTER REPAIRS**

★ FREE ESTIMATES ★ 12 MONTHS WARRANTY ★  
Amstrad, Atari, Commodore.  
Monitors & Printers, Amiga & ST Specialists  
Fixed labour charge + parts & carriage  
★ STFM POWER SUPPLY REPAIRED £30 ALL INC. ★

**COMPUTER SPARES**

Parts & Service Manuals for  
Acorn, Amstrad, Atari, Commodore, Sinclair  
& most makes of Monitors & Printers  
All services & goods supplied subject to our terms of trade

**GJS COMPUTER SERVICES**

37 Bamford Street, Clayton, Manchester, M11 4FE  
(Callers by appointment only)  
Tel: 061 231 6608 Fax: 061 223 7531

**PSION II** Organiser Model CM including 32K memory upgrade, brand new unwanted gift, £80 ono. Tel Mark on 0860-586513

**UPGRADE** forces sale. BBC 13 CPC6128, lots of extras, books, ROMs etc. All sensible offers considered. Genuine enquiries only please telephone Phil 091-2684345 after 7.00pm please

**SPECTRUM +2** computer, 2 joysticks, mouse, multiface, light pen and software. Games, worth over £600. Only £400.

**AMIGA PD** over 370 titles available, send stamp to: New World PD, 51 Heritage Drive, Gillingham, Kent.

**AMIGA** educational software - Robot Reader Talking Storybook £6, Fschool2 6-8yrs £6. Datel S/Express 2 £20. Phone 0492-44341.

**SPECTRUM +3** with MF3, mouse and a host of utility software £125. Phone 091-2372329 after 2.30pm.

**SHAREWARE/PUBLIC** domain for the IBM PC. 300+ titles available. Tel 0533-713867 for details.

**C64** Flight of Fantasy 1yr, boxed. 50+ original games - Robocop, Myth, Untouchables etc £90, 043350574 (Sheffield).

**LOTS** Spectrum games, most 75p, some £1.50. A Jones, 2 Townmead, Oakford, Devon EX16 9EW. Call (03985) 438.

**AMIGA 500**, 2 Meg Memory, A590 hard disk, external drive, mono monitor. All for £600. Phone 081-9024310 after 6pm.

**ATARI 520STM** 1 Meg Memory Twin 1 Meg Drives, Mono Monitor, Citizen 120D printer, all for £400, phone 081-9024310 eves and weekends.

**ACORN** Electron, joystick, interface and software £70 ono. Phone 0922-35515.

**PC/Compatible/640K/3 1/2 - 5 1/4** Drives/32 Meg/8087 - Fitted/EGA Monitor 14" Colour/Epson Printer/Mouse/64K Buffer/£800. 061-633-08 24.

**AMIGA** Graphology program (handwriting analyser) original with manual, great fun, very impressive £20 ono, phone anytime (0474) 854532 (Also for sale original games and 9 pin printer.

**EPSON** P80 battery/mains thermal printer C/W charger and mains adaptor. As new £175 or swap for Star LC10. Yvonne 0985-213665

**MATHS** Co-pro Intel 80 287-8MHZ. Free installation 20m radius or securicor delivery £75 (0923) 39529

**ARCHIMEDES** A3000 2MB W/Colour Monitor and Star LC10 colour printer, all boxed & guaranteed 100+ discs, many more, £950, 061-973-9737

**AMIGA 500**. A501 Expansion, Amiga High-Res Colour Monitor. Mouse, manuals, joystick, 50 disks, £495. 0746-765580.

**SPECTRUM +2** 120 games, light gun, two joysticks, worth over £250, only £170 ono.

**FOR** sale for Atari ST Supercharger PC Emulator Imeg Ram £150 Hi Rez monitor £70, FSII Bristol 0272-825702.

**OPUS** PCII Zomb Hard Disk 360k 5 1/2" and 720k 3 1/2" Drives Star NL10 Printer plus loads of software plus trolley, lot £650, Tel 081-0998-2042.

**ATARI 520** STFM 1 Meg Internal Drive, £350 worth of games, external drive + Syncro Express. Quick sale £280 ono, 0322-349088, ask for Dan.

**AMSTRAD 5 1/4"** internal disk drive 360k. Never been used £75 ono. Tel 0268-41345 evenings.

**SPECTRUM** GCR-MAC emulation for the Atari includes update 2.65 manual & software £300. Tel: 051-733-0369.

**DACOM** Modem Auto Dial/Answer V21/V23 as new with ST lead & comms software £65. Tel 0532-707613. Wanted! GFA Artist for Atari ST.

**AMIGA 2000**. 1.3 Kickstart. 3.5 Drive. Excellent condition, 1st cheque over £550 securities. Wanted Amiga Kennedy Approach. 0736-752982.

**34p**

**INC. VAT & LABELS**

**3.5" DSDD INDIVIDUALLY WRAPPED DISKS**

100% certified error free + guaranteed  
Add 1p for credit card orders  
40 cap disk box: £3.99, 80 cap: £4.49  
Hi-tech 12 cap library cases £1 each  
Postage - add £2.95 per order

**Universal Overnight Distribution Ltd.**  
Enterprise Centre, Unit 26, James St, Carlisle, CA2 5BB.  
Tel: 0228 42373 ext 53. Fax: 514484

**WANTED FOR CASH**

Amstrad PC's, PCW's, Amigas, Atari ST's. Printers, Lasers, ANY QUANTITY CONSIDERED, working or not.  
**DMR ELECTRONICS: 0274 817889**

**XCAD** Professional - The ultimate CAD package for the Amiga. Mint condition. Unused. 2nd advert due to timewaster. £200. 03552-46914. Phone after 5pm.

**BBC** Model 'B' Issue 7 cassette unit, twin 40 track disk drive, games, book, joysticks, all in good nick, offers around £250. Tel: P'boro 0733-340062.

**ATARI 800XL**, Disc drive, printer IIF, C200 games, Mini Office 2, Visicalc etc £100 also Electron + S/W £35 Tel: (061) 339-6779 eves.

**CORSE** fishing outfit, all you need £350 or exchange for Amiga computer and some games, any computer considered. Tel 081-318-1782

**C64** Stuff Easyscript Manual £3, Datel Fast Hack'em £5. (0703) 676949 after 7pm

**AMIGA A500** latest V3 Kickstart, plus games, mouse and modulator, hardly used, mint condition : £300. Tel 0962-885216.

**AMSTRAD 6128** Colour Monitor, games, spreadsheet, database, etc very good condition £250 ono. Tel: 0293-560089.

**GREAT** offer! Master, Cub Monitor, 80T Drive, LC10 Printer, software, offers in the region of £450. (0702) 293451 (eve)!

**FOR** sale Computer PC200 Amstrad colour monitor, mouse, joystick, software, manuals. Still as new, £175. Tel 081-529-4211.

**ATARI 520STM** 1 Meg Memory 2 1 Meg Drives & usual extras £335. Wanted 1 Meg Simms Also 1 Meg Chps, 256k Drams (0495) 272092.

**R.S.T COMPUTER MEDIA - AMIGA SPECIALIST MAIL ORDER/HARDWARE/SOFTWARE**

0582 872754

**SPECIAL CHRISTMAS OFFER**

**1 MEG AMIGA MEGAPACK** £399 inc. VAT plus joystick  
**1084S MONITOR** £240 inc. VAT & free delivery

**FREE 24HR DELIVERY SECURICOR**

With EVERY Amiga A500: SCREEN GEMS ★ FLIGHT OF FANTASY ★ OR ★ BATPACK + JOYSTICK ★ 1 MEG OF MEMORY ★ READY FITTED & TESTED ★ ★ TV MODULATOR ★ WORKBENCH ★ MOUSE ★

SCREEN GEMS	FLIGHT OF FANTASY	BAT PACK
★ Shadow of the Beast II ★ Back to the Future II ★ Days of Thunder ★ Knightbreed ★ Deluxe Paint II	★ F29 Retaliator ★ Rainbow Island ★ Escape from the Planet of the Robot Monsters ★ Deluxe Paint II	★ Batman - The Movie ★ F-18 Interceptor ★ New Zealand Story ★ Deluxe Paint II

DISK DRIVES CUMANA 3.5 £69.00+P&P | 20 MEG Amiga A590 Hard drive £339 + P/P

**RING NOW 0582 872754 OR WRITE R.S.T COMPUTER MEDIA, 57 RIDGEWAY, KENSWORTH, BEDS LU6 3RL**

**Page Plus**

for WINDOWS

"Quality on a budget"

"Strongly resembles the DTP classic PageMaker"

"Features galore...plenty of fonts..."

NEW COMPUTER EXPRESS - ISSUE 101

PagePlus is for Windows 3.0 users wanting to do Desktop Publishing: you need an AT-compatible (286 or higher) with at least 1mb of memory, and Windows 3.0 in standard or 386 enhanced mode. Available from 26th November, PagePlus will retail at £99. Order now and get your copy for only £59!

Serif (Europe) Limited  
PO Box 15 West PDO • Nottingham NG7 2DA  
(0602) 421502

**PROTEXT & Logistix** for IBM PC 5 1/2" £30 each. I will pay postage. Mr B Hilton, 6 Walnut Walk, Polegate, E. Sussex BN26 5AD.

**AMSTRAD PC2086** dual DD mono monitor, mouse, software, hardly used, original boxes £500. Tel: 0477-35278 North Cheshire.

**AMIGA 500** 1Mb, second disk drive, control centre, Phillips 8833 colour monitor, WP spreadsheet & loads of original games £600.

**IBM CGA** monitor with adapter £120, EBM mono green monitor with adapter £80, IBM PCXT KBD £30, IBM PCXT ENH KBD(101) £55, IBM EGA adapter £50.

**MICROSOFT** word V4 on 5 1/2 disks all manuals, best offers or swap any Archimedes hardware/software. Phone Road on Cov. 367283.

**SIRIUS** PC, monitor, keyboard, manuals, software, IOMB hard disk, with SCSI. SCSI can be seen working with a ST £200, Leon 081-870-1884.

**PCAT 80286** 1 Meg 1.2 Floppy Drive 40 Meg Hard Disk High Res VGA colour MS DOS 3.3, 3 months old, private use, £1000 021-551-6719.

**520 STFM** 1 Meg Internal Drive with original boxed games 40 assorted PDD Mag discs in lockable box, loads of mags, buyer collects £280, 0246-235105.

**SPECTRUM +2 218K.** Good condition. Joystick, games, some 4-8yr educational software, £80. Tel: (0305) 832429.

**AMSTRAD PCW 9512** + printer + Locoscript, new, 3yrs warranty, bought in mistake, cost £697 accept £550. 0226-763756 South Yorks.

**ATARI 520 STFM,** Superpack, condition as new, boxed, £950 of software Xenon II, STOS, paintpot, joystick, mouse & mat, manuals, £350, 081-8581758.

**ATARI 4MB STE** 8 months old with around 300 disks, mint condition, offers + SAE to Paul, 35 Shaw Crescent, Loch Gelly, Fife, Scotland KY5 9LH.

**SPECTRUM + 2** with joystick, 30 original games & spare power supply. Original box £200. 0252-712949 after 6pm.

**GENUINE IBM PCXT,** 640k, CGA display, IOMB hard disk, 360k floppy disk, serial, parallel, £470 ono, also printer £50. Tel: 0234-857482.

**MEGA** drive, Thunder F3 £24, Batman £24, Phelios £24, Curse £22, Alex Kid £16, 081-592-2117, ask for Samir, need buyer in London area.

**ATARI STFM 1MB** Drive, 512k, joystick unformatted disks, 7 serious packages, 6 games, 28 public domain only £200. Ring Graham on 0245-350708.

## "CHIP SHOP" LTD HAVE MOVED TO:-

Unit 5, Royal Oak Trading Estate,  
Cooper Street  
off Higher Hill Gate,  
Stockport  
Cheshire SK1 3QJ

Tel (061) 476 3070

Fax (061) 476 3114

VISA

Access

**7 SPECTRUM** books on Machine Code, ROM disassembly, Comms, AI, etc worth over £45, £20 + post. Tel: 0298-26800.

**AMIGA** samples IFF many instruments, drums, FX etc. Send SAE + £1.50 to M.J. 40 Tarswood, Skelmersdale, Lancs WN8 8NX.

**MICROSOFT** works V1.05 £10.00 inc postage. Tel St Albans (0727) 837793 eves.

**20 Meg 1/2** height hard drive, £60 ono, IBM mono green antiglare monitor £20, funny old keyboard with telephone plug £5 Amiga lattace C Ver 4.1 £50 0883-717946 (Surrey) evenings.

**HEWLETT** Packard Thinkjet Printer, unused, bargain at £100, want quick sale. Tel: 081-594-4126.

**BEAT** the Xmas rush swap your Einstein 256 for my Twin Trace Oscilloscope now, for details please write to: J Smith, 41 Calder Ave, Corkickle, Whitehaven, Cumbria CA28 8AR.

**AMSTRAD PC 2086** twin drives, mouse, manuals and software, one month old £550 ono. Phone Maryport 815371.

**AMIGA** games! Gouls N Ghosts, Colorado £10 each, Ivanhoe £15, also excellent CPC games, cheap. Tel: 081-360-8770.

**FOR** sale Sam Coupe Computer includes disk drive comms interface, all cables, power pack, assorted Spectrum games, £270 ono. Phone 061-740-7907 between 12pm and 4pm, Alan.



**KAO MF2HD**  
Double sided  
1Mb capacity

**OPENING HOURS**  
Mon-Fri 9.30am-7.00pm  
Sat 9.30am-6.00pm  
Sun 10.00am-3pm

THE WORLD'S FINEST DISKS FROM T.D.K & KAO SERIOUS QUALITY FOR SERIOUS USERS

		BRANDED BOXED IN 10'S WITH LABELS	
		KAO	TDK
3.5"	MF2DD	135 tpi double sided double density	£8.00
3.5"	MF2HD	135 tpi double sided high density	£15.00
5.25"	MD2DD	96 tpi double sided double density	£5.00
5.25"	MD2HD	96 tpi double sided high density	£8.00

KAO DISKAROO DISK WALLET CONTAINING 10 BRANDED MF2DD DISKS £10.00  
KAO MF2DD BULK DISCS 8 COLOURS: BLUE, GREY, RED, YELLOW, GREEN, BLACK, ORANGE, FOG WHITE

	50	100
<b>1 MEGABYTE</b>	<b>£24.00</b>	<b>£48.00</b>
<b>2 MEGABYTE</b>	<b>£48.00</b>	<b>£95.00</b>

(PURCHASERS OF 100+ DISKS: WE WILL INCLUDE A FREE 3.5" DISK DRIVE CLEANING KIT)  
All above disks are 100% error free & warranted free from defects & as such carry a 1 for 1 guarantee  
Posso Box 3.5" + 5.25" ONLY £14.00 EACH.  
DISK BOXES 3.5" 40 cap £4, 3.5" 80 Cap £5, 5.25" 50 cap £4, 5.25" 100 cap £5  
STAR PRINTERS LC-10 Mono £150, LC-10 Colour £210, LC24-200 mono £255  
Send call/phone/fax for free price list  
NB All prices inc. VAT with FREE postage & packing on orders over £50.00. Overnight delivery £8.00 extra.

K.C. VIDEO, 6 & 8 DONCASTER ROAD, SOUTH ELSMALL,  
NR. PONTEFRAC, WEST YORKS, WF9 2YZ  
TEL: (0977) 649100 FAX: (0977) 643312



**ATARI 520 TFM** 1 Meg internal drive, 2 joysticks, mouse and over 75 games still boxed £300. Tel 0742 471242, ask for Mat/Lee.

**BBC'B' Computer,** VGC, with Cumana disk drive, data recorder, approx 50 games, joystick, manuals, £195 ono, ring 081-393-8096.

**£150** seems fair for my 1000 EX Computer with monitor and software manuals MS DOS 3-2, first come first served, postage or COD 0793-610325.

**EXPRESS 1-100** £30 inc p&p ST games: Simcity £12, WC L'Board £5. £15 the pair inc p&p. Wakefield 0924-254752.

**ATARI ST** software for sale - Outrun, Karate Kit, Quartet, etc etc. Phone for details. All boxed. Ely 0353-777637.

**AMIGA 500** + Phillips 8533 colour monitor and disk drive, manuals, joystick, disks, books, etc 3 months old £500 ono (0405-813586).

**AMIGA** software from only £5 list includes Aegis Sonix, Speedball, Moonmist etc. Phone 0705-691384 for details.

**INTEL 80287** Math Co-Processor £110. Autosketch V2 £35. Both for £135. Ring John 081-840-4417.

**NINTENDO** Gameboy, Tetris, Super Marioland, Tennis, Baseball, immaculate condition, cost £210, sell for £130. Phone 0908-583318 after 6.30pm, ask for Tarquin.

**SEGA** Games, Rastan £15, Lord of the Sword £15, Alex Kidd and the Lost Stars £12. Phone 0408-583318 after 6.30pm, ask for Tarquin.

**ST Games** including XE NON2, Kult, Dungeon Master, Interphase, from £2 - £10, send SAE to: M. Norton, Colingdale Nurses Home, Colingdale Hospital, Colingdale, London NW9.

**ATARI Lynx** Game Card for sale Gauntlet 3 £20. Write to Mr S. Law, 88 High Street, Crediton, Devon EX17 3LB.

**AMIGA 500,** 20 games Phillips Colour Monitor HRS Printer + 1 Meg expansion. Cost £1250, sell £450. Tel: 0268-691658.

**ATARI 520TFM,** two drives, magazines, joysticks, games, 40 blank disks, disk boxes, all for £280. Tel: 0942-608584.

**NAKED** CBM128 business software on disk tape includes £300 games, instruction manual, 1901 quality monitor, 1570 fast disk drive tape, leads included £300 ono. Phone 0992-589113.

**ATARI STM** 1/2 Meg and 1 Meg external drives, some software, manuals, magazines etc. Offers around £200. Phone Andy (0204) 594277 after 6pm.

**SPECTRUM** + Opus Discovery Multiface, Genie, Tapedeck, joystick + lot of games £150 or will swap for ST compatible colour monitor.



from £40.83

We support over 24,000 printer brands, and have a complete range of colour, heat-transfer (for T-Shirt printing), and indelible inks. Colour, multicolour, heat-transfer, and uninked cartridges & refills supplied - Ask for our free catalogue.

Most ribbon re-inking services use our MacInkers, and over 130,000 have been sold since 1982.

## MGA SoftCat

(0797) 226601 Fax: 226721

41 Cinque Ports St., Rye, E. Sussex TN31 7AD

(PRICES EXCLUDE VAT. & p&p extra) E.& OE

Access

VISA

## TREASURE ISLAND

1 2 3 4 5 6 7 8 9 10

A B C D E F G H I J

**CASH PRIZES**

**USE YOUR VOICE TO LOCATE THE TREASURE**

### 0898 313 586

Infodial PO Box 36 LS1 4TN Call Charges 33P Per min Cheap Rate 44P all other times

**BBC B**, remote keyboard with built in twin disk drives, lots of software ROMs books etc £200 ono. 061-707-2147.

**GAMEBOY** with Super Marioland & Tetris, headphones & extension cable only a month old. Unwanted gift £80. 0268-691658.

**COLOUR** monitor Phillips CM8833 excellent condition with Amiga lead. Cost £300 sell for £110 ono. 0268-691658.

**DON'T** look elsewhere! Atari 1520 STFM with DS drive, oodles of games, PD, all manuals etc £280. Tim 0223-351138.

**PC1640DD** PSU £300 & Monitor, Sharp PC7100 £300 or swap either for Apricot Xen. Swap Sam Coupe for HD. 0480-75036.

**ATARI 520 STFM**, many disks & magazines, Amstrad Synthesizer, VGC £390, all boxed, buyer must collect though. Tel: Newmarket 0638661377.

**ARCHIMEDES 310** Colour Monitor, Epson LX800, S/W inc 1st word+, IBM PC. Emulator, games, etc. All for £800 0933-676384.

**TANDY 200** Portable Computer, 5 built in programs, modem, manuals AC adapter, modem cable, £190 ono. 081-6408967.

**COMMODORE C64** disk drive, modem, tape deck, joystick, parallel interface £200. Please ring 081-398-5167.

**ATARI 3 1/2"** external drive (Epson SMD 300) joystick - port powered excellent condition (unused) £70. 031-346-1874.

**BBC B** with 100k floppy. RAM Expansion Board Wordwise Floppywise Quickmon £200. No offers. Warrington (0925) 831104.

**AMSTRAD CPC6128** Colour Monitor, keyboard, games, magazines and manual. Worth £400, sell for £300. Need quick sale. Phone Steve after 5pm. Harlow Essex (0279) 434191.

**AMSTRAD CPC6128** keyboard for sale. Games, mags and manual. Worth £200 sell for £100. Needs Monitor. Quick sale needed. Phone Steve after 5pm. Harlow (0279) 434191.

**C3M64 1541-11** DD mouse, joystick, Simons Basic Geos, lost of games, books, etc. All for £225. Tel: 0532-551208.

**ZX Spectrum +3**, with Datacorder, Multiface 3, 2 joysticks. £300 worth of software. Tel: Andy on 041-441-1961. £200 ono.

**SEGA Master System + Wonderboy 3** and Phantasy Star, £65. SE London please. Lucien Hoare, Penge (sorry), London. Tel: 081-778-9398.

**SEGA Megadrive** inc six games (Strider) for sale, Scart version, mint condition £280. Will separate. 021-783-8894.

**AMIGA A590 20 MB** hard disk, £250. 1084 monitor £120, AF880 disk drive £50, Star LC10 colour printer £150, 0224-824904.

**SEGA megadrive (Pal) Plus 10** games, including SMEP, Thunderforce 2 + 3, Ghoul's N Ghosts, Super Shinobi, all boxed, £360. Tel: (0785) 48940.

**COMMODORE CNT6410** modem for C64 complete with Prestel/Micronet s/ware Compunet compatible. Only £65 inc postage. Chester 0244 851066.

**BBC model B**, with Wordwise plus all manuals and software £150. Phone 0243-552631.

**PAGESETTER 2** £50 - Digiview Gold V4 £70, full size multiplay CD player (Phillips) £200. Call 0203-316420 anytime you want to, I'm not fussy really!

**ST games** Batman the Movie and Man United for sale £10 each or swap for any other good game. Phone 0382-74883, ask for Kenneth.

**AMIGA 500 1MB** Expansion Colour Monitor 2nd disk drive Star LC10 printer, mouse, joystick, sampler £800 ono.

**ATARI 520STFM** mint condition external drive, lot of software, lots of magazines & disks, joysticks, leads. Bargain at only £330.

**ATARI ST** enthusiast wishes to swap or sell PD> Massive selection available. Around 1000 disks. Phone Fraser on 031-553-2356 for details.

**AMIGA 23 pin** plugs and sockets £2-30 each. AMIGA track display (shows head location) £45. S. Barr, 16 Ogilvie Road, Stirling, FK8 2HJ.

**520STE + games** £300. Also 400 computer mags for various computers £150 or £400 the lot. Buyer to collect. Phone 0250-5781 after 6pm.

**ATARI 520 STFM** hardly used, 14 months old, external drive £700+ worth software, joysticks, mags and disks £330.

**SPECTRUM Stuff** Disciple Interface £35, Saga Elite Keyboard £35, IF1 and Microdrive £25, ZX81 £15, Pro Keyboard £15. 0432-341500.

**SPECTRUM +128k**, cassette recorder, joystick and interface, over £450 software and magazines. £120 ono. Tel: Cardiff (0222) 702941 evenings.

**QUICK** sale. 1040 STFM, VGC £250. Upgrading to STE. Phone John, Leeds (0532) 602284. Buyer collects.

**Modem 9600 HST**, Hayel compatible manual only £400. Phone 0202-872365, ask for Kester after 6pm thanks.

**AMSTRAD PCW 8256** £250 boxed, excellent cond. All manuals included. Tel: 0642 (Cleveland) 317740.

### MOUSE REPAIRS

**ATARI ST and Amiga** Mouse repairs, original or 2nd party, i.e. Contriver 820 & 830, Kempston (Not Naksha types) and Genius. All repairs by return of post.

**Standard Service:** Button switches replaced. The inside and outside of Mouse thoroughly cleaned, including the rollers, and any internal faulty components replaced. **Only £5.95 incl P+P**

**Full Service:** As the standard service but also includes the replacement of the mouse lead **Only £9.50 incl P+P**

### TRACK-IT

Uses a 2 digit LCD display to show the disk drive track number i.e. 0-85, for drive 1 or 2, selectable by front panel switch. Also shows side 0 or 1 and if the disk is write protected. Measures 28 x 65 x 120mm. Works with any model of **AMIGA OR ATARI ST** and any make of disk drive internal or external. **Only £29.95 incl P+P**

Send cheque/PO to: **Romulus Data Systems**  
56 Menzies Avenue, LAINDON WEST, ESSEX SS15 6SY (MAIL ORDER ONLY)

**CGA** card for PC/XT, full length, with 9-pin monitor port, and 25-pin printer port £15 to clear. Tel: Don 071-624-1191.

**IBM XT Turbo 10MHZ** 20Mb hard disk 640k ram twin floppy drives. For quick sale £595. Tel: (0282) 22308 after 5pm.

**SAM Coupe** £100 ono or swap for IBM Hardcard Sharp PC7100 Portable 768k swap for Amiga B 2000 or AT. 048075036.

**AMIGA** software. Penpal £50, Personal Accounts £20, Cross Dos £15, The Works £15 and others. Tel: Gravesend 327625.

**BBC/ELECTRON:** original cassette/disk games for sale. Send SAE to: Peter, 68 Donald Drive, Chadwell Heath, Romford, Essex, RM6 5DU.

**AMIGA** colour monitor, Commodore 1084 £160. Cumana ext. drive £45. Half-Meg upgrade £30. Tel: 091-5110373.

**ORIC 1** computer still in original box complete including manuals and some software £50 ono. Phone Eric 091-2365059.

**APPLE II Euro+** d.drive, monitor, carrying cases, HiDOS, printer, Eprom, expansion cards, Visicalc, DB Master, Spellchecker etc, plus manuals and some PD, £150. Phone Eric 091-2365059.

**SPECTRUM** original 48k model, good condition. Data recorder, games, revision software and all leads £30. Dunstable (0582) 660031.

**PC Engine Pal** inc gunhed, perfect condition, only £135 ono. Please ring 0403 68851 after 5pm, ask for David.

# 20% OFF RRP

## PC SOFTWARE

Aldus Pagemaker 3.0 .....	£556.00	Many more titles available at discounted prices. We can get virtually any software package discounted so please ask for details. SAE gets full price list.
Autodesk Animator .....	£159.20	
Wordperfect 5.1 .....	£340.00	
Drawperfect .....	£340.00	
Planperfect .....	£280.00	
Windows 3.0 .....	£79.00	

**BIGGER DISCOUNTS FOR BULK ORDERS** Please add £2.50 p+p per order plus 15% VAT

**PTA Software, 6b Brockley Cross, London SE4 1BE Tel: 081-692-2994**

**SPECTRUM GCR MAC** emulator for Atari ST, 128k ROMs, manual, master disks etc. £200. Mark 0272-357503 daytime, 0272-427129 evening.

**AMIGA 500** with joystick and software including Batman, Pacmania, Operation Wolf, all originals for £250. Call Linden on 081-450-8692 before 4.30pm.

**COMMODORE 710** mono, 8250P DD, 8032P printer, 102KB superbase. H/Book. £95. Cheap for sale. Buyer collects 0293-32461.

**32MB 3rd Coast** hard disk for the ST ICD utilities: £300. Phone Carl (0734) 500337 (Reading)

**AMIGA PD** for sale. Lots and cheap. Send SAE to: Jason Meachen, 59 Lee Road, Dovercourt, Harwich, Essex, C012 3SB. (No callers).

**CANNON PW1080A** black & white printer. Used on an Amiga. Good quality and robust with manual & box. VGC seen working, £105 ono. Medway 0634-863340.

**AMIGA A500 2nd disk drive** over £400 worth of software + acc. Everything in tact, under guarantee, ex. condition, £350. Stu, 7 Albemarle Rd, St Ives, Hunts PE17 6UN.

**AMIGA A500 one Meg** with Phillips monitor printer and second drive turbo silver bargain £600 081-3189290.

**MEG drive, Pal/scart, joystick,** 6 games inc. Batman. 1 month old, under guarantee as mint. Looking for buyer in London area. £300. Phone 081-5922117.

**£150 gets you Yamaha PSS680** Midi Synth + Sonix + MRS Sequencer (Amiga originals). Call Steve: NCH (0603) 429313.

**APPLE 11e & 80 Col Card** £100, hard disk & tape streamer £185, Apple 11ev+ £25, modem £30, disk drive £35, many other bits. Please enquire 0935-72490.

**FOUR track recording studio** HI FI all in one comes complete with 4 microphones, was £400, will accept £300. Contact Paul (0744) 21394.

**ATARI 520 ST(E)** with Epson printer, games, joysticks, mouse, manuals and books. Bargain at £350. Phone 0761-35180 and ask for James.

**MICRODRIVE** cartridges (45) £1-50p each. ZX printer paper 5 rolls £12. Curruh Speach £10 last Ninja Z, Driller 48k Spectrum £6 each. Phone after 6pm.

**ATARI 520 STFM one M/B drive,** external one M/B drive, lots of software, two joysticks, loads of mags with cover discs £330.

**ARCHIMEDES 410\1** excellent condition, plus software (interdictor). Still in original box, with RGB colour monitor £900. Tel: 051-342-3415.

**ATARI STFM520,** plus games worth £700: £290. Epson 24-pin LQ500: £170. SM124 Mono Monitor: £70. Original packaging, excellent condition. Phone Carl (0734) 500337 (Reading).

## ◆ Goods wanted

**AMIGA 500 (1.3)** I have £250 to spend. Also Music X. 0643-707404 after 6pm.

**WANTED EGA colour 14"** monitor for AT compatible. Must be good condition. 0253-891517 (Blackpool).

**SWAP 1 Meg Amiga external drive** for same to suit Atari ST. Must be double sided 82 tracks or more. Call Glenn on 0932-567614 Eves.

**WANTED Action Replay Cartridge,** latest one or any expert cartridge. Tel: Tyneside 091-2634866.

**WANTED ST + extra drive,** and back-up device e.g. Happy Discovery Cart, Syncro Express, swap my Amiga, HIFI, and loadsa games. Tel: (0254) 53195 evenings.

**MP/M2 disk wanted** for Rair Black Box. To replace copy damaged by faulty disk drive. Phone 0602390704 (Nottm).

# Computallations

**COMPUTER CALL-OUT SERVICE**  
(BIRMINGHAM ONLY)

**DESKTOP PUBLISHING**

**LASER PRINTING**

(PROVIDE DTP/WP FILES ON DISK. MOST DTP/WP SUPPORTED)

**DISK TRANSFER**

(5.25" > 3.5" AND VICE VERSA 1 OFF OR BULK)

WRITE FOR INFORMATION TO THE BELOW ADDRESS  
**COMPUTALLATIONS**

**2 TWYNING ROAD, STIRCHLEY, BIRMINGHAM. B30 2XY**

**ROBOSPHERE** original, arcade game for the Amiga. Only £3. Cheques to M. Sreeves, 16 Calder Walk, Leamington CV31 1SA.

**LYNX** for sale + 4 games inc Electrocop + Cal games. 3 mths old, only £165. Tel: 0202 872365, ask for Kester.

**C64C,** Load-it, Datasette, mouse, joystick, over £400 worth of software, Sell £200 ono. Tel: Waseem after 4.30pm (0706) 44300.

**C64,** diskdrive, tape recorder, joystick, manuals, spare disks, good quality software, quick sale £180 ono. Phone (after 6pm) 0268-541695.

**CBM64/VIC 20** graphic printer - hardly used £55. Original BBC games (Saigon, Winter Olympiad etc) £4 each. Phone E. London (081) 472-3383 after 4pm. Ask for Trevor.

**DIE** Hard for IBM PC on 3.5 and 5.25 inch disks. Unwanted prize, I haven't got a PC! Unopened still in wrapped £10. Tel: 092-575-4175.

**COMMODORE 710** monitor 8250PDD. 8032P printer. Superbase. Handbook. £95. Quick sale. Tel: 0293-32461.

**GAMES!** For Amstrad cassette. Worth over £370! Good stuff like Rainbow Islands, Strider, Cont. Circus, Rick Dang, Batman, OP. Wolf, Indy Jones, NZ Story, G'N'G 2! Sell for £175! ono. 081-360-8770.

**SAITEK** Simultano Chess Computer rated approx 1800, plays eight games at once, incorporates LCD Chess Board £200. New. Will accept £125.

**SHINOBI** arcade machine for sale for home or arcade use, £495. Tel: 0254-56029.

## PLATYPUS PRODUCTS

Present the **ULTIMATE** Computer Accessory.

**3.5" DISK CLOCK**

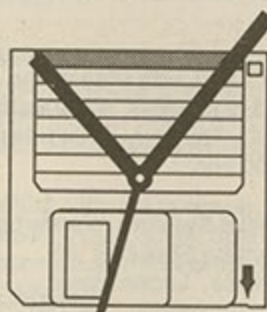

Registered Design Applied for.

**£7.50**  
+ 50p P&P

A genuine 3.5 inch disk with battery operated quartz clock movement. Each disk has different coloured Hour, Minute and Second hands, and is supplied complete with label! Requires one 1.5 volt battery.

Goods normally despatched within 24 hours.  
Full money back refund if not delighted!

Please make cheques payable to: **PLATYPUS PRODUCTS.**

**Billy The Platypus, Platypus Products,**  
**84 Hopparden Road, Tonbridge, KENT, TN10 4QU**

**METAWINDOW** for C and Pascal, original package, latest version, cost £170, sale £100 or exchange C tools, library etc. Contact Gary 071-272-8436.

**IBM PC** games for sale. 20 originals in good condition. Will split. Phone Jon on 081-809-6068.

**SAM Coupe,** 256k, disk drive, Lerm Tape 2, Defending, plus three other Sam games. Lots of Speccy games. Boxed with manuals £210 ono.

**ATARI, 520, STFM,** one M/B drive, external one M/B drive, software - joysticks, loads of mags and cover discs, £330. Tel: 051-608-9761.

**ST** games for sale. Old and new. Games include Populous, Starglider, Zet C. Phone for prices or I will swap for Lattice CV5. Phone Stuart (0737) 554536.

**WANTED RS232** Interface for the C64 + leads + modem - must be very cheap, max £20 or swap my C64 games for them. Ring Steve 0322-59170.

**WANTED** for C64 disk "Flight Simulator 11". Must have manual. Chris 0293-542395.

**CITIZEN** Swift 24 Pin Printer, preferably with colour kit. Must be in good condition. Good price paid. 0526-43587.

**AMSTRAD PC1640 HD20 & PCECD** screen wanted desperately! Good price paid. Contact Mike on 0752-785134 (after 6pm).

**WANTED** computers for free. Tel: 0422 244923 or write Free Computers, 83 Watkinson Rd, Illingworth, Halifax, W. Yorks. HX2 9DA.

## DISKS

A limited opportunity to purchase certified disks at wholesale prices.

3 1/2" DSDD Disks @ 29p Each  
3 1/2" DSHD Disks @ 59p Each

MINIMUM QUANTITY 50 DISKS

100% error free, sealed & certified

Phone David Jones 081-986 7616

**SPECTRUM** Wafadrive, need instructions config tape to photostat, buy also Wafas & Spectralwriter on Wafa. Any useful information. Tel: 0223-249865.

**WANTED:** Star LC10 Colour, Cumana 2nd drive, monitor Phillips CM8833, reasonable prices only. Phone 0202-872365, ask for Kester.

**ST** Decision in the Desert by Microprose wanted. Will pay up to £15. Phone 051-645-2997 after 4pm. Ask for William.

**WANTED** Victor Vicki PC with software and manuals. Good condition only. Reasonable price paid. Also extra software wanted. 051-605-0410.

**WANTED** TI99 games modules. Call Les on 0245 72572.

**AMIGA** P.D. utilities, etc., wanted for Kawai K4 synth. music-X, MIDI. Please phone Steve 071-383-4562.

**EXCHANGE** my Amiga A500, amp & speakers, joysticks, software and cash for C64C, monitor, drive, A4 size printer, etc. Phil, Claremont, Searle Street, Crediton, Devon EX1 2DB.

**AMSTRAD** PCW9512 with printer and spellcheck. North Yorks area preferred. Tel: 0723 354317.

**COMPAQ** DOS V3.31 wanted + info. Please tel. Anthony Clarke (0727) 837793 eves.

**WANTED**



**DEAD OR ALIVE**

**USE YOUR VOICE TO OUTDRAW THE GUNFIGHTER**

**CASH PRIZES**

**0898 31 35 94**

INFODIAL POBox 36 LS1 4TN Call charges 33p Per Min Cheap 44p Per Min All Other Times

**SAM COUPE AND SPECTRUM MAGAZINE!** PROGRAMS, UTILITIES, INFO IDEAS! NEWS, REVIEWS AND HOMEGROWN SOFTWARE MONTHLY SINCE 1987! **"OUTLET"** GRAPHICS, AND HELP PAGES, SERIOUS SOFTWARE SPECIAL OFFER! Latest issue £2.50 to newcomers on:- +3, DISCIPLE/+D, MICRODRIVE, OPUS, TAPE, SAM DISC OR TAPE **CHEZRON SOFTWARE, 605 LOUGHBOROUGH RD., BIRSTALL, LEICESTER LE4 4NJ**

**HIGH QUALITY AND PERFORMANCE 486 AND 386 MOTHERBOARDS**

AT/386/25 MHz OK.....£450  
 AT/386/33 MHz OK Cache .....£725  
 AT/486/25 MHz OK Cache .....£1600

**VGA available on request. 12 months warranty and telephone support. (Prices exclusive of VAT and carriage)**

**BRITEC LTD**

**26 Avon Road, West Moors, Dorset, BH22 0EG  
 TEL: (0202) 873421 FAX: (0202) 873421**

**ALL COMPUTER HARDWARE AND SOFTWARE WANTED FOR CASH OR EXCHANGE**

**NOTHING REFUSED!!  
 071 727 0424**

**ROM CART.** games for M.S.X. 64K. e.g. Nemesis, Turmoil, etc. Good price paid if in mint condition. Ask for Dave on 0949 831206.

**ATARI LYNX** or C128 outfit wanted. Swap for superb Casio CZ-101 synth. Tel. Bolton (0204) 492881. Caller collects.

**EINSTEIN SYSTEMS DISK**, any other utilities for sale/swap. Assembly language course, complete package (Glentop). Tel: 0325 310603.

**ANY NON WORKING Atari** ST/M/FM/E/Mega, any condition, any age. Also wanted 1 Meg SIMMS/RAMS. 0495 272092.

**WANTED:** Apple II plus contacts. I know you're out there so get in touch. Call Paul on (091) 2970541 weekdays after six.

**THE AMIGA helpline** is free. Send a stamped SAE to Gordon Keenan, 21 Skirsa Place, Glasgow G23 5EE. (The best for new owners!).

**SOFTWARE**, mainly platforms, games and shoot them ups. Must be extremely cheap. Contact Neil at 9 Hill Street, Essington, Wolverhampton, West Midlands WVH 2BW.

**READ** Newtype T.M.P. magazine?? I love it!! Chris Jackman, 3 Albion Terrace, Lexham Road, Litcham, Kings Lynn, Norfolk, PE32 2QQ.

**MONITOR** wanted for an Amstrad 1640. Either colour/enhanced. 18 Corfe Avenue, Harrow, Middlesex HA2 8SZ. 081-4234797 eves.

**WANTED** Mega ST keyboard. Good price paid, also for sale Contriver mouse, boxed as new, £10. Tel: Chris 0272-781178.

**PHILIPS** CM833 monitor wanted or similar. Will pay £100 depending on condition. Phone 0404/44069 after 6 p.m.

**BBS PROJECT** for deaf, lonely, housebound. Need P.C. modem, printer, etc. Working/faulty. Limited funds. 11 Tremaine Gardens, Wolverhampton, WV10 0AP.

**WANTED** desperately! 2400 BAUD modem for use with Amiga. Must include leads, etc. For around £90-£120. Write to: Richard Burman, 41 Pinner Park Gardens, Harrow, Middlesex HA2 6LQ.

**TASWORD** wanted for Spectrum +3 disk only. Please call 0273 600359.

**PASCAL** and C Compilers also CP/M for Spectrum +3. Write to Stelios, 96 Colin Gardens, London NW9 6ER.

**SPECCY** owner badly needs CM8833 monitor and lead. Will swap for £147 worth games. Write to S A Bernard, 66 Cardinals Way, Archway, London N19 3UY.

**SEND QUALITY PD** to Ashley Tarver, 5 Saunders House, Binswood Avenue, Leamington Spa, Warks, CV32 5RZ to earn yourself a royalty of up to £50.

**WANTED** Amstrad CPC colour monitor and Star LC 10 printer. Will pay cash or swap for games. Tel: North Tyneside 268640.

**SEGA MASTER** system cartridges wanted. Cash waiting, postage paid. Phone now. I want your unwanted cartridges. Tel: 0282 38408.

**MEGA** drive games. Will swap for Amiga originals or Atari Lynx games. Call Derek 0292 77300 after 5 p.m.

**I NEED ST PD!** to start collection. Disks returned. + PD in exchange. HI to DES + SYKO. Rich 52B Huncote Road, Narborough, Leicester LE9 56N.

**WANTED!** CM8833 monitor with guarantee. 3.5 inch drive as above. Money waiting. All for ST. Tel: Rich 0533 867369

**AMIGA ASOO**, preferably with software, joystick. Doesn't matter if games are backed up. External drive. Not bothered about pay. £250 o.n.o. Tel: Leicester (0455) 283237.

**BATTLE CHESS**, OP Thunderbolt, Kick Off 2, Hawkeye, + any for ST. Jon Sibley, 65 Granby Close, Weymouth, Dorset, DT4 0SR.

**NIGHTINGALE** telephone link for BBC, want to swap for printer or will sell. Tel: (0234) 272345.

**A & A SUPPLIES**

Wide range of Commodore and Atari products including Amiga Batman/Flight of Fantasy Pack at very competitive prices

Please ring Jason for details  
**0908 216312**

14 The Green, Newport Pagnell,  
 Bucks MK16 0JW  
 FAX: 0908 211057  
 24 Hour credit hotline  
 0908 216312



**MSX2** or **MSX DEVPACBO** wanted. Also any **MSX2** or **MSX** disk owner contacts. Please write: David, 15 Fairhaven Road, Leyland, Preston, Lancs PR5 3HY.

**PHILIPS** 8533 screen and A590 harddrive wanted. Will pay well. Write to: Jamie, 6a Clifton House Close, Clifton, Beds SG17 5EQ

**MIDI CONTACTS** wanted for ST to provide source code Midi files, etc. Help appreciated as new to machine. Phone Glenn, Chertsey 0932 567614.

**SHEFFIELDS** alternative solution BBS 0742 325232 8NI 24 hrs HST. Atari ST IBM PC Amiga BBC Downloads. No fee.

**WANTED** for C64-Disk - Hunt for Red October. Must be original. Phone Graham 0670 856886.

**WANTED** copy of manual and circuit of Heathkit OS2 Oscilloscope. Phone 0744 27067 Lancs.

**VGA COMPATIBLE** entertainment software (Shareware), packed 3 1/2" menu driven disk either 1 x 1.44m or 2 x 720K disks, £6 incl. or s.a.e. for info. 9 Ithens Way, Sontley Road, Wrexham, Clwyd.

**AMIGA** monitor wanted. Swap for Atari Lynx 8 three games as new. Steve 36 Stanway Street, Gorsehill, Stretford, Manchester M32 0JL.

**WANTED!** AN ST graphics guru who can also put text onto paper. Join the team at STEN, the ST disk mag: (081) 546 0993.

**BARD'S TALE** wanted desperately! PC version 3.5 or 5.25. Phone John 071 241 1585 after 7 p.m.

**ATARI** or Philips colour monitor for ST. Ring Tom Zunder, 0709 700637.

**KEEN** young (14) enthusiast requires VIC20 hardware attachments, e.g. disk drive, master control board, etc., etc. Tel: 0737 552808.

**AMIGA**, GFA basic interpreter + compiler. Must be original and have manuals. Swap for original games or buy for cash. Hurry! Mike, 12 Lichfield Court, Gladstone Street, Winsford, Cheshire, CW7 4AB.

**UNWANTED** broken Atari ST wanted for spare parts for project. Ring 081-969-5912, ask for the professor.

**AMIGA A500** wanted. Also monitor, extra drive, etc. Cash waiting. Tel: 091 511373. Ask for Paul. Thanx. G.T. 3.5 inch disk drive for Spectrum plus three. Phone Ian 0207 237000 after 7 p.m., not Tues/Thurs.

**WANTED** any Sinclair Spectrum computers and accessories, working or not. Can only pay postage. Hard up experimenter. Ring Steve Mon-Fri (071) 480 6263.

**ATARI "ST Adventure Creator"** software plus manuals wanted. Swap for original software. Also looking for PD source code for the "Adventure Game Toolkit" games. Tel: (021) 422 7579.

**MX80TP** manual or photocopy needed. Ring (0256) 29994 ask for Tony.

**WANTED** please. Panasonic KX-P1081 operating manual for this popular printer. Phone Bognor (0243) 867565.

**WANTED** mouse for Amstrad PCW8000 series. Cash waiting up to £20. Phone (061) 799 1813.

**FLEX1** - Dump plus for Atari ST and Star LC10 (colour), and Vidi ST must be working and cheap. (0705) 453985.

**WANTED** Pools Prediction Program for ST. Ring Dave (061) 442 6887. Electronic components also required.

**WANTED** Metawindow for C and any C graphic library for Turbo C. Contact Gary, Tel. 071 2728436

**GRANDAD** bought Amiga 500 but discovered lack of educational programmes for children to 16+. Anyone got a BBC emulator and programs urgent please write. Mr G Sutcliffe, 22 Towers Ave., Deane, Bolton, Lancs., BL3 4JN

**SPECTRUM+** complete with joystick £30. Alphacom printer c/w 10 rools £55. Microdrive expansion kit c/w two microdrives £55. 30 microdrive cartridges £50 or all for £170. Tel. 0983-402273

**BARGAIN OFFER** Atari 8-bit 65XE. Some games, cartridge tapdeck, joystick - take it off me for £70. Bob, 43 Kingsway, Newcastle, Tyne & Wear, NE4 9UJ. First reply C.O.D.

## Let this advertising space work for YOU!!

### For Only £56

### Contact Tim Partridge

on

### 0225 442244

#### A SMALL SELECTION FROM OUR WAREHOUSE

	RRP	WAVE	
Genius Mouse + OCP Art Studio & Mouse Mat & House.....	£49.99	£44.99	C
Thermal Paper, ZX Printer.....	BOX 5 £12.50	£10.63	D
Multiface 1, Spectrum 48K.....	£39.95	£31.96	E
Multiface 128, Spectrum 128K/+2.....	£44.95	£35.96	E
Multiface 3, Spectrum +3.....	£44.95	£35.96	E
Spectrum 48K Membrane, SL201835.....	---	£4.80	E
Spectrum + Membrane, SL201986.....	£15.00	£6.50	E
CF2 3" Maxell, All 3" Drives.....	BOX 10 £29.90	£15.99	E
Spectrum + 3 Sinclair Light Phaser, Complete with 6 games..	£29.95	£11.99	C

**DO YOU WANT TO SAVE MONEY, THEN SEND FOR OUR TRADE PRICE LIST STATE FOR WHICH PRODUCTS AND ENCLOSE 3 22P STAMPS**

**ENG. MAINLAND** post & ins.: (A) £5.75 (B) £4.60 (C) £3.45 (D) £2.30 (E) £1.15 (F) 58p (ANC) 3 Day £10.35 Next Day £13.80, COD +£2.30, Max. UK post chg. £8.05 per 20kg/£500. **ALL PRICES INCLUDE VAT.** All sales subject to our Trade Terms of Trading.

**W.A.V.E. (Trade Dept. NCE 2710)**

**WALNEY AUDIO VISUAL & ELECTRICAL DISTRIBUTION**  
1 Buccleuch Street, Barrow-in-Furness, Cumbria, LA14 1SR  
Tel: 0229-870000 (6 lines) Hours: Mon-Fri 10.00-5.00

**ATARI LYNX** plus three games as new. Wanted Amiga monitor or suitable monitor colour only or swap W-H-Y. Steve 36 Stanway Street, Gorsehill, Stretford, Manchester M32 0JL.

**WATFORD MK2** 1772 single double density DFS for BBC "B". Tel: 0533 601679.

**APRICOT F2** or F10 wanted. Tel: 0573 24283.

**ANYONE** with a mouse for the Sinclair QL. I'll pay up to £16.00. Tel: (0482) 847958.

**ATARI ST** mouse wanted. Must be working. Phone 0900 67597 after 6.30.

**IF ANYONE** has an original C64 copy of Machine Lightning I will offer a good price. Phone David 0666 504860.

**ADVENTURES** wanted PD/Shareware Text/Graff, new library with mag in the making covering Spectrum tape/disk, SAM OPUS/3.5 microdrive. Send with s.a.e. to G./Howard, 4 Chatterton Avenue, Lincoln LN1 3TB.

**BROKEN** Amiga A500 wanted any condition considered. Cash waiting. Must live within 50 miles of South Lincolnshire. Tel: 0778 393470.

**PRINTER** head for Okimate 20 printer. G Power, 6 Renoir Mews, N. Bersted, Bognor Regis, W. Sussex PO22 9AU.

**WANTED** C64 Easy Spell. Newsroom. Clip Art. Print Shop. Please write to Paul, 42 Chesterfield Road, Worthing, BN12 6DD. Disks only please.

**PC Software**, any vga 3 1/2" games, DTP, Protext, Super Mailshot plus etc. Also Ad Lib. Soundboard wanted and internal modem. Must be reasonable (0782) 324799.

**STAR LC-10** colour printer with ribbons - only £135. Also Amiga games from £4 each. Tel. 081-558 5698.

**ATARI 520STE** with Philips CM8833 monitor plus lots of software and covers. Five months old. £499 only. Tel. 021-453 1344.

**ATARI 520STFM** with external drive, mouse and Metacomco ST Basic £220. Tel. Gary on 0293-34415 after 6pm.

**AMSTRAD CPC** disk games for sale £5 each. Also Ace mags, issues 8 - 33 + 10 assorted mags £3 the lot. Tel. 0529-305402.

**SPECTRUM +2** including complete art package, many games - all original. Selling because of upgrade. Tel. 0364-529290 ext. 210.

**MUSIC-X** or DRT's user manuals wanted swap for IFF samples or pay cash plus general music x-chance inc. tips etc. Ring 0742 6869977 (ICE) now.

**WANTED**, BBC Master. Will buy or exchange for top class metal detector with extras, cost £500. Tel (0246) 826766.

**HELP** needed to match Tandy TRS80II printer to Amstrad 1640. Call Torquay (0803) 214413 evenings or write to Flat 3, Lucerne, Lower Warberry Road, Torquay.

**WANTED** Atari Lynx or Gameboy type portable game machines with extra games if poss. Please tel. (0619) 626377.

**AMIGA IFF** sounds- send me a disk full - I'll send a disk full back! James Meehan, Pier House, Strand on the Green, London, W4 3NN

**USERS** handbook for Commodore 64 Easyscript ESC 6440. R Clarke, 10 Saxon Court, Bull Lane, Maldon, Essex, CM9 7HS. Tel. 0621 859499

**NEW AMIGA MOUSE** for sale only £10. Also Amiga modulator only £10. Phone 061-338 5566 after 4pm and ask for Richard.

**ATARI 520STFM** with 2Mb double-sided drive. Mint condition with boxes. Sell for £220 ono. Phone Paul on 0272-652754 after 5.30pm. Quick sale needed. Phone Now!

**SEGA MASTER** system + light gun, 5 games incl.: Shinobi, Thunderblade etc. VGC and boxed £70 no offers. Tel. Michael on 07742-365243 after 6pm.

**SPECTRUMS** for sale, plus hardware, software, books for various micros. SAE to Mr Jones, 2 Town Mead, Oakford, Devon, EX16 9EW.

**AMSTRAD CPC464** with colour monitor, disk drive, speech synthesizer software, all manuals and magazines £400 ono. Tel. John on 0383-737474

**ZAT** the Fanzine for Spectrum and coupe users! Issue 4 out now. Interviews, strips, and more. Send 60p and stamp to: ZAT, PO Box 488, Tweedale, Telford, Shropshire TF7 4SU.

**MESSYDOS** problems on Amiga? After placing on mountlist and mounting type dir msh: For the Amiga to recognise the new file system (KFC).

**FDKIT v316e** is now available for the PC. The most talked about utility program of the 90's for your (almost) free copy - call (0604) 843034.

**STEN** - ST enthusiasts newsletter - free, send disc and SAE for your copy. Dave Mooney - 14 School Road, Morningside, Newmains, Lanarkshire (0698) 382380.

**80 Column** card for the Einstein wanted. Any back no's or Einstein Monthly mag also wanted. G Constable, 77 Barnwell St, Kettering, NorthHants, NN16 0JD





**IF YOU WANT  
NAKED LADIES  
CUT THROAT PRICES  
COWBOYS  
TRY ELSEWHERE,**

**BUT IF YOU WANT**

Good prices, good service and a good product range covering all leading Midi/Music packages, education, art and graphics packages plus business packages please contact us.

**FOOD FOR THOUGHT**  
DON'T THINK CHEAPEST IS ALWAYS BEST  
DON'T BUY GREY IMPORTS  
DON'T PAY UNTIL YOU'RE SURE  
DO REMEMBER THAT AFTER-SALES SERVICE IS WORTH  
IT'S WEIGHT IN GOLD

**REPAIRS: NO PROBLEM**  
WE HAVE OUR OWN SERVICE DEPARTMENT  
Mon-Thurs 11am-9pm Fri-Sat 11am-7pm

**SGM Electronics, 19 Charles Street, Wigan, Lancs WNI 2BP**  
TEL: (0942) 321435 FAX: (0942) 821273

**SOFTCELL SUPER SAVERS**  
PC Share Ware  
£1.75 Per Disk Fully Inclusive

PC Type II (3)	£5.00
NY Word (3)	£5.00
PC File dB (3)	£5.00
PC File (3)	£5.00
Front Office (3)	£5.00
PC Type (3)	£5.00
PC Calc (3)	£5.00
PC File + V3 (3)	£5.00
Freeway Accts (3)	£5.00
Ford Car 11 (2)	£3.50
Super Astrology (3)	£5.00
Page Finc. Cont. (3)	£5.00
<b>£5.00 Set £6.00 3.5</b>	

EGA Pacman	£1.75
Deskjet Collection	£1.75
Educational Games	£1.75
Dr. Sleep	£1.75
Laser Letterhead	£1.75
Home Records	£1.75
Share Spell	£1.75
Bar Codes	£1.75
Windows Toolkit	£1.75
Windows Games	£1.75
base 4 Tutor	£1.75
Food Analysis	£1.75
<b>+ 100's more</b>	

**COMMODORE  
STARTER  
PACKS  
FROM  
£498**

**SCHNEIDER  
COMPUTERS**  
• Quality  
• Value  
• Free Software

10 5/14 Discs £16.00, 10 3 1/2 Discs £25.00  
For further details write or phone  
for a FREE catalogue!

Softcell Services, Dept NCE, 25 Maywood, Brynna, Pontyclun,  
Mid Glamorgan, CF7 9PZ. Tel: (0443) 238630 anytime

C64 "Magic Micro Mission" cassette (Quicksilva) please. Generous price offered for original in good condition. Call Simon on 021 4227970

WANTED cheap hard drive for Amiga cash waiting. Up to £250 for best offer. Phone 0695 423161 daytime only. Ask for Mike.

PROTEXT V4 for sale for the PC range of computers and compatibles. Brand new £30. Tel. 0705-696543.

COMPUTER MAGS - Zero 1-7, Ace 26-31, The One 13-19 £22 ono. the lot Tel. 0968-75014, ask for Rev. Henderson or leave a message on the machine.

WANTED: Bubble Bobble for the Amiga. Tel. 081-390 2068 evenings.

AMSTRAD PC2286/2386 for sale. Microsoft Windows + MS-DOS 3.5" disk format. Reasonable offers. Tel. 0904-625016.

SPECTRUM + manual wanted, outlet and Enigma progs on tape or microdrive. Also, ZX Spectrum - How To Get The Most Of It and a broken interface. J Heinrichsons 16 Kimmeter Place, Annan, DG12 6JU.

BBC B for sale, needs tape deck or disk drive, some tape games. Good condition only £75. Tel. 0255-434740 Andy after 6pm.

ATARI Portfolio pocket PC only 6 months old. Sell for £220 ono. Still in box as new. Tel. 0389-52680.

ST DECISION in the Desert by Microprose wanted. Will pay up to £15. Phone 051 645 2997 after 4 pm. Ask for William.

AMIGA games wanted. Also any offers of help. New owner who ain't got a clue. Steve, 36 Stanway Street, Gorsehill, Stretford, Manchester, M32 0JL.

WANTED Vic-20 tape recorder and/or games. Will swap for sharp pocket computer or cash/negotiable. 21 Whitehorse Street, Hereford, HR3 0EP

EPSON MX-80 printer manual required. Buy or borrow. Reasonable price or postage paid. Tel. Nottm 0602 289698 after 6:30 pm

PORTFOLIO Atari/DiP. Good condition only. Name your price! 0251 264962

WANTED cheap hardcard or disk for AT compatible. Any size considered as long as it's cheap. Steve 0705 375409

WANTED anyt good AD+D games on C64 disk eg. Dragon Wars. Also Salamander2 for sale for the MSX E15. Write to N Raithby, 27 Runswick Road, Grimsby, CN32 8HD

FIRST Word Plus wanted for the ST V3 only. Will pay cash. Ring Stef 0469 60009

A courier HST 19200 Baud Rate Modem. Must be 100% working. Contact me now! Also Amiga contax wanted! See Ya! Tahir, 134 Bellingdon Road, Chesham, Bucks., HP5 2HF

CANVAS Art Program fed up with the on line manual? Need a professional print-out? £4 including folder - Peter Kempley, Aldershot 313566

HELP offered with any aspect of Quickbasic Programming. Write with SAE to: Howard Glynn, 7 The Gardens, Monkseaton, Whitley Bay, NE25 8BG

NM156 is the best, if you have a C64 then forget the rest! If you like a good game then remember my name. N Higgins, 109 Edward Street, Denton,

WANTED - hard drive for use with ST. All offers welcome. Robert Wood, 16 Gordon Road, Shoreham, West Sussex, BN43 6WE

AMIGA formal issue six, will pay £3.45 if in good condition with disk. Tel. St Albans 0727 58864 after 6 pm weekdays.

WANTED: 1 MEG STFM disk drive internal only. Tel. 0993 84558859 after 5 pm

WANTED: Amiga A590 harddrive (must have packaging and be in VGC). Also required 1.3 version professional page templates etc. 0770 749630

UNDERWURLOE wanted for 48K Spectrum. Write with price to Scott, 20 Nene View, Islip Kettering, Northants., NN14 3LD. Only "Ultimate" original

MSX Disc drive wanted and 80 columns cartridge for Spectravideo Express. Also circuit for Pioneer PX7 Dave 0908 501310 Milton Keynes.

EMULATE! THE independent Amiga Amax user group now setting up all Amax users. Write to Emulate! 126 Nothbrooks, Harlow, Essex.

ATARI ST/STE disk mag issue news, PD, DTP etc. Free! Send blank disk and SAE to Paul Sealy, 31 Hartfield Crescent, West Wickham, Kent.

BEEB Public Domain! Send SAE to: Rafael Jay, Onslow House, Weston Road, Bath, Avon BA1 2XX for catalogue.

BOOK on machine code for the PC. N O Duncan, 10 Anstey Close, Basingstoke, Hants, RG21 3JG

**BUYING AND SELLING PCW's  
PLEASE CONTACT**

**Brian Mound,  
401 Brooklane, Billsley,  
Birmingham B13 0HD  
Tel: 021 778 2906**

AMIGA PD for just 80p only. Just started up! SAE for list to R & G PD, 123 Melmount Gardens, Strabane, Cotyrone, N. Ireland. Also cheap PD wanted!

SHEFFIELD'S alternative solution BBS 0742 325232. V21/22/22B1S/32/14.4K HST 8N1 24 hours. Apricot F1 720K floppy drive wanted. Why?

WANTED Broken Amiga 500 any condition considered, must live within 50 miles of south Lincs. Tel (0778) 393470.

ADAMSKI N-R-G CD single wanted or Pet Shop Boys Opportunities (any format) contact Grainger on (0536) 67520.

WANTED Multiface II plus Printmaster for Amstrad CPC 6128. Tel (0203) 362063 anytime.

WANTED Apricot F1E. Sensible prices please. Also required software (Wordstar/Cobol). Ring Nic (0392) 433579.

WANTED Amiga A2000 with or without monitor. Must be in good condition. Cash waiting. Ring (021) 471 3335 Simon.

ANY computer system wanted. Phone on Hackney 249 7637.

PC Engine CD Rom unit wanted. Swap for megadrive and Gameboy plus games. Phone Rich 051 922 7642 mornings only 10 to 12.

VARIOUS BBC equipment for sale including keyboard, printer screen etc. All offers considered. Tel. 0277-654095.

SPECTRUM 48K+ with 100 games. Only £100. Call us on 0272-324230.

WANTED 64K MEMORY expansion for CPC664. Also system disks for 6128. Reasonable prices please. Write to S W Bain, 59 Cummings Park Circle, Aberdeen, AB2 7AL

TANDY DMP106 printer. Serial/parallel dot matrix £80 or exchange for CBM MPS printer 0709-853786.

SPECTRUM ROM DISASSEMBLY and other books. Send SAE for details to: M Perry, 216 Marlpool Land, Kidderminster, DY1 15DL.

USERS manual Apple II Silentype printer type A2M0032 wanted. Also full circuit diagram for printer and board. Cash waiting Hobden St Blazey. Tel: Par. (072 681) 7166.

BBC MASTER 128 microcomputer, monitor, 40/80 track drive, data recorder. Little used. £500. Tel. Basingstoke 781408.

WANTED V22bis modem for ST auto answer and dial pref. Tel (0383) 822930 after 6 pm, ask for Steven.

**Whiterose Computers**

**No. 1 in West Yorkshire for Atari ST & Amiga**

Also..A range of PC and PCW systems plus Commodore C64c-Nintendo and Atari VCS(2600) hardware all in stock.

Software for all the above Plus ...Atari XL/XE Cassette/Disk & cartridge/7800 - Spectrum Cassette/Disk - Amstrad CPC Cassette/Disk.

Leisure/Entertainment, Education, Graphical, Business & Music packages **ALL AT DISCOUNT PRICES** 1,000s of tapes and disks in stock!

Monitors, Printers, Disk Drives, RAM upgrades, Cassette Units, Ribbons, Disks, Storage Boxes, Joysticks and Interfaces, Cleaning Kits, Mice(C64 - ST - Amiga - PC Etc.) Plugs, Leads, Stands for printers & monitors also Dust covers Cassettes, Head alignment kits, & lots more!

**Check out our ST PD library - over 220 disks now in!**

Open 6 days a week 10am - 5.30pm Whiterose are two thirds of a mile from J26 on M62 next to the traffic lights/crossing

**Whiterose Computers, Brooklyn Court, Bradford Road,  
Cleckheaton, West Yorkshire, BD19 4TJ Telephone 0274 851131**

## ACORN AMSTRAD ATARI COMMODORE Z88

Citizen Panasonic Star Aries Epson  
PRICE-BUSTING THE LEADING BRANDSArchimedes Specialist  
Established SIX Years

"Solid As A Rock"

Our Own Service Division 041-332-0625

Scotlands Leading Micro Specialists

## THE COMPUTER DEPOT

205 Buchanan Street, GLASGOW 041-332-3944

55 Clerk Street EDINBURGH 031-668-4146

Inshops Wellgate Centre, DUNDEE 0382-29653

Licensed Credit Broker \*Mail Order\*

Ex-Demo  
Many  
BargainsEXPRESS  
BARGAINSIBM PC Clone at, 20MB hard disk, 3 1/2  
+ 5 14 hi density floppy, UG A colour  
screen, £750. 0444 400763 (West  
Sussex).CHEAP! S/S internal drive \$15, Synchro  
Express V2 £110, Learn Assembler  
book £8, 30 great games: 3d Pool, B  
Money, etc. £5. Tony 0590 683245.COMMODORE 64, C2N, S/ware, books  
£100. Also MSX boxed, tape recorder,  
some S/ware including assembler £65.  
Phone 0751 33313 N. Yorks.AMIGA BOOKS. Amiga for Beginners,  
Basic Inside and Out, Machine  
Language, Tricks and Tips, Dogs Inside  
and Out, All Abacus, unused £9. 0224  
824904.FOR SALE STE 4 meg upgrade simms  
£160. If interested contact S. Black, 18  
Paul St, Lochgelly Fife, KY5 9AL.AMIGA-AMOS C/W extras disk only  
£25. Aegis Sonix £20. Both originals  
C/W manuals etc. Details tel 0692  
402927.AMIGA 500 Plus 1/2 mega and extra  
disc drive and amber monitor still under  
guarantee. No offers. £350. 081 207  
5837.

## COMPUTER REPAIRS

Fixed Super Low Prices/  
Inclusive of parts, labour and VATFIRST AID  
FOR  
TECHNOLOGY

1 WEEK TURNROUND

\* AMSTRAD / SINCLAIR AUTHORISED \*

SPECTRUM 48K	£14	C64	£22
SPECTRUM 128	£18	VIC 20, C+4	£22
SPECTRUM +2	£27	1541 DISK DRIVE	£36
C128	£29	C2N TDECK	£19
C16	£18	C64 PSU for sale	£27
Amiga	POA	Atari ST	POA

Please enclose payment with item - 3 month warranty on repair.  
Please enclose advert with repair.W.T.S. ELECTRONICS LTD  
(NCE 18 10 90)

Studio Master House, Chaulend Lane, Luton, Beds. LU4 8EZ

Tel: 0582 491949

(4 lines)

Standard terms of business apply

MAC S.E. and 30 MEG hard drive and  
high res. mono. monitor. Sell for £800  
call Dave on 051 4282280.AMIGA 500 hardly used mouse,  
joysticks, Batman, 10 Star pack,  
Superbase, Personl, Populace, Lots  
games, utilities over £500 total. Bargain  
£350. Tel. 0751 76882 N. Yorks.SEGA Megadrive, Scaet Ten, latest  
titles, two joypads, leads, power supply,  
mint condition. £320 ONO. Tel. 0482  
668669 after 6 pmSINCLAIR QL with manual, software,  
games, typing tutor, joystick and 10  
spare microdrives. Little used, less than  
1/2 price at £79. Telephone 0582  
768653 evenings.MSX Toshiba HX10, HX-564, Wordpro,  
Computermates, 'MSX text/cards', cart  
games including 1942, Nemesis 3.  
Carts, programming books/mags,  
joysticks, datacorder £100. Phone for  
details on 0642-564932AMIGA A501 expansion genuine  
Commodore £50 cumana 3.5" drove £55  
both mint and boxed with guarantee.  
0705467943ATARI ST "original" games, Oticitys etc  
for sale or swap. What have you for dist  
write to Ricky 26 Fairfield Place,  
Ruesham worse, WR11 6HE.PUBLIC domain for the IBM PC. 350  
titles available for the price of a blank  
disk. Tel. 0533713867 for details.AMSTRAD 464, DDIdisc drive, TV  
tuner, colour monitor, loads of games,  
mags etc. excellent condition £160. Ring  
Emma on 0665 6036533.AMSTRAD 6128 software all originals,  
serious and game, inc Devpac 80, "C",  
Image Sys, Hits 6, Biggles. Call Gary on  
0908 220486 (evenings).ATARI ST single sided drive, have  
upgraded so asking £25 inc P + P.  
Phone Gary, evenings on MK 0908  
220486.AMSTRAD CPC 464 colour monitor.  
Over £510 software/utilities. Manual.  
Over 35 mags. Light gun. Bargain at  
£550 ONO. Contact Adam Hawkey 073  
084 514.BBC 'B' 128 K, C/W green monitor, twin  
and single D/sided drives, joysticks,  
interface, business, ed. soft. £300. 0296  
21227.CBM 1541-11 disk drive and 20 blank  
disks, hardly used and boxed. Only £80.  
Phone Jason 0753 660066 (Slough)  
9am - 5pm.MEGA BRILL games Rocket Ranger  
and Rick Dangerous for sale or  
exchange on the PC "RR" for £25 "RD"  
for £20. Phone Dave on 0265 51851.AMIGA PD for sale. Lots and cheap.  
Send S.A.E. to: Jason Meachen, 59  
Lee Road, Dovercourt, Harwich, Essex,  
CO12 3SB. (No callers).PROTEXT V5 word processor for Atari  
ST brand new! £95. Phone 0529  
305611.

**COMPUTERTEC HIGH QUALITY AMIGAST**  
SPECIALISTS HOTLINE (0502) 584908

HARDWARE U.K. ONLY		GAMES		SPECIAL OFFER ON AMIGA 500 UNTIL CHRISTMAS	
(Free Delivery) (Courier £5.00)		Amos Games Creator	£33.50	Sim City	£18.50
Amiga A500 F.O.F. Pack inc TV Modulator, F29, Robot Monsters, Rainbow Islands+10 blank disks	£359.95	Ant Heads	£12.75	Speedball	£13.00
Amiga A500 Screen Gams Pack Back to the Future II, Days Of Thunder, Shadow of the Beast, Night Breed, D Paint II, 10 Blank disks	£359.00	Attack Sub	£17.50	Stunt Car Racer	£16.90
Amiga A500 Class of 90's Pack inc TV Modulator, Educational Pack	£499.95	Batman The Movie	£15.90	Super Hang-On	£14.50
		Battle Chess	£16.95	Super Wonderboy	£17.50
		Battle of Britain	£18.75	Street Fighter	£8.90
		Cadaver	£17.90	Tin Tin on the Moon	£14.75
		Conqueror	£17.50	Trivial Pursuit Genius	£14.75
		Corporation	£17.90	Turbo Outrun	£16.90
		Double Dragon II	£15.50	Turbo Cup	£11.50
		Dragons Breath	£20.50	TV Sports Football (US)	£17.50
		Dragons Lair (1MB)	£32.50	TV Sports Basketball	£16.25
		Dragons Lair II	£32.50	The Three Stooges	£12.75
		E-Motion	£17.50	Turrican	£16.90
		F29 Retaliator	£16.90	Teenage Mutant Turtles	£21.50
		Fast Break Volleyball	£12.50	Untouchables	£17.50
		Fiendish Freddy	£17.50	UIMS 1	£16.50
		Flood	£16.90	UIMS 2	£17.50
		Ghosts & Goblins	£14.50	Voyager	£9.50
		Grand Prix Circuit	£11.50	Wicked	£8.75
		Hit Disk Vol 2	£13.50	Who Framed Roger Rabbit	£14.50
		Hybris	£11.50	Wings of Fury	£17.50
		Indy Jones Action	£15.50	Wild Street	£17.50
		It Came From Desert	£16.50	Xenophobe	£16.50
		Kick Off Extra Time	£8.90	Xenomorph	£16.90
		Klax	£15.50	X-Out	£16.50
		Leisure Suit Larry 1	£19.50	Menace	£11.50
		Leisure Suit Larry 2	£21.50	Nuclear War	£17.50
		Leisure Suit Larry 3	£21.50	Op. Thunderbolt	£17.50
				Operation Wolf	£16.90

Prices all include VAT & P.P. in U.K. Europe please add £2.00 per item. Return of post service on stock items. Cheques subject to clearance HOME

Please send Cheques/Postal orders MADE PAYABLE TO:  
**COMPUTERTEC**, 1 Lovewell Road Lowestoft,  
Suffolk, NR33 0RO. TEL. (0502) 584908

TURN YOUR COMPUTER INTO A HIGH QUALITY HOME  
RECORDING STUDIO WITH THE LATEST C.M. RANGE OF  
PRODUCTS FROM ROLAND

PACKAGE 1	CM32L sound module, Dr. T's tiger cub sequencer	£469
PACKAGE 2	PC200 midi keyboard, CM32L, sound module, Dr. T's tiger cub sequencer	£643
PACKAGE 3	PC200 midi keyboard, CM32P sound module, Dr. T's tiger cub sequencer	£719
PACKAGE 4	PC200 midi keyboard, CM64 sound module, Dr. T's tiger cub sequencer	£1063



- \* All connecting leads included.
- \* Midi/sequencing course available.
- \* Mail order service.
- \* Midi helpline - 0795 425931

3 ROMAN SQUARE, SITTINGBOURNE, KENT, ME10 4BJ  
(0795) 425931

## !!! AMIGA GAMES PROGRAMMERS !!!

Want to write Amiga games?

Need help programming the custom hardware?

The AMIGA GAMES PROGRAMMERS GUIDE is a new book explaining all aspects of game-writing!

Including Copper, Blitter, Sprites, Audio etc. & source code!  
For FULL DETAILS, send an SAE NOW to: Ditchburn Computers,  
2 The Woodlands, Nunthorpe, Middlesbrough, Cleveland TS7 0PH.SPECTRUM UTILS for swap, White  
Lightning, Gac, The Writer, Zues, want  
other utils, or Elite for +3. 0232 230410.CIG ORIGINALS over one hundred  
boxed. Send S.A.E. or buy the lot for  
£50 + P & P. 44 Elm Park, Clonmel, Co.  
Tipperary, Eire.ATARI STFM, 1MB drive, some games,  
mouse, cables, all manuals, language  
disk, good condition only 10 months old.  
Worth £290 will sell for £190. Tel. 081  
681 1940 anytime after 7:30 pm. Ask for  
Joe.ATARI 520STFM 0.5 meg drive and  
colour T.V. (can be separated), two joy-  
sticks, £500 + worth of software and  
blank disks. £230. Contact 0670  
822647.OLIVETTI PR15 PRINTER for sale £75  
ono. If your interested call Andrew on  
Preston 0772-314947 anytime.AMSTRAD PCW 8512 with Mini Office  
Professional + 7 blank branded disks  
and case. £250 for the lot. Call Tommy  
on 081-852 8578 after 6pm.AMSTRAD 6128 colour monitor and TV.  
Also mono monitor plus loads of  
software £275 or will split. Tel. 0793-  
610325 (Swindon) anytime.SEGA MEGADRIVE (Scart) with eleven  
top titles. Everthing boxed. Sell for £320  
ono. or swap for Super Grafix with  
games. Tel. 0306-885003ATARI ST games Stac, Pirates,  
Gunship, Scrabble, Starglider 2,  
Balance of Power - all with original docs  
etc. £45 ono. Tel. 041-632 9903 after  
6pm.TRADE BINATONE midi hi-fi with CD  
player and compact disc for Atari STFM  
or STE or Amiga. Cost £300 - contact  
Lee on 0226-758256

# MICROSMART MAIL ORDER

Tel: 0908 564369

## AMIGA A500 SCREEN GEMS PACK

£369 inc. VAT & next day courier

### Screen Gems Pack Includes:

- ★ Amiga A500 512K keyboard with built in 1 Meg disk drive
- ★ Free TV Modulator worth £24.99 allowing you to use the Amiga with a normal TV.
- ★ Joystick, Mouse Mat + 10 blank disks, Mouse & Mainsplug
- ★ Amiga Basic, Amiga Extra's 1.3 Workbench 1.3 PLUS Amiga Step by Step Tutorial
- ★ With a further four new releases - Shadow Beast II, Back to the Future II, Nightbreed, and Days of Thunder
- ★ Software has a potential RRP of £200

## AMIGA A500 SCREEN GEMS PACK +

10 FREE GAMES

£399 inc. VAT & next day courier

### Screen Gems Pack Includes:

- ★ Amiga A500 512K keyboard with built in 1 Meg disk drive
- ★ Free TV Modulator worth £24.99 allowing you to use the Amiga with a normal TV.
- ★ Joystick, Mouse Mat + 10 blank disks, Mouse & Mainsplug
- ★ Amiga Basic, Amiga Extra's 1.3 Workbench 1.3 PLUS Amiga Step by Step Tutorial
- ★ With a further four new releases - Shadow Beast II, Back to the Future II, Nightbreed, and Days of Thunder
- ★ Software has a potential RRP of £500

## AMIGA A500 SCREEN GEMS PACK

+ 10 FREE GAMES + MONITOR

£599 inc. VAT & next day courier

### Screen Gems Pack Includes:

- ★ Amiga A500 512K keyboard with built in 1 Meg disk drive
- ★ Free TV Modulator worth £24.99 allowing you to use the Amiga with a normal TV.
- ★ Joystick, Mouse Mat + 10 blank disks, Mouse & Mainsplug
- ★ Amiga Basic, Amiga Extra's 1.3 Workbench 1.3 PLUS Amiga Step by Step Tutorial
- ★ With a further four new releases - Shadow Beast II, Back to the Future II, Nightbreed, and Days of Thunder
- ★ Software has a potential RRP of £500
- ★ Second to none graphical pictures with 4096 colours and stereo sound including lead for the ST or Amiga



## AMIGA A500

CLASS OF THE 90's

### BUSINESS + EDUCATIONAL PACK

£529 inc. VAT & next day courier

#### FEATURES:

- ★ Amiga A500 - TV Modulator
- ★ Midi interface - Software
- ★ Kind Words 11 word processor
- ★ Page Setter DTP
- ★ Super Base Personal Database
- ★ Maxplan 500 Spreadsheet
- ★ Amiga Logo BBC Emulator Deluxe Paint II
- ★ Mouse Mat, 10 blank disks and disk wallet

## MICROSMART SOUND & VISION A500 PACK £399

#### Including:

Amiga A500 512K keyboard with 1 Megabyte disk drive. Free TV modulator worth £24.99 allowing you to use the Amiga with a normal TV. Deluxe Paint II graphics package. Fantavision - animation package. Sound Express - state of the art stereo sampling, includes free software and hardware. Shadow of Beast II - horizontal scrolling games software. Back to the Future - film action software. Nightbreed - state of the art graphical arcade action. Days of Thunder - serious fast action games software. Free joystick mouse mat, and 10 blank disks. Amiga Basic, Amiga extras, Workbench 1.3, plus Amiga Step By Step tutorial. All leads and manuals plus mouse and mains plug. Plus 5 FREE games.



## HALF MEGS + DRIVES

HALF MEGS: £34.99

Quality four chip Ram board with complete utility disk support with software, on/off switch.

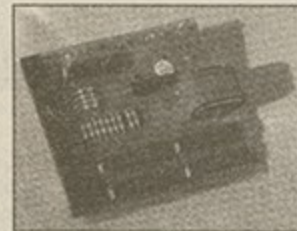

AMIGA + ST DRIVES: £59.99

A powerful 880K formatted drive with an external on/off switch, anti clicking and daisy chain facility

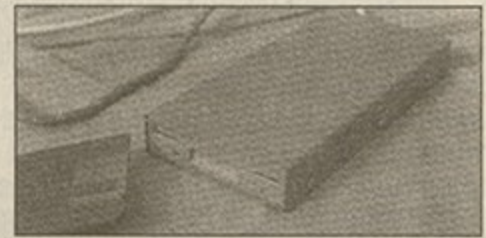

## MONITORS £259

4096 coloured stereo monitor with first class reproduction including leads for ST & Amiga



## MICE

NAKSHA MOUSE: £26

Quality microswitched, accurate Amiga, ST or Amstrad PC Mouse



CONTRIVER MOUSE: £18

The perfect direct replacement mouse for the ST or Amiga

## PRINTERS

LC10

The most popular letter quality printer on the market. With all Amiga + ST leads  
Only **£219.00.**

**MICROSMART 24 HR HOTLINE 0908 564369**

TITLE	COMP	PRICE
<b>TOTAL COST £:</b>		

Have you ordered from us before? YES NO

Name .....

Address .....

.....

.....

Tel No: .....

Please send this to **Microsmart**, 125 High St,  
Stony Stratford, Milton Keynes, MK11 1AT

NCE 103

# Evesham Micros

- ALL PRICES INCLUDE VAT & DELIVERY -

Buy with confidence from one of the longest established companies in their field, with a reputation for good service and prices. We have invested heavily in a computer system to enable our Telesales staff to provide up-to-the-minute stock information, coupled with highly efficient order processing. Our fully equipped Workshop enables us to carry out almost any repair on our premises. We feel sure that you won't be disappointed if you choose Evesham Micros.



**AMIGA  
SPECIAL  
DEALS**

Our A500 Packages also include the following:

Karate Kid II	Jaws	Wordwright (w processor)	Super Huey
Leatherneck	Defcon 5	Nigel Mansell's Grand Prix	Goldrunner
Battle Squadron	High Steel	Better Dead than Alien	Night Walk

Amiga 500 512K Screen Gems pack including 'Back to the Future 2', 'Night Breed', 'The Beast 2', 'Deluxe Paint 2', Days of Thunder' and TV modulator ..... £379.00  
 Amiga 500 1Mb Screen Gems pack upgraded to a full 1Mb using our 512K RAM/Clock ..... £409.00  
 Amiga 500 Screen Gems pack with Drive includes our high quality 3 1/2" External Drive ..... £430.00  
 Amiga 500 1Mb Screen Gems pack with Drive features our 512K RAM/Clock Upgrade plus our 2nd 3 1/2" External Drive ..... £465.00

Vidi-Amiga video digitiser package ..... £95.00	Phillips CM8833 colour monitor inc.cable ..... £249.00
Vidi-Chrome colour accessory for Vidi-Amiga ..... £16.00	Kickstart 1.3 Upgrade pack ..... £29.95
MiniGEN Genlock Adapter ..... £95.00	AMOS Game Creator ..... £37.50
Contriver Hi-Res replacement Mouse package ..... £22.95	Music-X incredibly powerful music package ..... £129.00
Naksha Hi-Res replacement Mouse package ..... £28.95	Home Accounts (Digita) ..... £18.95
Kraft Trackball (plugs into mouse/joystick port) .. £44.95	Amiga 500 dust cover ..... £4.95

## CBM A590 HARD DRIVE

Good quality Commodore 20Mb Hard Disk, including its own PSU and built-in cooling fan. Features sockets for up to 2Mb of RAM expansion (see below). Autoboos when used with Kickstart 1.3.

A590 (20Mb) only £379.00  
 40Mb version only £499.00

A590 512K RAM Upgrade kit ..... £31.95  
 A590 1Mb RAM Upgrade kit ..... £59.95  
 A590 2Mb RAM Upgrade kit ..... £99.95  
 RAM upgrades fitted free when bought with A590.

Genuine replacement Commodore Amiga PSU .. £39.95

## A500 SOLDERLESS RAM UPGRADES

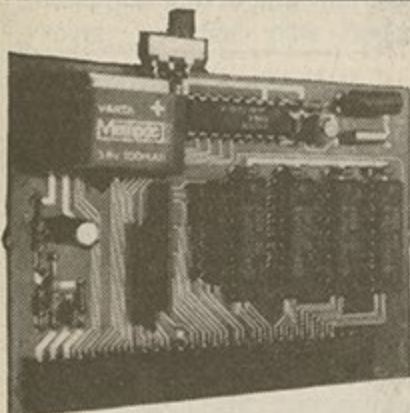

# 512K MEMORY UPGRADE

**ONLY £37.95**  
 including VAT & delivery

### 512K RAM/CLOCK EXPANSION FEATURES:

- ☆ Direct replacement for the A501 expansion
- ☆ Convenient On / Off Memory Switch
- ☆ Auto-recharging battery backed Real-time Clock
- ☆ Compact unit size : Ultra-neat design
- ☆ Only 4 low power consumption FASTRAMs

512K RAM expansion without clock only £32.95

## NEW! 1.5MB RAM BOARD

- ☆ Fully populated board increases total RAM to 2MB!
- ☆ Plugs into the trapdoor expansion (as with 512K unit)
- ☆ Auto-recharging Battery Backed Real-Time Clock
- ☆ Socketed FASTRAM ICs for accommodation up to 1.5MB

Unpopulated RAM Expansion Board with Clock ..... £39.95  
 RAM Board with Clock, with 512K FASTRAM installed ..... £64.95  
 RAM Board with Clock, with 1 Mb FASTRAM installed ..... £84.95  
 RAM Board with Clock, with full 1.5 Mb FASTRAM installed .... £99.95

N.B. Requires Kickstart 1.3 to operate - Kickstart 1.3 Upgrade available from us for £29.95

## SPECIAL NEW AMIGA PRODUCTS

**MIDI  
INTERFACE**  
 Only £19.95

### GET CONNECTED!

Our new fully compatible, high quality MIDI interface connects directly with the Amiga serial port and provides IN, OUT and THRU ports for good flexibility. Features LED indicators on each port to assist ease of use and also for diagnostic purposes. Superb compact design.

**'TESSA'  
speaker system**  
 Only £34.95

### HEAR THAT STEREO!

Your Amiga produces excellent quality hi-fi stereo sound. Enjoy high quality, stereo sound reproduction to the full with our great new twin speaker system, TESSA (twin ergonomic stereo speakers, amplified). Incorporates a specially designed, quality 2.5 watt per channel amplifier, including volume control, to obtain the best sound.

**STEREO SOUND  
SAMPLER**  
 Only £29.95

### S-S-SAMPLE THIS!

Offering full compatibility with almost any Amiga audio digitiser software, our Sound Sampler features excellent circuitry, yielding professional results. The main A/D converter gives a digitising resolution of up to 50KHz, with a fast slew rate. Two phono sockets are provided for stereo line input, plus an option for microphone. Adjustable gain is achieved with built-in control knob. Complete with public domain disk containing sound sampling applications/utilities.

## Amiga & ST 3 1/2" Drives



- Very quiet
- Slimline design
- Cooling Vents
- Sleek, high quality metal casing
- Quality Teac / Citizen mechanism
- On / Off switch on rear of drive
- Throughport connector (Amiga)
- External plug-in PSU (Atari ST)
- Full 1Mb unformatted capacity
- Long reach connection cable

**ATARI ST VERSION :**  
**£64.95**  
**AMIGA VERSION :**  
**£59.95**

5 1/4" External 40/80 Track Drive also available, only £99.00

## PHILIPS 15" FST TV / Monitor (MODEL 2530)

With its dedicated monitor input, this model combines the advantages of a high quality medium resolution monitor with the convenience of remote control Teletext TV - at an excellent low price!

**£269.00**

Includes VAT, delivery and computer connection lead



NEW

# SOLDERLESS MEMORY UPGRADES FOR ANY ST

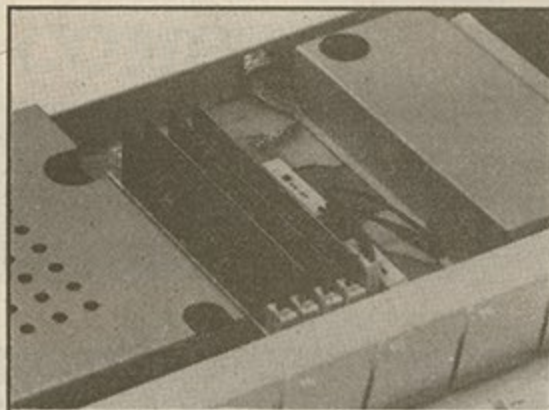

- ✓ Fits Any pre-STE Machine in Minutes !
- ✓ Uses SIMMS RAM Modules for Effortless Upgradeability
- ✓ Probably the Neatest ST RAM Upgrade available !

Upgrade the memory of your ST quickly and easily with our new, fully software compatible RAM upgrade board. Designed for pre-STE machines, the unit accepts SIMMS slot-in memory modules, making RAM fitting simplicity itself. *No soldering required! No electronics knowledge needed!* Available with or without RAM modules. Allows upgrade in stages of 1Mb, 2.5Mb and 4Mb, as and when necessary. Straightforward installation - full instructions provided.

RAM Upgrade Kit with board unpopulated .....	£59.95
RAM Upgrade Kit With 512K RAM installed: upgrades a 520 ST to total of 1Mb RAM .....	£89.95
RAM Upgrade Kit With 2Mb RAM installed: upgrades a 520 / 1040 Mega ST1 to 2.5Mb ....	£174.95
RAM Upgrade Kit With 4Mb RAM installed: upgrades a 520 / 1040 / Mega ST1 to 4Mb .....	£284.95

N.B. Due to the large variance in design of the Atari ST, there is a small minority of boards in existence which may require a small amount of soldering.

## NEW! PLUG-IN, SOLDERLESS 512K RAM UPGRADE FOR ANY ATARI 520 ST

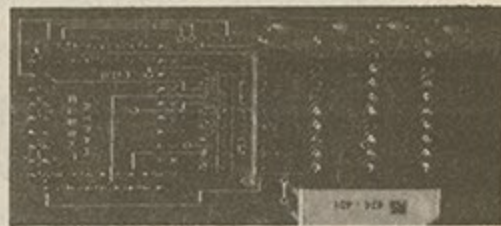

Now there is a simpler, faster and more effective method of upgrading your humble 520 ST to 1Mb RAM ! Our new plug-in 512K memory upgrade unit offers excellent value for money, requiring no soldering or special technical know-how. (Not suitable for STE machines.)

**ONLY £69.95** including VAT and delivery



All our ST prices include: mouse etc. plus 5 disks of software including First Word wordprocessor, utilities, Neochrome graphics utility, game and demos.

### 520 STFM DISCOVERY PACK

Good quality, good value package based around the 520STFM computer including 512K RAM, 1Mb Drive and built-in TV modulator. Also supplied is:

- |                   |               |
|-------------------|---------------|
| STOS Game Creator | Outrun        |
| Carrier Command   | Bomb Jack     |
| Space Harrier     | Neochrome     |
| FirST BASIC       | Atari ST Tour |
- plus 'Discovering your Atari ST' Book

**£259.00**  
Including VAT and delivery

### 1040 STE PROFESSIONAL PACK

Excellent starter package, including the very latest 1040STE machine with 1Mb RAM, 1Mb Drive, plus the following extras :

- |                        |                           |
|------------------------|---------------------------|
| Kuma Wordprocessor     | STAC Adventure Creator    |
| Kuma Database          | Hyper Paint (STE version) |
| Kuma Spreadsheet       | FirST BASIC               |
| Kuma Business Graphics | 'Prince' game             |

**£429.00**  
Including VAT and delivery

### NEW! 520 STE TURBO PACK

Features the latest 520STE with 1Mb drive, joystick, mouse, user guide, 5 disks of public domain software, plus a high quality selection of entertainment and creativity software, including :

- |                                  |             |
|----------------------------------|-------------|
| Indiana Jones & the Last Crusade | Blood Money |
| Impossible Mission II            | Super Cycle |
| Human Killing Machine            | Out Run     |
| Dragons Breath                   | Anarchy     |
| Hyper Paint 2 (STE version)      | FirST BASIC |
| Music Maker 2 (STE version)      | STOS        |

**£339.00**  
Inc. VAT & Delivery

520 STE RAM upgrade to 1Mb, includes 2x256K SIMMS modules .....	£40.00
520 / 1040 STE RAM upgrade to 2Mb, includes 2x1Mb SIMMS modules ....	£119.00
520 / 1040 STE RAM upgrade to 4Mb, includes 4x1Mb SIMMS modules ....	£235.00
520STFM 1Mb Drive Upgrade Kit with full fitting instructions .....	£54.95
520STFM 1Mb Memory Upgrade Kit, requires soldering .....	£59.00
Mega ST1 with monochrome monitor .....	£599.00
Mega ST2 with monochrome monitor .....	£849.00
Mega ST4 with monochrome monitor .....	£1099.00
SM124 monochrome monitor .....	£99.00
SC1224 colour monitor .....	£279.00
Philips CM8833 14" colour monitor (stereo sound) c/w ST cable .....	£249.00
Vidi-ST 16-tone video frame grabber inc. digitising software .....	£89.00
NeoDesk V3 Desktop replacement .....	£29.95

## PRINTERS

All prices include VAT, delivery and cable



**EVESHAM MICROS SPECIAL OFFER - ALL STAR PRINTERS INCLUDE 12 MONTHS ON-SITE MAINTENANCE!**

Star LC10 best-selling 144/36cps printer, 4 NLQ fonts .....	£159.00
Star LC200 NEW replaces LC10 Colour model, with new features: 180/45cps with bottom feed facility and push/pull tractors .....	£209.00
Star LC15 wide carriage version of LC10 .....	£329.00
Star LC24-10 feature-packed multifont 24 pin printer .....	£239.00
Star LC24-15 wide carriage version of LC24-10 .....	£409.00
Star LC24-200 NEW updated ver. of LC24-10 with bottom feed facility, push/pull tractors and a print speed increase to 200/67cps .....	£249.00
Star LC24-200 NEW 7-colour version of LC24-200, excellent value .....	£289.00
Star FR-10 Professional 9pin 300/76 cps, 31K buffer, 16 NLQ fonts, EE-PROM configuration memory and 12 months on-site maintenance .....	£399.00
Star FR-15 9pin as FR10, wide carriage version .....	£499.00
Star XB24-10 Professional 24 pin: 27K buffer, 4 SLQ & 25 LQ fonts with EE-PROM configuration memory and 12 months on-site maintenance .....	£499.00
Star XB24-15 wide carriage version of XB24-10, with 41K buffer .....	£649.00
Hewlett Packard Deskjet Plus 300dpi Inkjet printer - while stocks last ! .....	£399.00
NEC P2+ budget 24pin, special low price ! .....	£239.00
Panasonic KXP1180 super 9pin with over 3400 typestyles, 11" carriage .....	£179.00
Panasonic KXP1124 good quality 11" multifont 24pin printer .....	£269.00
Panasonic KXP1624 wide carriage version of KXP1124 .....	£399.00
Epson LX400 popular 10" 180/25 cps .....	£159.00
Epson LQ550 good 24pin printer 150/50 cps .....	£349.00

## Western Digital Filecards

Upgrading your PC to hard disk? Look no further, we offer the best prices on top quality filecards, with ultra-competitive speed ratings. Thorough documentation supplied, low power consumption, with free XTree file management software and Speedread. For Amstrad PC 1512/1640/2086 users we supply filecards tested and formatted, with our simple software installation procedure. Probably the best packages available!

**21MB...£225.00 32MB...£239.00 41MB...£279.00**

**ATARI AMSTRAD**

Buying a PC? Shopping around for the best deal? Evesham Micros is one of the UK's leading suppliers of Olivetti, Amstrad, Sharp and Atari PC's, offering highly competitive deals at the lowest prices. Contact us now for a quote!

**OLIVETTI SHARP**

# Evesham Micros

RETAIL SHOWROOMS

63 Bridge Street  
Evesham  
Worcs WR11 4SF  
☎ 0386-765180  
fax: 0386-49761  
Open Mon - Sat, 9.00 - 5.30

5 Glisson Road  
Cambridge CB1 2HA  
☎ 0223-323898  
fax: 0223-322883  
Open Mon - Sat, 9.30 - 6.00  
Specialist Education Centre

1762 Pershore Road  
Cottrelidge  
Birmingham B30 3BH  
☎ 021-458 4564  
fax: 021-433 3825  
Open Mon - Sat, 9.00 - 5.30

**ALL PRICES INCLUDE VAT AND DELIVERY**  
Same day despatch whenever possible. Express Courier delivery £5.00 extra.

MAIL ORDER DEPARTMENT

Unit 9 St Richards Rd, Evesham, Worcs WR11 6XJ



Call us now on ☎ 0386-765500  
8 lines, Open Mon - Sat, 9.00 - 5.30. Fax: 0386-765354  
Technical support (open Mon - Fri, 9.30 - 5.30): 0386-40303



Send an Order with Cheque, Postal Order or ACCESS/VISA card details. Allow 10 days personal cheque clearance.

Government, Education & PLC orders welcome  
All products covered by 12 Months Warranty  
All goods subject to availability, E. & O.E.

# COMPUTER AUCTIONS

Presented by...

## TRADERDESK

**BIRMINGHAM 10TH NOVEMBER 1990**

**BARNSELEY 24TH NOVEMBER**

at **The National Motorcycle Museum**  
by the N.E.C. of Junction 3 of the M42 or  
Junction 4 of the M6, Birmingham

at the **Metrodome**  
Queens Ground, Queens Road, Barnsley  
(please phone for possible change of venue)

Viewing 9.00am to 11.00 when the sale will start

Viewing 9.00am to 11.00 when the sale will start

AUCTION CATALOGUES ARE AVAILABLE FROM OUR OFFICES THE MONDAY BEFORE ANY AUCTION AT A COST OF £1. OUR ANNUAL SUBSCRIPTION HOWEVER OFFERS A MINIMUM OF 23 CATALOGUES FOR A COST OF ONLY £12. PHONE EITHER CHRIS PAGE OR DAVE GARVEY ON EITHER OF THE NUMBERS BELOW WITH YOUR ACCESS OR VISA NUMBER OR SEND US A CHEQUE OR POSTAL ORDER

**0527 579120**

TO ENSURE YOU RECEIVE  
YOUR CATALOGUE  
POSTAL BIDS ACCEPTED.

**0934 612011**

**ATARI ST ★ ATARI ST ★ ATARI ST ★ ATARI ST ★ ATARI**

**A brilliant offer for readers of New Computer Express!**

## Devpac ST 2

**FROM HISOFT ONLY £44.95**

Devpac ST Version 2 is widely regarded as the most powerful assembly language development system for the Atari ST. It incorporates a debugger, stand-alone assembler and a fast linker

### IT INCLUDES:

- ▶ **GenST** Assembler is a high-performance, full-featured, two-pass Motorola standard macro assembler at up to 75,000 lines per minute. It has multiple modules and sections, repeat loops and macro calls that maybe nested as deeply as memory allows.
- ▶ **MonST** Debugger is an advanced symbolic monitor, debugger and disassembler. Now in addition it can offer Multiple window display, full expression evaluator, up to 22 significant characters in symbols, viewing of source files and conditional breakpoints.
- ▶ **Example Files** of a wide variety including a full GEM type windowing application and an example desk accessory.

The package comes complete with an extensive ring-bound manual plus notes on the various operating system levels and debugging strategies.

Order now by phone from the NCE mail order service or send the coupon to our FREEPOST address.

**HOTLINE NUMBER 0458 74011**

**DevpacST 2**  
version 2

Complete Assembler/Debugger System  
for the Atari ST Computers

**SAVE  
£15**

Yes, I would like to order a copy of  
Devpac ST 2

Name \_\_\_\_\_

Address \_\_\_\_\_

Tel No \_\_\_\_\_

I would like to pay by **Access Visa**  
**Cheque PO**

Please debit my credit card  
No \_\_\_\_\_

Expiry Date \_\_\_\_\_

Tel. No \_\_\_\_\_

Send & make cheques payable to  
Future Publishing, FREEPOST, The Old  
Barn, SOMERTON, Somerset. TA11 7BR

# MCD

## COMPUTER AUCTIONS

### FOR SALE BY AUCTION

**SATURDAY 27th OCTOBER**  
**SATURDAY 17th NOVEMBER**  
**SATURDAY 8th DECEMBER**  
**1990**

St Pauls School  
The Ridings  
Green Street

Sunbury-on-Thames, Middx  
(1/2 mile from junction 1 of M3)

Wide selection of up to date PC's,  
printers and software

Phone **0276 692260** for details

## ABTEK SYSTEMS

**SPECIALISTS IN NEW AND USED  
IBM COMPATIBLE SYSTEMS**

National Distributors of Touchmate  
386 VGA colour systems

"One of the most competitively priced units in Britain"

CHRISTMAS

**2nd USER**

SPECIALS

**HOME STARTER KIT**

Amstrad 1512 - 20 Mb Hard Disk colour monitor  
complete with joystick & games software starter pack

£475 + VAT

## ABTEK COMPUTER AUCTIONS

SPECIALIST AND PUBLIC AUCTIONEERS

FORTHCOMING AUCTIONS:-

**SWINDON**

Saturday 3rd November  
New College Helston Rd

**KEMPTON PARK**

Saturday 24th November  
Kempton Pk Racecourse, Sunbury

Viewing 8.30 Auctions starts 11.00  
FOR FULL DETAILS CALL ABTEK SALES

**0722 413337**

ABTEK SYSTEMS LTD, The Gateway,  
38 Sarum Business Park,  
Portway, Salisbury SP4 6EA

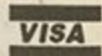

## CITY COMPUTER AUCTIONS



# AUCTION

of Computers and related products.

**14th November 1990**

Unit 4, Gales Gardens Mews, London E1



1000 Lots of new and used microcomputers and peripherals  
inc IBM and compatible systems, PS/2 range, Compaq,  
Tandon, Toshiba etc, Laser Printers, Portables, Late-Edition  
Software and Consumables.

**Viewing and Testing**

**Wednesday 13th November & evening of sale**

**FOR FURTHER DETAILS AND CATALOGUE PLEASE CONTACT**

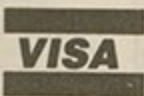

**071-729 7669**

Refreshments  
Available

**Specialists in New and Second User Systems**





**EMULATE.** For Amiga, Amex. With monthly newsletter. Write to Pat 12b Northbrooks, Halrow, N Essex

**ENTERPRISE** - Tim Box, Independent Enterprise User Group, 50 Holdenhurst Avenue, Finchley, London N12 0HX. 081-346 8032

**FLIGHT SIMULATOR (MSDOS)** - Alan Hawkins, SIMFLY Club 2 Henley Manor Raincliffe Ave, Scarborough YO12 5BU

**FORTH Language** - Douglas Neale, FIG (Forth Interest Group) UK, 58 Woodland Way, Morden, Surrey SM4 4DS.

**FRACTALS/CHAOS THEORY** - Andy Lunness, 69 Bronte Avenue, Bury, Lancs BL9 9RN. 061-764 6469

**GENEALOGISTS** - Computer Group, Society of Genealogists, 14 Charterhouse Buildings, London EC1M 7BA. 071-251 8799.

**GENERAL HOME MICROS** - Steve Winter, Chic Computer Club, PO BOX 121, Gerrards Cross, Bucks SL9 9JP 0753 884473

**HITACHI MBE 16002 PC** - Bruce Ainge HICUPS 16 Nine Acres Road, Cuxton, Kent ME2 1EL. 0634 715759

**HOUSING ASSOCIATIONS** - Caroline Maries, Micro Users Ltd, Beaver Housing society, 23 Lewisham High Street, London SE13 5AF. 081-318 1126

**IBM PC** - The IBM PC User Group PO BOX 360 Harrow HA1 4LQ.081-863 1191 BBS 081-863 6646

**JUPITER ACE** - John Charter, Jupiter Ace Forth User Group, 17 Spring Wood Close, Dunston, Chesterfield S41 8BS. 0246 237555 SAE

**LOTUS PRODUCTS** - Lotus User Group, 79-80 Peascod St, Windsor, Berks SL4 1DH. 0753 841686

**LYNX** - R B Jones, Lynx User Group, 39 Ash-ton Close, Needingworth, St Ives, Cambs

**LYNX DISK USER GROUP.** J Koushapas. 172 Pasteur Gdns, London N18. Tel: 081 807 3859

**MEMOTECH** - Phil Eyres - Memotech Owners Club, 23 Denmead Road, Harefield, Southampton SO2 5GS .0703 585106

**MICROSOFT WORD** - Lesley Port, Microsoft Word User Group, Folly House, Madeira Walk, Bachelors Acre, Windsor, Berks SL4 1EU. 0753 831001

**MOTOROLA 68xxx MICROS** - Rick Apple-gate, 68 Microgroup, 8 Great Cob, Spring-field, Chelmsford, Essex. BBS 081-316 7402

**MSX SYSTEMS** - Keith Neal, MSX Link, Austerby House, 80 Austerby, Bourne, Lincs PE10 9JL

**NASCOM/80-BUS/CPM** - Scorpio Systems, PO BOX 286, AYLESBURY, BUCKS HP22 6PU. 0296 624868

**NEWBRAIN** - Ron Bury, NewBrain Support Grp, 70 Cranberry Lane, Darwen, Lancs BB3 2HL 0254 771891

**NIMBUS/RM AX/VX** - Dr Martin Hatfield NIM-BUG, 13 Belle Vue Ave, Gosforth, Newcastle-upon-Tyne NE3 1AH 091-285 7806

**NORTHSTAR** - Brian Haines, North Star & CP/M Grp, 9a Sharpleshall St, London NW1 8YN.

**OS/2** - Karen Burns, OS/2 User Group, Cecily Hill Castle, Cirencester, Glos LG7 2EF 0285 655 888

**OSBORNE/CPM/MSDOS** - Jeremy Browne BOOG, 102a Aldershot Road, Fleet, Hants GU13 9NY. 0252 621745 voice, 626233 BBS

**PC SOFTWARE** - PC Serve, 1147 Green-ford Rd, Greenford, Middx UB6 ODP 081-864 2611, BBS 081-864 2633

**PRESTEL** - Andy Leeder, ClubSpot 810, Church Farm, Stratton St Michael,

Norwich, NRQ15 2QB

**PSION ORGANISER** - Mike O'Regan, IPSO, 130 Stapleford Ln, Beeston, Nottingham NG9 6GB. 0602 735482

**RESEARCH MACHINES** - Steve Rochford RM National User Group, George Stephenson High School, Southgate, Killingworth, Newcastle NE12 0SA. 091-268 2002

**SANYO MBC-550** - M H Syed, Wistaria, 53 Acacia Grove, New Malden, Surrey KT3 3BP. 081-942 9009

**SCHNEIDER EURO PC** - Alex Kefford, SEPUG, 11 Crabbet Road, Three Bridges, Crawley, West Sussex RH10 1NF

**SHARP** - Andrew Ferguson, Sharp User Go, 11 Harcourt Close, Henley on Thames, Oxon RG9 1UZ. 0491 574850

**SIRIUS** - Simon Sheppard, ISSUE PO BOX 222, Brighton BN1 3BR.

**SORD M-23 B Nicholson**, Schlumberger Norge A/S Bjergstedveien, 4007 Stavanger, Norway. 474 657002.

**TANDY/MSDOS** - Roger Storrs, NATGUG Oakfield Edge, Ram Hill, Coalpit Heath, Bristol BS12 2TY. 0454 772 920

**TEXAS T199/4a** - Peter Walker, T199/4a User Gp UK, 24 Bacons Drive, Cuffley, Potters Bar, Herts EN6 4DU. 0707 873778

**TRANSPUTER** - Howard Oakley, Transputer User Group, Brooklands Lodge, Park View Close, Wroxall, Ventnor, Isle of Wight

**UNIX USERS** - UKUUG Secretariat Owles Hall, Buntingford, Herts, SG9 9PL. 0763 73039 /73255 (fax)

**VENTURA PUBLISHING** - VPU (Ventura Publisher User grp) Linda Liddell VPU c/o LLA Lound House, Fornsett St Mary, Norfolk, NR16 1JP. 0508 41580

**WORDPERFECT** - Michael Norman, Word-perfect User Group (UK) Dove Barn, Manor Farm, Wootton Woodstock, Oxon, OX7 1DX 0993 812 670.

**PICK OPERATING SYSTEM** - Hugh Kellit, UK Pick Users Assocn, PO BOX 907, London N10 2SB. 081-462 4666

**R:BASE** - Mrs Tansy Beal, R:Base User Group c/o Room A2044 BBC Woodlands, 80 Woods Lane, London, W12 0TT. 081-576 7187

**REVELATION (PICK)** - Malcolm Frame UK Revelation User Gp, 136 St Albans Road, Watford WD2 4AE. 0923 35515

**SMART SYSTEMS USERS** - Francis Barton, smart User Group, Basement Holy Rosary church, Louis Street, Chapelton, Leeds LS7 4BP. 0532 629202

**SUPERPROJECT** - Geoff Groom, 3 Sun-nymeade Ave, Carshalton Beeches, Surrey, SM5 4JA. 081-643 3336

**TAS (DATABASE)** - Neil Hegarty, TASUG C/O Solutions for You, 1st Floor, 2 Lytton Rd, New Barnet, Herts EN5 5BY. 081-441 1133, BBS 081-449 4171

**UNIX USERS** - UKUUG Secretariat Owles Hall, Buntingford, Herts, SG9 9PL. 0763 73039 /73255 (fax)

**VENTURA PUBLISHING** - VPU (Ventura Publisher User grp) Linda Liddell VPU c/o LLA Lound House, Fornsett St Mary, Norfolk, NR16 1JP. 0508 41580

**TANDY/MS-DOS** - Roger Storrs, NATGUG Oakfield Edge, Ram Hill, Coalpit Heath, Bristol BS12 2TY. 0454 772 920

**TEXAS T199/4a** - Peter Walker, T199/4a User Gp UK, 24 Bacons Drive, Cuffley, Potters Bar, Herts EN6 4DU. 0707 873778

**TEXAS T199/4a** - Peter Brooks, International TI User Group 96 Banbury road, Oxford OX2 6JT. 0865 510822

**TRANSPUTER** - Howard Oakley, Transputer User Group, Brooklands Lodge, Park View Close, Wroxall, Ventnor, Isle of Wight PO38 3EQ

## Local Clubs

**FIND YOUR LOCAL CLUB** - John Dale, british Association of Computer Clubs, Banc y rhosyn, 14 Bron Y Glyn, Bronwydd Arms, Carmarthen SA33 6JB. 0267 230 771

## Amstrad

**AMSTRAD 1512/1640/PPC** - PC Independent User Group, The Computer Advice Centre 87 High Street, Tonbridge, Kent TN9 1RX 0732 771 512

**AMSTRAD BUSINESS USRS** - Amstrad Professional User Club, enterprise House PO BOX 10, Roper St, Pallion Ind Estate, Sunderland SR4 6SN. 091-510 8787

**AMSTRAD CPC USERS** - Tony Baker, United Amstrad User Gp, 26 Uplands Crescent, Fareham, Hants PO16 7JY 0329 234 291

**AMST. CPC HOME USERS** - Steve Williams, WACCI, 9 South Close, Twickenham TW2 5JE. 081-898 1090

**AMSTRAD LOCAL GROUPS** - Amstrad Groups Federation, 4 Sutton Roadc, Gorton, Manchester M18 7PN

**AMSTRAD PC SOFTWARE** - Colin Smith, COLBAR, 10 Penwood cl, Westbury, Wilts BA13 3LW

**AMSTRAD PCW** - PD software: Bob Ellis 0432 761860 Queries: David Axford 0428 56438

**AMSTRAD PCW** - Bob Ellis "Rowan" 100 St Peters Close, Moreton-on-Lugg, Hereford HR4 8DW. 0432 761 860

## Software/Networks

**ASHTON TATE SOFTWARE** - Silvia Robinson, Baseline, Ashton-Tate, 1 Bath Road, Maidenhead, Berts 0628 33 123. Prestel page 43221

**ATARI ST SOFTWARE** - 16/32 PD library 35 Northcote Road, Strood, Kent ME2 2DH

**C LANGUAGE** - Martin Houston CUG (UK) Houston Technology Ltd, 14 Arden Oak Rd, Sheldon Birmingham BS26 3LX 021-722 3168

**COBOL LANGUAGE** - Allen Reavie 22 Mourneview St, Portadown, Northern Ireland. BT62 3AW,

**COMPUNET** - Independent Compunet Club, 148 Furzehill road, Boreham Wood Herts. WD6 2DX

**CPM & MS-DOS USERS** - Nicholas Higgins CPM & MSDOS Users Group, 42 Birkbeck Road, Wimbeldon, London SW19 9NZ. 081-543 0824

**DATAEASE** - Dataease User Group Hi-tech House, 10 Blackfriars St, Norwich NR3 1SF 0603 762 806

**ECONET** - Michael Ryan, Econet User Gp, Balkeerie Cottage, Eassie by Forfar, Angus DD8 1SR

**ENET (like econet)** - T K Boyd, Enet (Amcom) User Gp, Seaford Cottage, Petworth, West Sussex GU28 0NB

**WORDPERFECT** - Michael Norman, Word-perfect User Group (UK) Dove Barn, Manor

Farm, Wootton Woodstock, Oxon, OX7 1DX 0993 812 670

**WORDPERFECT** - Dr Ian Barton, A Perfect World, High Rigg, Alma Rd, Tideswell, Derbys SK17 8LS 0298 871 925

## Special Interest

**AMATEUR RADIO (CBM)** - Simon Lewis GM4PLM Commodore Radio Usrs Gp, 69 Irvine Drive, North Clippens, Linwood, Paisley PA3 3TB

**AMATEUR RADIO 9COMMS0** - Pat & John Beedie GW6MOJ/MOK BARTG Flynnonlas Salem, Llandeilo, Wales SA19 7NP. 0558 822 286 MBX 558 822 286

**ARABIC COMPUTING** - Rich Lackey, Arabits, 9 Bellview road, Worthing, West Sussex BN13 1EY

**CD ROM** - UK CD-ROM User Group, High Wings, Salem, Treforys, Abertawe SA6 1XX 0792 844 370

**CHURCH ADMINISTRATION** - Rev Stoker Wilson, Church Computer User Gp, St John's Vicarage, Greenside, Ryton, Tyne & Wear NE40 4AA. 091-413 8281

**CLARGY/MEDICAL EDUCATN** - Mr T Jones, FREE-ED Shareware/PD 85 Stoke road, Taunton, Somerset TA1 3EL. 0823 321 481

**COMMUNITY COMPUTING** - Community Computing Network 2nd Floor, 35 Pink Lane, Newcastle, NE1 5DW 091-261 0317

**CONFERENCING** - Compulink, suite 2, The Scantuary, 23 Oakhill Grove, Surbiton, Surrey KT6 6DU Voice 081-390 8446 CIX BBS 081-399 5252

**CRYPTOGRAPHY & CODES** - Mike Barlow, American Cryptogram Association 5052 Chestnut Avenue Pierrefonds, Quebec HBZ 2A8 Canada

**DISABLED** - Jeff Hughes, Special Needs User Gp, 39 Eccleston Gardens, St Helens WA10 3BJ 0744 24608

**EDUCATION** - Charles Shannon, TECUG, 35 Wellington St, Gravesend, Kent DA12 1JG. 0474 567 931

**FLIGHT SIMULATOR (MSDOS)** - Alan Hawkins, SIMFLY Club 2 Henley Manor Raincliffe Ave, Scarborough YO12 5BU

**FRACTALS/CHAOS THEORY** - Andy Lunness, 69 Bronte Avenue, Bury, Lancs BL9 9RN. 061-764 6469

**GENEALOGISTS** - Computer Group, Society of Genealogists, 14 Charterhouse Buildings, London EC1M 7BA. 071-251 8799.

**HEALTH WORKERS** - Sue Mckendrick, Healthlink, 164 Windsor Rd, Ashton-in-Makerfield, Wigan WN4 9ES. Voice: 0942 712 385

**HOUSING ASSOCIATIONS** - Caroline Maries, Micro Users Ltd, Beaver Housing society, 23 Lewisham High Street, London SE13 5AF. 081-318 1126

**LOCAL AUTHORITIES** - Local Authority Micro User Gp, John New, Borough Engineer's Dept, Municipal Offices, North Quay, Weymouth, Dorset DT4 8TA. 0305 785101 x272

**PHILOSOPHY APPLE** - G Haines, Chinese Room Club, 43 Cornwallis Gdns, Hastings, East Sussex TN34 1LX. 0424 714 102

**PRESTEL** - Andy Leeder, ClubSpot 810, Church Farm, Stratton St Michael, Norwich, NRQ15 2QB

**SERVICES USERS** - Sqn Ldr G Howson, Services Personal Computer Association, Stik Eng 15a HQSTC RAF High Wycombe, Bucks

**SCIENTIFIC PC USERS** - Tim Bunning, SPCUG PO BOX 17, Retford, Notts DN22 6BQ 0777 709 009



# SECOND HAND BARGAINS

Welcome to the first in a regular monthly round-up of second hand prices for hardware, gleaned from the pages of *Shopping Express*.

Hopefully you will find this monthly round-up of great use for finding out what you should expect to pay for a particular machine, but there are a few points to bear in mind:

- The lower priced products are usually accompanied by the words in the ad: "Some repair work necessary."
- The higher priced computers are invariably as part of a package including numerous add-ons - anything from printers to laser guns - and mountains of software.
- Accessories are advertised not nearly so often on their own as the computers - they are usually offered as part of a package. When they are so sold, prices vary so dramatically, that attempting to evaluate an average is unrealistic.
- Remember that this is only a guide, so if you find a PC for £20 down your local market, bully for you.

## AUCTION STATIONS

### The November Auction Round-Up

Once a month, *Express* will be presenting a diary of auctions up and down the country. So if you run auctions anywhere, or know of any coming up in your area, please contact us with details so that we can make this

	Range	Average:
SPECTRUM:	£40-95	£70
SPECTRUM PLUS TWO:	£70-550	£140
SPECTRUM PLUS THREE:	£100-250	£200
CPC 464:	£100-900	£170
6128:	£125-650	£250
PCW 8256:	£250-350	£300
8512:	£250-450	£325
AMSTRAD PRINTERS:	£40-350	£150
ATARI 520 STFM:	£150-650	£350
1040 STFM:	£300-600	£400
ST	£200-400	£250
800XL:	£60-160	£125
AMIGA 500:	£295-850	£450
COMMODORE 64:	£60-500	£250
QL:	£50-295	£120
SEGA:	£80-280	£200
SEGA MEGA:	£100-170	£150
PC ENGINE	£95-185	£160

listing as comprehensive as possible.

### SOUTH EAST

Abtek (0722 413337)

3 November - New College, Helstone Road, Swindon

24 November - Kempton Park Race Course

Please phone for further details.

CEAC (071 738 2400)

27 October - Decorum College, Hemel Hempstead, Herts. Viewing 9am-10.30am, sale starts 10.30am

2 November - CEAC Offices, 8 Grant Road, Clapham Junction, SW11. Viewing 12 noon-8pm on Thursday 1st and 12 noon-5pm on Friday 2nd. Sale starts at 6pm.

10 November - CEAC Offices, 8 Grant Road, Clapham Junction, SW11. Viewing 9.30am-10.30am, sale starts 11am.

16 November - CEAC Offices, 8 Grant Road, Clapham Junction, SW11. Viewing 12 noon-8pm on Thursday 15th and 12 noon-5pm Friday 16th. Sale starts 6pm.

24 November - Kempton Park Race Course, Surrey. Viewing 9.30am-10.30am, sale starts 10.30am

London Computer Auction Rooms (071 794 1116)

2 October - Hackney Free School, Paragon Road, London. Viewing from 8.30am, sale starts 11am

10 November - Barnet College, Barnet. Viewing from 8.30am, sale starts 11am. Please phone for further details.

MCD (0276 692260)

17 November - St Paul's School, Sunbury-On-Thames. Please phone for further details.

Technology Computer Services (081 651 3639)

27 October - Ravenswood School, Oakley Road, Bromley, Kent. Viewing 9am, sale starts 10.30am

10 November - Kemnal Manor School, Sevenoaks

Way, Orpington, Kent. Viewing 9am, sale starts 10.30am.

24 November - Ravenswood School, Oakley Road, Bromley, Kent. Viewing 9.00am, sale starts 10.30am

### SOUTH WEST

Traderdesk (0527 579120)

27 October - BAWA Leisure Centre, 589 Southmeade Road, Filton, Bristol. Please phone for further details.

### MANCHESTER

Computer Connections (0254 813316)

17 November - Bowlers, Old Trafford Cricket Club. Please phone for further details.

### MIDLANDS

Traderdesk (0527 579120)

10 November - National Motorcycle Museum, NEC roundabout. Please phone for further details.

### YORKSHIRE

Traderdesk (0527 579120)

24 November - Metrodome, Queen's Ground, Queen's Road, Barnsley. Please phone for further details.

## BIDDING TIPS

- Prices at auctions can be quite a lot lower than those in shops, but you will have to pay in full on the day, and usually no warranty is given.
- Get a catalogue beforehand.
- Set yourself a limit.
- Give your selected items a good looking over and see if there's a warranty card present.
- Wait for the auctioneer to call the first bid - he'll come right down if no one offers.
- Don't be tempted to outbid over the odds - you might be up against a dealer for whom a bargain is just a higher than normal margin.

## RIGHTING WRONGS

In theory, everything at an auction is sold as seen, but you do have the rights of a secondhand buyer. So the onus is on you to make sure the kit you buy is worth the money you're likely to bid.

Most auctioneers won't mind you opening up machines and having a good look at the contents. As most of the machines are powered up, you can always take along your own software to see if it runs as it should. Take along a benchmark test as well so you can make sure that 386 isn't just a case with a 286 at its heart.

If however, an item doesn't tally with the description in the catalogue, the Sale of Goods Act entitles you to a refund. Unofficially though, most auction companies will refund your money if you buy piece of kit that doesn't work as it should. ■



# TECH TIPS



Does your PC keep packing up? Is your Amiga less than friendly? Would your ST try the patience of a saint? Write to Keith Pomfret's Tech Tips and we'll soon see you right. Send your sorry stories to Tech Tips, Beauford Place, 30 Monmouth Street, Bath BA1 2BW.

## HELP! Screensaver

I read in a book that you can catch cancer from computers and that the common market has stopped it all by law. As I use a computer in the travel shop where I work, I want to know what I can make my firm do so I don't get cancer.

Megan Hrowe, St Leonards

ECJ vol33 (EEC) contains a directive concerning requirements of screen displays for people who use CRTs (monitors) at work. Covered in the directive are radiation, glare, reflection, and screen size.

The directive isn't yet law and in fact it will be a couple of years before the directive is backed by legislation. But during that time employers should be making inroads to ensure that all of their computer equipment complies.

No-one has yet proved that looking at a monitor gives you cancer or any other serious disease. There are lobbies for and against. If you use a computer monitor on a regular basis, you could ask your company to provide an anti-glare/anti-radiation screen. This would make the screen less tiring to look at and reduce some of the electromagnetic radiation.

A trip down the high street to our local travel agent revealed that the monitors they were using had ten inch screens. Rumours about legislation currently planned suggest that screens this small will be banished in a working environment.

## HELP! Between us

Where can I find programs and advice in Arabic. English is my second language and I currently study in the UK, but when my course is finished I would like to be able to take programs back to Saudi with me so that friends there could use and enjoy them. Not everyone has the advantage of English, but the current economic climate in Saudi Arabia means that there is money to buy technology like computers. ??????????? Cambridge University

I haven't put your name at the end of the letter because 1) I couldn't read it and 2) Even if I could, I doubt if Protext or Microsoft Word supports those characters. The people that can probably be of help to you are Arabits (Arabic Computing). I haven't had time to verify this group but it might be worth dropping them a line at 9 Bellview Road Worthing,

West Sussex. However, as the contact name on our list is Rich Lackey, I would check their bona-fides before committing yourself.

## HELP! All by myself

There is many a time when I sit staring blankly at my PC wondering how to climb out of the hole that I, or my software, have dug. After writing down 37 questions and reaching 1500 words in my letter realisation dawned. This was the sort of letter that would be consigned to the bin or taken to the paper aeroplane drawing board.

Instead please accept mark two. The streamlined only One simple question from a confirmed self-starter that will probably be the catalyst to answer all of the others.

Can you recommend a good PC based club or user group that takes the machine seriously and doesn't just exist to copy software?

Joe Rawcliffe, Burnham on Sea

I wish I got more letters like that. Plenty of planning and thought. The chaps and chapes that you require are: The Independent PC User Group who will graft you to their masses for a fiscal trifle. Give them a ring on 0732 771512 and your remaining 36 questions will be solved in a flash.

## HELP! Any old iron!

As part of an upgrading in our computer department, the office mainframe has been changed for something more compact and powerful. Among the parts that weren't salvaged by the company were over 40 reels of half inch computer tape, three punch card reader desks, two line printers and a power supply. They all followed me home one night and have been hiding in my garage since. What should I do with them.

Tony Davenport, Orpington

The reels of computer tape work fine as audio tape if you can find a machine that will take that width. You'll have to spool them onto audio reels, though computer reels don't fit on audio reel to reel players. We tried a couple of reels of computer tape on a half inch multi-track studio machine and were pleasantly surprised. The quality was a bit hissy, but at least it worked. I've no doubt that a dose of

the Dolbys will clean the sound up. We also got the office slave to spend an hour or two winding some of the computer tape on to a video cassette, but there was no success here. Garbled audio reception and no video signal. Still, you can't win them all.

The punch card readers should be encapsulated with dry silica gel and held onto for a hundred years or so. By then, they'll be digital antiques and command a high price in a museum and your successors will be able to reap the benefits of your family philanthropy. Or you could weigh them in as scrap and make a few bob now.

The line printers will only be of any use if you have interface documentation for them and can figure out a way of welding them to something modern and civilised.

You didn't give any details about the power supply so I reserve comment on that one.

## TIP! CPM driving seat

With reference to the letter from I. Keilans from Wirral (Issue 98), I have used the mentioned Nevada Cobol from Hisoft, and I have found no need for two drives. The problem may be from the version of the CPM emulator used. I was given a later version than that supplied by Hisoft which can recognise up to 16 drives.

I therefore installed three ram disks using K-Ram of varying sizes and had no problems except that you have to do an "era \*.\*" to be able to use the drive (don't ask me why). On the problem of formatting, a freshly formatted Atari disk is all you need and then just copy A:<filename> Destination. I was about to sell the Nevada Cobol but if Mr Keilans wishes to purchase it I can be contacted on the phone number below. I also have some other utilities such as Tosdir, which will give you a listing of the Tos disk, and CPMTOS and TOSCPM, which convert or copy files from a tos disk to a cpm disk or vice versa, which Mr Keilans may like to purchase.

Mr A Scott, Preston, Lancs, (0772) 612563

... And as ever, as soon as a Tech Tipper lands in the mire, there are droves of fellow codeheads waiting on the bank ready to throw the rope of salvation. Thanks for a solution and even if Mr Keilans doesn't dial, I'm sure that someone else will be interested. If you've any more bits and bobs to sell, don't forget the free ad service that we offer to all our

readers. As long as an ad isn't illegal, villainous or generally nasty, we will probably run it. However, ads from blatant pirates will be passed straight to the Federation Against Software Theft.

## HELP! Leads please

I have a Novex colour monitor model NC1414-CL with switchable dual inputs ie, Composite/RGB. I use the monitor with a PK 232 TNC for packet, with a CBM 64 on the composite input. Now that I have acquired an Amiga 500 I would like to use the RGB input, but unfortunately I have not been able to obtain a suitable connecting lead or any information on the connections to the eight pin DIN socket on RGB input. I would be pleased if you or any of your readers could help me out.

Len Martin, Birmingham.

No sooner than you ask than we had a delve in Tech Tip's bucket of interesting phone numbers and turned up a couple that may be of use to you.

RSD Connections on 0992 584205  
Connexions (UK) PLC on 0702 72091  
Simpson Electronics on 0332 760353

## HELP! Disk Doctor

Recently I was approached by a friend who asked if I could help out with a disk that a colleague of his seemed to have knackered up. As she works in a busy office she is finding the apparent loss of information worrying.

My friend explained that there are about 38 .DOC files on the disk and that access to 10 or so result in the prompt line display showing: " " (name.doc)" is not a supported file type". One of these files (over 120k) contains customer information vital to her.

When I slammed it through CHKDSK (MS DOS v3.3) I found that I too had problems when so much information came up on the screen. I'll illustrate with one file:

VLJBOOKS>DOC

Allocation error, size adjusted.

100 lost clusters found in 10 chains.

Convert lost chains to files (Y/N)?

VLJBOOKS.DOC

Is cross linked on cluster 99.

In fact, the first three files that came up with "allocation error" were the IBMBIO.COM, IBMDOS.COM and COM-

MAND.COM files. I believe the package she is using is called DisplayWrite 4.  
*David Ross, Durham*

It sounds as if strong medicine is called for. First rule when there is a problem on a floppy disk is make a copy of the corrupt disk if that's at all possible. This way you always have the original to make more copies of if your disk surgery kills the patient. Dead and dying disks with corrupt word processor files can sometimes have the files recovered by attempting to load them into a less fussy word processor or by using a word processor with a file convert utility that turns the affected file into pure ASCII.

It sounds as if you require something much stronger, though. Disk utilities such as Norton Utilities or PC Tools can help with disk and file problems and are very powerful, but can be dangerous in the hands of a careless person. If you wish to use them, be sure that you understand them and their documentation. If you have any qualms about their use, get someone who understands them to watch over your shoulder.

**■ Pic tricks**

My friend owns an Amiga 1000 and an Atari 1040ST. He has some IFF format pictures I would like to use in my art programs. Is it possible to get the IFF pictures to my ST without using the RS232 (null modem etc)? I have heard that the Amiga can read/write MS DOS format disks (which is OK for the ST) with a program called DOS-2-DOS, so maybe this could do the trick?

I'm also looking for penpals, preferably in the London area, who also use Spectre (the Mac emulator) semi-professionally. I can be contacted at the address below.

*Jay Lee, Operalaan 37, 2907 KA, Capelle a/d yssel, The Netherlands.*

Good luck with the penpals - I must point out that I can't be responsible for any gibberish that they may write! As for the IFF pictures, what you have to do is - create an ST disk using DOS-2-DOS on the Amiga. Take the disk to ST and load the file into *Deluxe Paint* or *Degas Future* from Electronic Arts. That should do the trick.

**■ WAH! Off his chest**

I read with amusement the letter you printed by Brian Murray. I think I've met him. He's a bloody idiot. Most of the other people in his company are more intelligent than that.

If you had been more quick-witted you could have quoted his phrase about your 'moral duty' to help him and torn strips off him for having the audacity to mention moral duties in such a letter. I believe he's the same Brian Murray I met in Liverpool.

I'm glad I no longer live in Liverpool. I got out of that hole 2 years ago. Bye for now, au revoir, and to all our friends out in the Middle East, may your camel never dump at he feet of the Ayatollah.

If his group of companies has a site

licence to copy the software between them, then I apologise. I thought I'd better add that in case he's within his legal rights, though his attitude and tone of writing absolutely sucks.

*Callan Hooley, Westbourne.*

Salus Populi Suprema Lex Est and all that.

**■ HELP! Will it run?**

I bought a secondhand Victor Technologies Sirius 1 computer which works fine, but I would like to run PC compatible software on it.

- 1) Is it PC compatible (I seem to remember an ad which said it will run MS-DOS)?
- 2) If it won't directly can I change anything to make it run such software?
- 3) Failing that, could you tell me of anywhere I might get hold of some manuals for it as the only one I have is for Victor-writer.
- 4) Lastly, could you tell me which part is which at the back so I can connect my Star LC10 printer.

The Sirius only cost me a tenner so to make it PC compatible I would be willing to spend on a conversion if necessary.

*Rob Wood, Liverpool.*

To take them in numerical order:

- 1) No. MS/DOS compatibility doesn't guarantee PC compatibility.
- 2) No, by tweaking, you might get some well behaved software to run but not all.
- 3) Let's wait and see if any kind Tech Tipper can help with manuals. Send them in to this address and I'll pass them on.
- 4) As I don't have a schematic for that computer, we'll have to wait and see what turns up in the mail.

**■ HELP! The plot thickens**

I have a Sharp MZ-1P16 Plotter, but I'm at my wits end trying to interface it to my Amstrad PC1512.

I can't make head nor tail of the diagrams sent by the dealer. All I have managed to do so far is to replace the 'screened' cable with some twenty-six way ribbon. But to connect it to my PC is another matter.

I have enclosed a photostat of the diagrams I was sent by the dealer from whom

I purchased the Plotter.

I hope you can decipher these helro-glyphics and give me a clue as to how I can this plotter to my PC.

*Tom O'Connor, Port Glasgow, Inverclyde.*

From the look of the diagram, I think that the dealer's been eating funny mushrooms. I'll be looking into the problems of interfacing unusual printing and plotting devices in Circuit City in the near future and I promise that the MZ-1P16 will be first on the list with some simple to understand illustrations

**■ HELP! ST/CPC time warp**

I am planning to upgrade my CPC 6128 to an STFM. However, I am reluctant to purchase a TV or expensive colour monitor.

I would like to know whether I could use the CPC's colour monitor (CTM 644) with the ST. If so, as I am not a dab hand at soldering, where could I buy a ready-made lead? Which screen modes can be used and what is the quality like?

*Stuart Carter, Swindon.*

We covered the very same project a couple of weeks ago answering your questions, but to remind you of places to buy ready made leads cast your eyes back a little along this column to the letter headed HELP! Leads please.

**■ HELP! Blind Lynx**

Imagine the joy at finally owning a Lynx. Imagine the enjoyment the little beast gave me. Imagine the disappointment of finding the LCD had been cracked. Imagine the horror of being informed first by Evesham Micros and then Atari that a repair was impossible. So my only option seems to be to splash out on another fully working Lynx, even though to all extents and purposes I have one already, not that I'm happy to do so. I'm loathed to believe that someone somewhere can't do a thing about what is, apart from the fact that I can see damn little of what is going on, a fully working machine.

*J E Morris, Pershore.*

We talked to a couple of LCD specialists and they confirmed what you've already been told.

There doesn't seem to be anyone around doing replacement LCD screens for the small hand helds. No doubt in a couple of years when they're a bit more common, there'll be a thriving industry in spare parts ... or maybe the price will have dropped low enough to make them consumable.

**■ TIP! Maplin's rescue**

Jack Blackler's problem is, I believe, solvable by Messrs Maplin. They do a chip numbered MAX232 which has a built-in voltage converter, 5v in, 10v out and vice versa. A few more small components are necessary. Maplin's part number is FD92A. Ask for the application sheet which will give all the details when ordering.

Actually, if you look on page of currant *Express* you will see the relevant page of the Maplin catalogue. Did I hear something about the left hand and the right?

*E A R Coustick, Birmingham*

Cheeky monkey! Ta for the help though, You win the "At least someone scans all the small print" award for this month. All you have to do now is scan the small print for the details of your prize.

**■ TIP!/HELP! Star printer**

I have often read that the AMSTRAD 9512 does not recognise or drive any other printer unless the daisy wheel printer is connected. This, as you know, is not correct when using Locoscript. All my writing is done on a DMP and the daisy is never plugged in until I want to use CPM. But this gives rise to another thought. If Locoscript can print on a DMP without the daisy connected why can't some genius amongst your readers come up with a file that can be added to the CPM disk to enable the daisy printer to be discarded altogether?

I use the STAR 24-10 printer and as I said the daisy is never used for printing. It just takes up space on my desk that could be put to better use.

*R Terrett, Bristol.*

Why not indeed? We await the file with fingers crossed and 3 inch disk hot in the drive.

**■ HELP! PD library**

Recently I have come into possession of an old Commodore PET with double 4040 disk drive and a printer. However, there is an extreme lack of software for this machine and I would be grateful if you could reprint the address of ICPUG who you said had an excellent PD library.

Also on the Commodore, I would be grateful if you could print some details of the manuals which you said could be obtained at local libraries. I have tried for some time to get hold of them, but my library says it needs more information to track them down.

*John Gillilan, Stirling.*

Flick to page 56 for our lists of user groups and on line pages. You'll find that the chubby chaps at ICPUG get a regular mention.

• Pet keyboard and monitor - first released in 1977

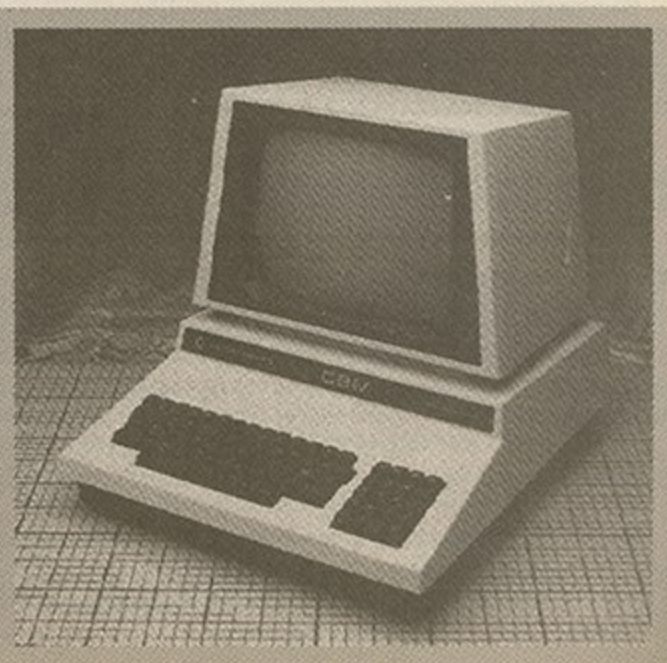

**Nightbreed Slideshow • Amiga  
• Lorenzo's Domain • Disk 308**

Have you seen *Nightbreed* yet? It's the film of the book *Cabal*, from the famous spook specialist Clive Barker. It's a horror cum action movie which features astounding special effects and amazing make up. Against this though, it isn't really very good.

You could go and see the film, but to get to see the excellently made-up monsters, you'd have to sit through an hour and a half of tedious non-stop gore.

Well, you don't have to you know. Spookily enough, the *Nightbreed Slideshow* is a collection of digitised stills from that very same film.

There are lots and lots of pictures, and all your favourites are depicted in the showing. They really are of superb quality, and must be among the best digitised pictures in any Amiga owner's collection.

**The Education of Cool Cougar  
• Amiga (1Mb required)  
• Lorenzo's Domain • Disk 412**

The Education of Cool Cougar is an Amiga-ized cartoon in the classic mould of *Road Runner*. The cartoon action takes place in front of a digitised background of desert. The characters are

# THE PD COLUMN

There's a wealth of free software out there which is yours for the price of a disk. Our PD man, Adam Waring, takes a look at what manner of sumptuous freebies are on offer this week...

hand drawn in cartoon style. The Cougar wishes to eat the little bunny wabbit, but ultimately comes to a sticky end. The animation is brill, the sampled sound effects are jolly good too. It lasts under a minute, but is excellent fun and well worth showing off to your friend.

**Disk utilities • PC • Oligram  
• Disk X017**

PCs are reliable beasts. That's one of the reasons why practically every business in the UK (and all over the world for that matter) uses them. Like any complex piece of machinery, things can go wrong. It's just as well to know that your machine isn't just about to cough and splutter to a halt.

Well now you can know. No more sleepless nights, breaking out into cold sweats. You needn't worry whether your

machine's in tip-top condition or not. There's a whole bunch of utilities on this disk that will let you know just how well your machine is feeling, and how favourably it compares with others. (I knew I shouldn't have bought that cheap Taiwanese clone from Honest Joe's computers and second hand car sales...)

*Coretest* informs you of the state of your hard disk. It performs a test that measures the efficiency in terms of speed, size and general sexiness.

The program rapidly reads and writes data to the disk, and gives you all the stats. Seek-time, speed of data transfer and various other techie terms are taken into consideration. The combined results are given as a performance index.

The program has been written by a company which specialises in - would

you believe - very fast hard drives. In its final analysis it compares the efficiency rating of yours with theirs, telling you just how rubbish yours is in comparison.

Disks that are used frequently - whether they are fixed or floppy - lose performance compared to fresh ones. This is because every time you load and save information the data is redistributed all over the place. If you erase a batch of files, gaps will be left over the surface of the disk. When new information is written, these gaps will be filled up, leaving files spread in numerous places.

This slows things down considerably. The disk-head zooms around all over the place, constantly moving back and forth as it searches for the elusive data. The net result is loss of speed. Information stored sequentially on the disk is accessed much faster.

## AMIGANUTS UNITED

169, DALE VALLEY ROAD, HOLLYBROOK,  
SOUTHAMPTON, SO1 6QX  
PHONE 0703 785680 - 10am to 7pm Weekdays  
& 1pm to 5pm weekends

- |  |       |
|--|-------|
| 521: ALL NEW STAR TREK, with AUTHORISED English instructions. (2 DISKS).   | £4.00 |
| 812: STAR TREK (US VERSION) 1 meg 2 drives (2 DISKS).  | £4.00 |
| 634: The funny DONALD DUCK animation plus the WINDMILL anim.   | £1.50 |
| 639: C MANUAL by Anders Bjerin. A three disk set, containing 200 pages of instructions on opening windows/screens/graphics/gadgets/sprites etc. Loads of examples/source progs. (FULL KNOWLEDGE OF THE CLI IS REQUIRED).   | £6.00 |
| 649: BUDBRAIN. An excellent TWO DISK MEGADEMO, (FOR ADULTS ONLY).  | £3.00 |
| 640: 8 GAMES THE TRAIN SET makes this one a MUST for the kids.   | £2.00 |
| 680: WORD SQUARE SOLVER - Solve magazine puzzle squares with this one.   | £2.00 |
| 681: AMI-FX ISSUE 1. A 3 DISK SET FOR FRACTAL ENTHUSIASTS. (1 MEG MIN).  | £5.00 |
| 700: TETRACOPI. A good copier program by the same team that did XCOPI.   | £2.50 |
| 705: AMIBASE PROFESSIONAL. A licenceware database prog. by KEITH GRANT.  | £2.50 |
| 717: MUSIC DISK 53 tracks lasting OVER 90 MINS! (For the collection).  | £2.00 |
| 728: UTILS with BOOT-SHOP, IFFMASTER, BOOTKIT, DISKSCAN and others.  | £2.50 |
| 740: MED V2.13. A COMMERCIAL quality version of this FANTASTIC music utility with a host of new additions, including synth sounds etc.   | £2.50 |
| 741: NorthC V1.2. The VERY LATEST from Steve Hawtin, this new set comes on TWO DISKS and is packed with extra progs/examples/advice on bugs.   | £5.00 |
| 755: SUPER C COMMANDS disk from TWILIGHT (fast REPLACEMENT C DIR progs).   | £1.50 |
| 760: Letter writing disk by GRIZZLY, set up and ready for your letters.  | £1.50 |
| 785: MOBED. A good object editor by Martin Jones, (experience required).   | £1.50 |
| 790: PROFESSIONAL SOUNDTRACKER V1.0 is here! Just press HELP key, whilst running, for full instructions, ALSO latest Ntracker V2.12, by Exolon AND the FINAL version of DISKMASTER (V3), a very good CLI REPLACEMENT TOOL. | £2.50 |
| 798: ROB BAXTER'S AMIGADEUS (Mozart). Long running classical music disk.   | £1.50 |
| 805: The Fantastic WRATH OF THE DEMON. Long running Animation demo.  | £1.00 |

**AT LAST! THE DISK THAT ALL CODERS HAVE BEEN WAITING FOR.**

**ACC 1-4:** The first four compressed issues of a new disk for coders, even if you are new to computers, this is the one to buy if you want to learn assembly etc. Absolutely PACKED with advice and sources etc., (devpac). Edited by MARK MEANY. THIS INTRODUCTORY ISSUE IS ON SPECIAL OFFER TO READERS FOR ONLY £1.50.

**ACC 5:** Here is the next issue of what looks like becoming a hot favourite with new and old Amiganuts alike. Packed with source, hints & tips from many of the well known people on the Amiga scene today. (This is a licenceware disk) £2.50

Competition issue catalogue disk is now available, you could win £100 worth of progs. (3 prizes). Send £1.00 and ask for your copy now!

All prices quoted above include the disk and return post/packing

We are the official UK distributors of the fantastic T.B.A.G. disks from USA and the very latest from this collection is always available from us first.

Prices start at only 50p (with disk) + FREE membership with first order

## Lorenzo's Domain Amiga P.D. & Shareware

### A SMALL SELECTION FROM A GREAT COLLECTION

- |   |   |
|---|---|
| <b>MUSIC</b>  | 407: Walker 1 Animation (1 meg). Been around for a while. A classic       |
| 101: Definitive Docklands by H.C.C.<br>Fantastic colour pictures and music    | 408: Walker 2 Animation (1 Meg). Yep! You got it another Classic          |
| 102: Lorenzo's music utility disk. Rippers and Players galore.                | 412: The Education of Cool Cougar (1 meg): Brilliant                      |
| 104: Lorenzo's musical delight  | 413: The Probe Sequence   |
| 105: Future Composer  | 414: Space Ace Demo: (1 meg) Animation Sequence from game                 |
| 106: Noise Tracker Collection (3 Disks)                                       | 415: Fillet the Fish Animation by Jester Bros International               |
| 111: Rave Demo (1 Meg) by H.C.C.  | 416: Stealthy II Animation: (1 Meg): Beautifully drawn and quite funny.   |
| 114: New music demo by H.C.C. 5 great new tunes with a cool menu screen       | 417: Lotus & Unicorn animation: (1 meg): You'll like this one.            |
| 115: Miami Vice Mix: Fantastic digitised song with neat picture.              | 418: Knight Animation: (1 Meg): A picture in a book comes to life.        |
| 116: Northstar & Silents Acid demo.   | <b>GENERAL</b>  |
| 119: Derek & Clive Live: (2 disks): X-Rated: Hilarious digitised comedy.      | 500: Jazzbench: Jazz up your workbench                                    |
| <b>DEMOS, INTROS &amp; MEGADEMOS</b>  | 501: Fonts Disk: Loads of fonts   |
| 210: Alcatraz: Megademo 4: (3 disks)  | 502: Wordprocessor  |
| 216: Another Lorenzo Compilation pack   | 503: Spreadsheet  |
| 217: Yet another Lorenzo Special collection including Coma, Spring on a Thing | 504: Database   |
| 220: Collection of intros including Trip to Mars and Meg Zarjaz               | 505: Ghostwriter and Rainbowriter: Intro Writers                          |
| 221: Popeye Meets the Beachboys: It's ravin mad pal.                          | 506: Dope Intro Writer  |
| 222: BudBrain Mega Demo X (2 disks)   | 507: Virus Killer disk  |
| 223: Deathstar Mega Demo (2 disks)  | 508: Tetra copier. New and very very good.                                |
| 226: Freddy Krugar Rap.   | 509: Mobed. Excellent moveable object editor. Sprites come alive easily   |
| 228: Robocop demo.  | 510: ESA utility disk. Tons of very useful utilities                      |
| 229: RAF Megademo: (2 disks): Some great animation on this one                | <b>GAMES</b>  |
| 230: Red Sector Megademo: (2 disks): Simply one of the best around.           | 700: Lorenzo Games Collection 1: Old faithfuls Invaders etc               |
| <b>GRAPHICS PICCY'S AND ANIMATION</b>   | 701: Fish 347: Drip Game: Pure dead brilliant                             |
| 304: Fish 295: Mandel Mountains   | 702: Star Trek 3: (2 disks): absolutely fantastic                         |
| 305: Lorenzo Graphic Utilities  | 703: Return to Earth  |
| 306: Newtek Demo Reel 3 (1 Meg) (2 Disks)                                     | 704: Blizzard Game  |
| 308: Nightbreed Slideshow by H.C.C.: These are the best pics I've seen yet.   | 705: Monopoly   |
| 312: Joe Slideshow 2: Great pictures by Joe of Scoopex                        | 706: Star Trek (1 meg) (2 disks)  |
| 313: Space Bubbles Slideshow: Definatly above average slideshow.              | 707: Paranoid: Arkanoid like game with its own screen editor.             |
| 400: Puggs in Space by Dionysus: Great anims and Brill music... Yeehaa        | 708: Computer Conflict: (Enhanced with 1 Meg): A rather nice shoot em up. |

ALL DISKS  
99p  
each

### ONE DISK FREE WITH EVERY 10 ORDERED PLUS EXTRA SURPRISES

No membership. FREE catalogue with every order. When you choose from Lorenzo's Domain you can be sure of getting the best VIRUS FREE P.D. around. We aim to have your order back in the post within 2 hours. Send your order with a cheque or P.O. and 50p towards p&p to:

**LORENZO'S DOMAIN  
30 COLQUHOUN SQUARE, HELENSBURGH, G84 8AQ**

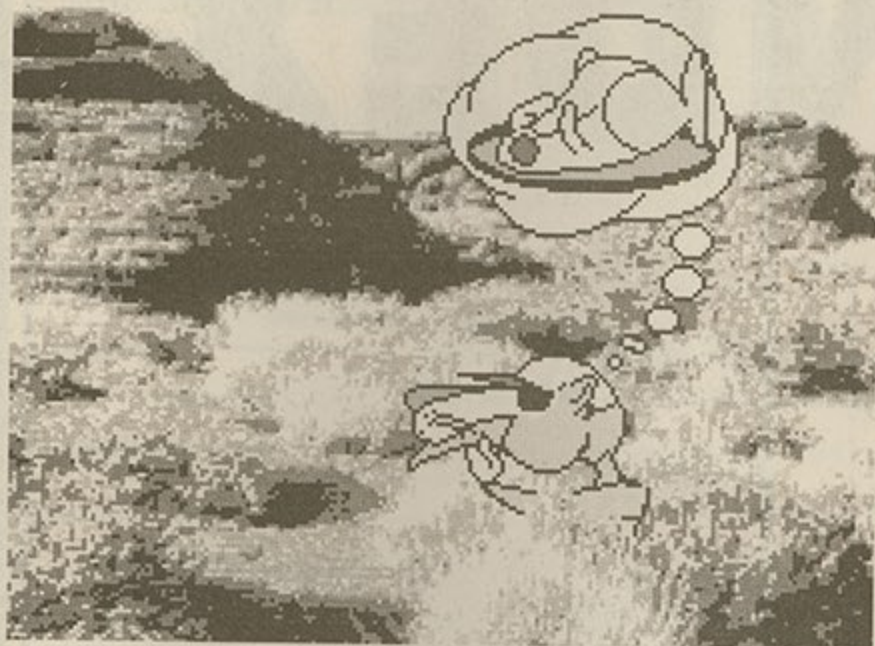

• Classic cartoon capers with Cool Cougar and his furry friends.

For most applications, this difference in speed is inconsequential. What's a few milliseconds? However, programs that make constant disk access will become noticeably slower. A database is a typical example, it's frequently accessed and constantly updated and changed. The files for this kind of program get very disorganised with time.

The program *Reformat* is intended to tidy up your disks. It works by reading

all the information and then re-writing it in a more logical order. It'll do the business with both hard and floppy disks though it's recommended that you remember to back-up everything before you commence the operation. If anything should go wrong midway through - well, you'd really be in the poo if you hadn't done this.

Hard disks are a big job, taking anything up to half an hour or more to redistribute the data. The process is

fully automatic, so you can leave your computer to it while you go and have a cup of tea and some buns.

Just how fast is your disk drive? It may seem like a silly question, but to maintain accuracy, it is important that the disk drive keeps up a constant rotation speed.

300 revolutions per minute is the norm, so if your drive's playing up, then maybe it would be a good idea to check that it's keeping perfect time.

That's exactly what *RPM* sets out to do. Bung a disk in the drive. *RPM* sets it spinning, and tells you whether your computer is driving above - or below - the speed limit.

*Diskoray* is another speed test program. It allows you to measure the speed of any disk drive in milliseconds, and step in or out by a track at a time.

It's not all disk related stuff on this disk though. *Pknpak* is a program de-archiver. It's especially welcome, as many of the utilities on the disk come in archived form.

*87 Test* tells owners of the 8087 co-processor chip it's doing its sums correctly. I can't really imagine the answer would ever be anything but 'yes'.

There are a couple of pretties on the disk too. There's *EGAFrac*, for minutes of fractal fun. A little program called *LJ* - don't ask me what it stands for - has also been lovingly carved onto the ferric oxide coating of the disk. Weird

### WHERE TO GO

● **Oligram**, 68 Queen Elizabeth Drive, Normanton, West Yorkshire AS6 1JS. Telephone 0924 892106. Oligram concerns itself with software for both PC and Atari computers alike. All the disks in the PC library are based on 360K 5.25 inch formats, but can be supplied 'doubled up' on 720K 3.5 inch disks - at no extra charge! All the disks are priced at £2, regardless of whether they're 5.25 or 3.5 inches.

● **Lorenzo's Domain**, 30 Colquhoun Square, Helensburgh, Scotland G84 8AQ. This Amiga library has a very 'clubby' feel. Competitions are run regularly, and they aim to send out your disks within a couple of hours of receiving your order. The disks are dirt cheap too. The princely sum of 99 pence is all it costs for a disk full of delightful PD.

shapes and patterns come dancing spectacularly all over the screen. What's more there's lots of variables to twiddle, effecting the way the patterns are formed and move. It's about as much use as a Zippo in a Zeppelin, but that didn't stop me from sitting happily for hours in front of my monitor just marveling at it. Well, I suppose simple things please simple minds. ■

## SOUTHERN P.D.

Amiga P.D. library open 7 days 9am-7pm Tel 0273 517147

- |                                       |                          |
|---------------------------------------|--------------------------|
| A005 Puggs in Space                   | A048 Avenger Megademo    |
| A009 Predators Megademo. (2 disks)    | A046 BAD (M Jackson)     |
| A013 Kefrens Megademo 8. (2 disks)    | A042 Amiga Chart 3       |
| A012 Alcatraz Megademo 4 (3 disks)    | A061 THR Demo            |
| A015 Star Trek Game 1 (2 disks 1 Meg) | A053 Crusader Bacteria   |
| A019 Powerlords Powermix 1 (1 Meg)    | A054 Amiga Music 1       |
| A023 Vangelis Demo (1 Meg)            | A058 Crusader Audio X    |
| A024 Digital Concert 2                | A059 Vision Megademo IV  |
| A038 Digital Concert 3                | A082 Rebels Megademo     |
| A039 Digital Concert 4                | A083 Space Ace Demo      |
| A078 Budbrain Megademo (2 disks)      | A081 Amazing Music 1     |
| A080 RSI Megademo (2 disks)           | A112 Madonna: Spanky     |
| A117 Shadow of the Beast Demo         | A116 Uedit (W/Processor) |
| A119 Turtlemania by Red Devil         | A109 Kefrens Jukebox     |
| A101 Game Music Creator               | A100 Yahzee (dice game)  |
| A093 Ace Demo Disk 2                  | A071 Mig Demo disk 55    |
| A089 Ian & Micks Megademo             | A036 D-Mob Music 4       |
| A090 Link First Megademo              | A073 Darkstar Utility 3  |
| A070 RAF Megademo (2 disks)           | A110 Amiga Chart 5       |
| A017 Eatmine (boulderdash Game)       | A027 No Limits Demopack  |
| A044 Space Blitz (4 space games)      | A004 Nasa Pictures       |

Blank disks 70 pence each or 10 for £6.50

All P.D. disks are 99p each + 60 pence P+P (please note some demos are 2 or more disks)

Please make cheques/postal orders payable to Southern Computers  
31 Hanson Road, Newhaven, East Sussex, BN9 9EQ.  
Please send a stamp addressed envelope 9x4 for a free catalogue

## SHAREWARE IN YORKSHIRE

PACK OR SINGLE PROGRAMS :-  
ALL IBM FORMAT 5¼ OR 3½  
PACKS INCLUDE :- AUTOCAD UTILITIES/D BASn / CLIPPER / TURBO PASCAL / TURBO-C QUICK BASIC / TURBO-BASIC / WORDPERFECT-TOOLS / SYMPHONEY TOOLS / VENTURA-PUBLISHING / MS-WINDOWS PROGRAMING TOOLS

100 VERY BEST PROGRAM PACKS  
VOL 1 - 2 - 3 20 DISK VOLUMES

GAMES PACKS  
10 DISK PACKS THE BEST  
EGA VGA

DATA COMMS PACKS 30 DISKS

+ MANY MANY MORE

DETAILS SJG SYSTEMS  
109 MILLFIELD LANE, TANG HALL,  
YORK YO3 - 0JP  
0904 - 430320 / 415246

# IRLANDEX

## BASIC MACHINE PRICES

286/12.....£300

386sx.....£438

20 Mhz 386.....£580

25Mhz 386.....£787

**FREE DELIVERY,  
FREE WORD PROCESSOR  
AND**

**FREE Supercalc.**

**Cost £1150.00**

**IRLANDEX  
150 Appleton Park,  
Finaghy, Belfast, BT11.**

**Tel: 0232 600075**

**Fax: 0232 664357**



# DISKS DISKS DISKS DISKS DISKS

## SPECIAL OFFERS LIMITED PERIOD ONLY

### GENUINE 100% CERTIFIED SONY DISKS

QUANTITY	10	25	50	100
3 1/2" DS/DD 135tpi	45p	44p	43p	41p

3 1/2" Coloured DS/HD 2mb SPECIAL OFFER 80p each  
(minimum quantity 10 disks)

3 1/2" DS/DD 135tpi COLOURED DISKS 45p each  
(minimum quantity 10 disks)

### BANX BOXES

Lockable stackable 3 1/2" storage boxes holds over 70 disks  
£9.50 each. £8.00 each for two or more boxes

### SPECIAL UNREPEATABLE LIMITED OFFER

5 1/4" grey library case holds 10 disks - 60p each

All the above disks come with labels V.A.T included. Please add £2.50 postage & packaging £10.00 next day delivery (UK only). To take advantage of the above special offers call our **HOTLINE** now on **0784 451011** DON'T DELAY, OFFER ONLY AVAILABLE WHILE STOCKS LAST. When ordering by phone please quote NCE/MV or post your order with cheque/PO to:

MediaVALUE,  
NORTHUMBERLAND  
HOUSE, DEPT NCE/MV,  
DRAKE AVE, STAINES,  
MIDDLESEX TW18 2AP.  
TEL NO **0784 466744** FAX NO **0784 450845** E & O.E

WE OFFER A NO QUIBBLE  
REPLACEMENT OR MONEY  
BACK GUARANTEE

VISA

Access

# ALL FORMATS COMPUTER FAIRS

Thousands of bargains for every computer!

SUNDAY 4th NOVEMBER 10am - 5pm

SATURDAY 15th DECEMBER 10am - 5pm

AT: The New Hall of the Royal  
Horticultural Society  
Greycoat & Elverton Street  
Westminster London

TUBES: Victoria Pimlico St James Park  
Admission £3.00

STANDS ONLY £75

Book with: JOHN RIDING 0225 447453  
MIKE HAYES 0457 875229

TICKETS: Avoid queuing advance tickets from:  
Mike Hayes 8 Midgrove Delph  
Oldham OL3 5EJ Tel 0457 875229 £3.00 each  
(Cheque Visa Access)

**MEL GROUHE**  
COMPUTER  
Fun Line  
0898 299399  
3 mins of mind  
blowing  
entertainment

**SAM COUPE** THE HOTTEST  
HOTLINE GAMES  
featuring Alan Miles  
& Bruce Gordon  
0898  
299 380

**TONY TAKUSHI**  
CONSOLE LOVE  
0898  
299 390  
games clips  
news gossip

NEW MESSAGES EVERY WEEK  
Publisher & Editor: PD Box 71, Ramoth Wharfedale, Leeds LS16 7BA

Two new brilliant  
books from the  
publishers of  
New Computer  
Express, Amiga  
Format and ST  
Format

If you're the proud owner of a Commodore Amiga or Atari ST, then the *Get the most out of your Amiga* and *Get the most out of your ST* books are invaluable tools for you.



# THE ONLY WAY TO GET THE MOST OUT OF YOUR AMIGA & ST

In 172 information-packed pages it aims to provide advice on all aspects of the Amiga and ST scene: what software to buy, how you can get it free through the PD libraries, how to solve those tricky technical problems, where you're going wrong with a game you can't beat.

You can get all this for the bargain price of only £9.95. Alternatively, for a mere £4 more you can also have two 880K disks absolutely packed with the most useful utilities and the most entertaining programs, carefully picked to be the essential collection from the PD and elsewhere. Start getting the most out of your Amiga and ST!

### BOOK ORDER FORM

- Yes, I would like to order \_\_\_\_\_ copy/copies of  
GET THE MOST OUT OF YOUR AMIGA at the recommended price £9.95  
(Please add £1.45 per copy to cover p&p.)
- Yes, I would like to order \_\_\_\_\_ copy/copies of GET THE MOST OUT OF  
YOUR AMIGA plus two disks at the recommended price of £13.95.  
(Please add £1.45 per copy to cover p&p.)
- Yes, I would like to order \_\_\_\_\_ copy/copies of  
GET THE MOST OUT OF YOUR ST at the recommended price of £9.95  
(Please add £1.45 per copy to cover p&p.)
- Yes, I would like to order \_\_\_\_\_ copy/copies of GET THE MOST OUT OF YOUR  
ST plus two disks at the recommended price of £13.95.  
(Please add £1.45 per copy to cover p&p.)

If paying by cheque, please enclose payment with this card in a sealed envelope addressed to:  
Get the Most...Book Offer, FREEPOST, Future Publishing Ltd, The Old Barn, Somerton,  
Somerset TA11 7BR. (No stamp is needed if the letter is posted in the UK.) Please allow  
up to 28 days for delivery.

Name: (BLOCK CAPITALS PLEASE) .....

Address: .....

Postcode: .....

Telephone: .....

I enclose a cheque for £ .....

Made payable to Future Publishing Ltd

My credit card number is: .....

Expiry date: .....

Signed: .....

I wish to pay by Access/Visa\*  
(\*please delete as appropriate)

# JUDGE DREDD

I AM THE LAW

In your local  
computer  
store today

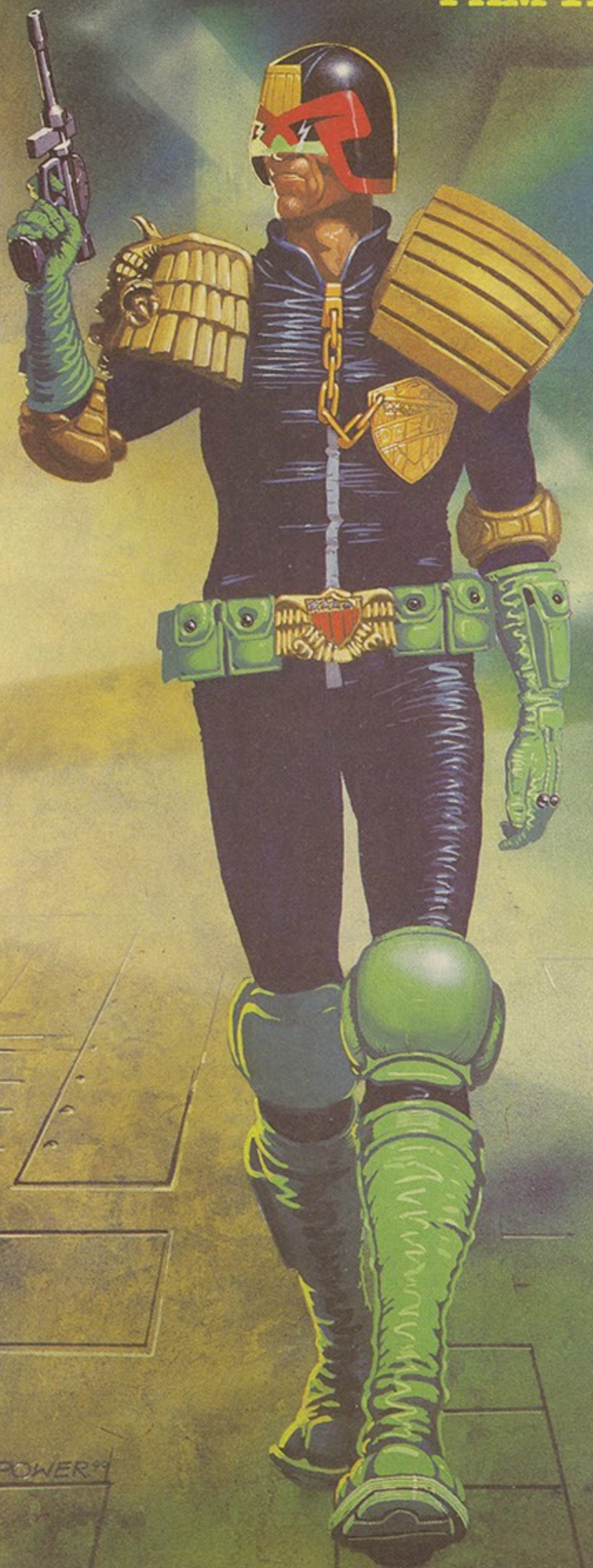

AMIGA • £19.99

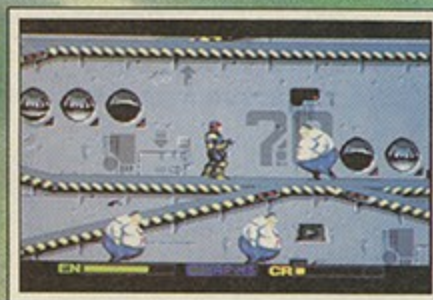

ATARI ST • £19.99



AMSTRAD • DISK £14.99  
AMSTRAD • CASS £9.99



SPECTRUM +3 • DISK £14.99  
SPECTRUM • CASS £9.99

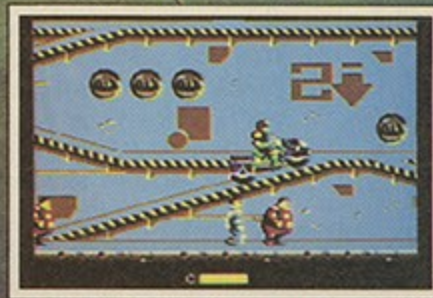

CBM 64 • DISK £14.99  
CBM 64 • CASS £9.99



**OUTLANDS BECOMES OUTLAWS**

The last couple of weeks I've been waffling on about *Outlands*, the North American Indians game. The latest news is that there's now not a North American Indian in sight. The scenario has been completely re-vamped so that it's set in Sherwood Forest. Instead of playing an Indian spirit you assume the role of Herne the Hunter and you have to work to pull the merry band of men together. An excellent text parser enables you to pass instructions to characters, eventually leading you to take on the Sheriff of Nottingham. With a glut of Robin Hood films planned for release next year, Sherwood Forest games may well end up in vogue.

**SPIDEY INTO A NEW DIMENSION**

Just time for a quick mention about *Spiderman*. Saw a pre-production copy of the game on the ST, Amiga and C64 last week and the signs are that it may turn out to be a surprisingly absorbing game. Unlike other *Spiderman* games it's not an all-action romp but a strat-

Mark Higham's  
**GAMES WEEK**



egy with some taxing problems. The game is centred around switches which must be opened or closed to open up a route through to more of the game. The game sprites are tiny, particularly on the ST and Amiga where massive sprites have become an essential ingredient of any game. It's unlikely to do amazingly well at this time of year because it's not the usual see-'em and blast-'em stuff but if you're looking for something with a bit more meat, give it a shot. ■

**PLAYING TIPS**

**ULTIMA V ORIGIN • Mindscape**

Tips for this addictive adventure, the fifth in the *Ultima* series, come from D Perrin

- Use moonstones to escape from underworld
- To avoid the tricky exits from the dungeons on level 8 follow these five steps:

1. Get yourself a moonstone
2. Go to level 8 of the dungeon
3. Cast a "Down Spell"
4. Once you have found an object, drop the moonstone and enter it when the gate appears
5. If you get the timing wrong you may need to try this routine again.

Some people have been having problems trying to get hold of *Ultima V*. If you are still searching for your copy, why not give Mindscape a call on 0444 86545.

**THE ALL FORMATS TOP 10**

For the week ending 6th October

1	<i>Guardian Angel</i>	Code Masters	SP/CO/AM/ST/Ag
2	<i>Run The Gauntlet</i>	Hit Squad	SP/CO/AM/ST/Ag
3	<i>Soccer Double</i>	E&J Software	SP/CO/AM
4	<i>Quattro Combat</i>	Code Masters	SP/CO/AM
5	<i>Quattro Adventure</i>	Code Masters	SP/CO/AM
6	<i>Shadow Warriors</i>	Ocean	SP/CO/AM/ST/Ag/OT
7	<i>Pro Boxing</i>	Code Masters	SP/CO/AM
8	<i>Rastan</i>	Hit Squad	SP/CO/AM
9	<i>Quattro Super Hits</i>	Code Masters	SP/CO/AM
10	<i>Paper Boy</i>	Encore	SP/CO/AM/ST/Ag/OT

Chart compiled by GALLUP. © European Leisure Software Publishers Association



• Oh look it's Spiderman.

**JAMES POND**

MILLENNIUM • ST & Amiga • £24.99

Ponder, if you will, an ocean bed made poisonous by leaking canisters of chemicals, or water polluted by the waste from a nuclear power plant, or even lobsters trapped in baskets in an already over-fished sea. To solve these marine disasters, Millennium has conjured up its own super-sleuth – the soon-to-be-infamous *James Pond*, in a 007 spoof.

*James Pond* doesn't come armed with any special skills or abilities – he's just a perfectly ordinary fearless sprat. To put the water to rights you have to use this character to solve a series of twelve underwater missions.

Your first big mission is to release lobsters by tracking down keys and dropping them onto the lobsters' baskets. Since you can only carry one item at a time you cannot race round the level collecting all the keys and dropping them over the lobsters later. While

you're mindlessly scattering keys everywhere you need to watch out for Jaws – a lethal fish with a huge bite.

Overcome one mission and up comes another – harder and more complex than the last. With each mission you're given a time limit, if you run over time a police frog-fish, armed with snorkel and diving suit, comes and gives you your marching orders. The later missions demand that you decimate oil platforms by placing sticks of dynamite round the platform legs (not very ecologically friendly) or direct fish out of the harmful way of toxic water.

As the game progresses you can pick up glasses to view invisible jellyfish, a ray gun or a even a simple

**GAME REVIEW**



goldfish bowl, which doubles as a breathing helmet during those awkward moments when you're out of the water.

With very bright, lively and colourful visuals, the game has a comic setting. Sadly, left and right scrolling in the ST version is particularly jerky. Complementing the graphics, is some excellent music. If you choose to turn off the music you can play with sampled sound effects instead.

Combine superb graphics and sound with some very absorbing missions and you get yourself an excellent new concept – all the better because at this time of year the charts are flooded with unoriginal but big name arcade and movie licences.

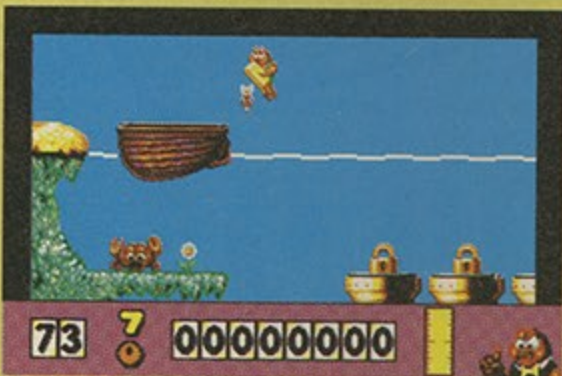

• In this first level you must rescue lobsters by picking up keys and dropping them onto the baskets. Watch out for the bonus room where you can pick up heaps of points.

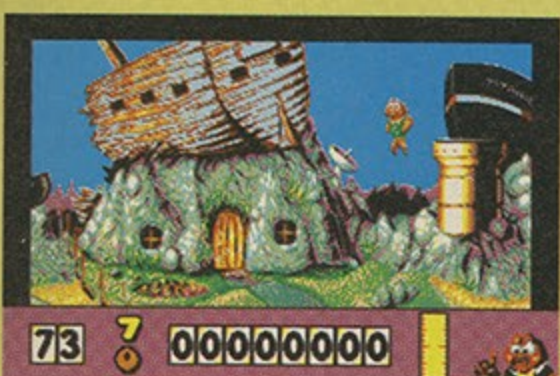

• James "super sprat" Pond hits the water and makes a big splash. Solve twelve underwater missions to make the sea a safer place to swim in this comic 007 spoof.



• Another of the twelve highly-dangerous missions for James Pond. Not only is the costume embarrassing for such a suave secret, but just think what the cold does for his Beretta!

# SAMSUNG 286-12Mhz (SPC6512) ONLY 750.00

## PRICE INCLUDES

40 Meg Hard Disk  
Unisys Mono VGA Monitor  
VGA Card (for above)  
102 Key Keyboard  
1 Serial / 1 Parallel Port  
1 Meg RAM on board  
Dos 3.3 & GW - Basic

## ADD-ON OPTIONS (please Add)

VGA Colour Monitor	200
Super VGA Colour Monitor	250
1.44 Meg 3.5" Floppy Drive	50
A4 Handy Scanner	125
A4 Mouse	30
Microsoft Windows 286	45

(All Prices Exclude VAT & Delivery)

# DOUBLE COMPUTING

269 Bury New Rd.

Whitefield

Manchester

M25 6QQ Tel. 061-766 3417

We also supply a full range of computer Accessories and Peripherals

## MAJOR STOCK CLEARANCE

### IBM PC/XT COMPATIBLE FOR UNDER £300

- \* 8088 Processor running at 8MHz
- \* 1/2 Mb On-Board RAM (Expandable)
- \* 1X360k 5.25" FDD (Room for second disk drive)
- \* Maths Co-Processor socket
- \* Mono/Colour Graphics Card
- \* 2 Conventional Expansion slots
- \* Room for 3.5" Hard Disk(Standard SEAGATE etc.)
- \* Fully Expandable at any time
- \* MS-DOS 3.3 & GW-BASIC 3.2
- \* 102 key keyboard made by EPSON
- \* 12" Mono Monitor (New/Ex-Display)
- \* Full UK Specification
- \* Battery Back-Up.

IDEAL FOR  
CHRISTMAS

Save another £25!  
See us at the All Formats  
Fair on Sunday Nov 4th  
ONE DAY ONLY -  
£275!



# £299.95p

inc. VAT & Carriage

Made by a Famous Korean manufacturer to the highest specification. Ideal for Students, Business, Hobbyists, Home Word-processing, Amateur Radio, etc.. At our price of £299.95p fully inclusive, this is better value than buying a PC Emulator for your existing computer. The Perfect Present for Christmas. ORDER TODAY by simply picking up the telephone.

Access

VISA/ACCESS orders welcome. Prices subject to change without notice. All transactions are subject to our standard conditions of Sale available upon request. Personal callers welcome by appointment. All prices include VAT.

VISA

**UK HOME COMPUTERS**  
82 Churchward Ave., Swindon, Wilts. SN2 1NH.  
Tel: (0793) 695034 FAX: (0793) 541691

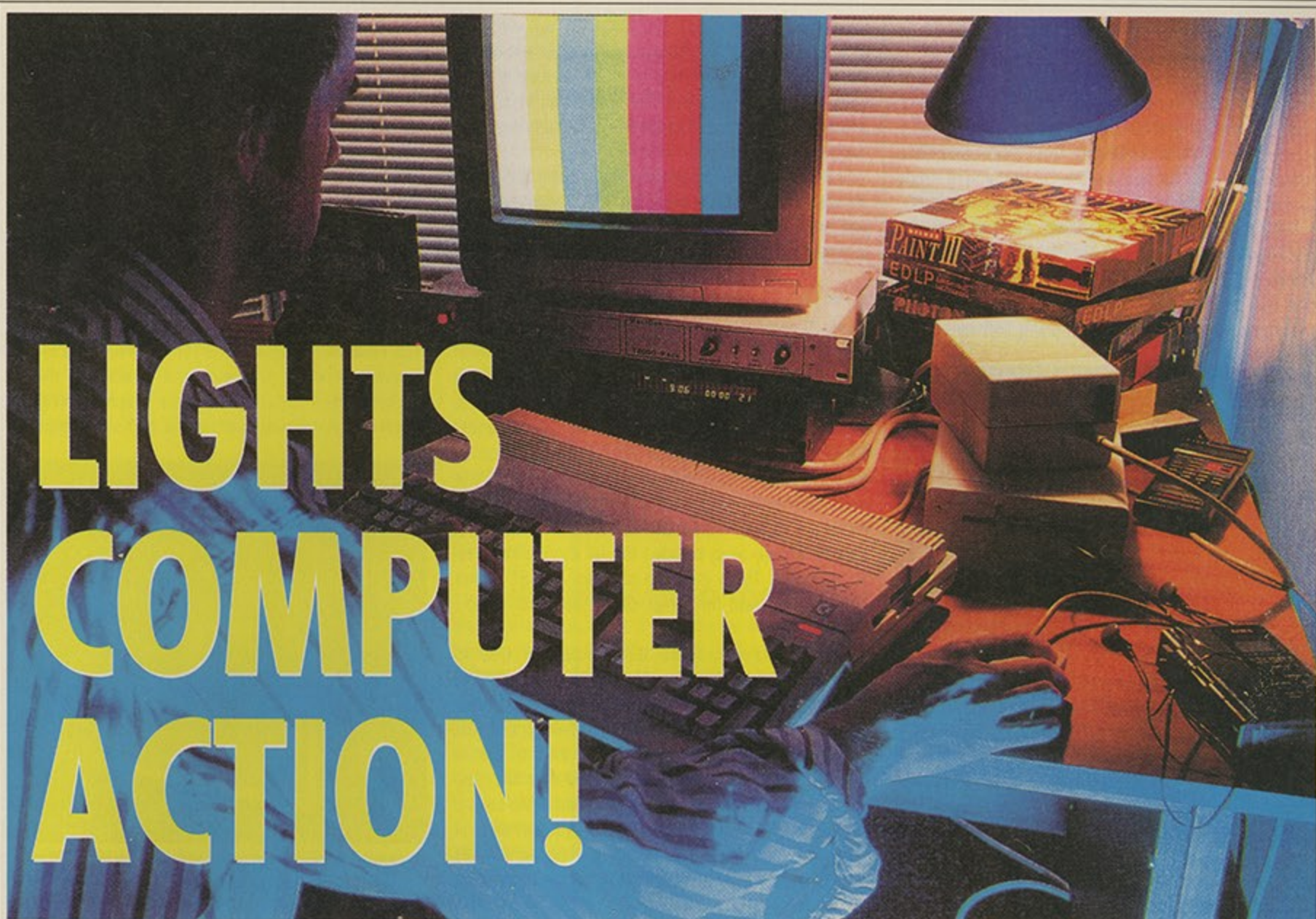

# LIGHTS COMPUTER ACTION!

**M**ore than any other invention since perhaps the wheel or the internal combustion engine, the computer has created work for people. Not in the sense that they make existing jobs difficult, although in certain cases this is true, but in the sense that they create job titles that didn't previously exist. For example, people with a keen design sense who are too messy or unco-ordinated to be paste-up artists have found gainful employment in magazines produced by desktop publishing.

This idea of producing something entirely in the memory of a computer is a new and ever expanding field. It became obvious, when DTP became the rule rather than the exception, that desktop based applications would revolutionise the production of the media we all consume. Desktop publishing revolutionised the production of books and magazines by replacing costly paper paste-up and photographic repro processes with Apple Macintosh computers, running programs which make the pages up in memory and output them directly to film.

Desktop music became a reality when the Musical Instrument Digital Interface standard caught on in professional production, and in this field the Atari ST, by having MIDI ports built in, became the accepted standard. Although the ST still holds most of the cards, especially for amateur musicians and cost effective home use, the Macintosh is rapidly becoming the professional choice as the MIDI engine in the recording studios of the world. Having completely changed publishing and music, desktop video is the obvious choice as the "next big thing".

Desktop video, or DTV, is not as well formed a market as DTP or MIDI music but only, because the perfect platform for the medium has not yet emerged from the current pack of hopefuls. As an example, the DTP field only became a force to be reckoned with after the Apple Macintosh became the

**The act of watching and creating television as we know it is about to be changed forever. Phil South calls the shots on Desktop Video Direction.**

perfect DTP engine, complete with all the software and hardware support needed to produce professionally acceptable results, this being the yardstick by which these things are measured. Similarly in desktop music, until the cheap and MIDI literate Atari ST came out, along with piles of cheap and professional software, MIDI hadn't got a computerised leg to stand on. But as yet, no professional quality DTV standard has nosed ahead of the pack, although if any machine can claim to be a contender at this stage in the game, the Commodore Amiga can.

To start with the Amiga was specifically designed in the first place to be fully compatible with TV, positively 'TV friendly' in fact, with common screen resolutions and easy access to TV sync through genlocking. As with the Amiga's sound, the Amiga's graphics have a lot of the hardware needed for external jobs like video sync and A to D converters for sampling already built in. Although the quality of the results you get are fairly low grade as compared with professional titling and solid modelling computers like the Quantel Harry or Iris workstations, the Amiga is in use in more video studios than almost any other micro computer, and more than reasonable results are easy to achieve with minimal equipment.

Also there is more DTV style software and hardware for the Amiga than for any other machine, too. So if you're shopping around for a computer to start with, you are better off looking at an Amiga solution than, say, a 386 PC or Mac.

It's becoming clear that the future of DTV is assured, in one form or another, especially as

another buzzword on everyone's lips at the moment is multimedia. As the Mac, PC and Amiga all have multimedia firmly on the agenda, with things like video E-mail and digital video now being a possibility rather than just a twinkle in the eyes of Apple's Neat Ideas Dept. This Autumn the Amiga based CDTV unit goes on trial in 2,000 British homes and goes on sale in the new year. That, above anything, will show that interactive TV is very much a thing of the present. So, it looks like rather than computers becoming more integrated with video and audio, that video will more likely become just another colour in computing's ever expanding palette.

## AMIGA

No discussion about TV production hardware on the Amiga can begin without first mentioning the G2 Video centre. Although not really a professional product, it is expandable into a true pro video set-up.

There are upwards of eight genlocks currently available for the Amiga ranging in price from just under £100 to well over £1,000, so why is there a need for another priced at £800 odd? Well, the G2 is made by a firm who up until now have specialised in producing pro quality genlocks which don't give you much change from £100,000, so the quality of signal you get from this device is great. Other than that, the machine has sockets for S-VHS, which allows for a much more stable and usable finished image. In fact, as the colour is separately encoded and decoded, the machine can output straight RGB. No conversion to PAL using an RF modulator is needed, as the signal can go directly and cleanly to tape as

RGB video. The quality of the output is as good as you can get on desktop equipment.

Fitting the G2 is simple, you just plug the unit into the RGB out on your Amiga, plug the RGB out to your monitor, and send the composite video down a lead to your video recorder. Then you connect a video source to the input on the G2 and you're ready to mix live or taped video with Amiga graphics.

As well as being high quality, the unit is small, and can easily fit onto your desk along with an Amiga, VCR, TV and Monitor. The functions of the unit can be controlled using hardware switches and sliders on the top of the unit, or using software if you



• The G Videocentre - bringing pro-video to the Amiga

want to hide the unit away.

If £800 is too rich for your blood, then how about the MiniGen, which only costs £99? This is a small phaser shaped unit with plugs into your RGB port and looks not unlike the A520 TV modulator you probably got free with your Amiga. Obviously the scope, and more importantly the quality, of this unit are far below what you can achieve with the G2, but for the tight (or near empty) of pocket this is the cheapest way into the TV business.

Finally, on the hardware front there is the new high end Simpatica system by Artbeat. This is a system where you can transfer Amiga animations and single ILBM files to hi-band video, frame by frame. This allows for smooth animation, but also excellent quality. This is pro quality equipment and comes with a pro price tag of around £1,500, not including the necessary hi-band recorder or Amiga needed to run the thing. The interface box fits between the Amiga and the recorder and drives the machine frame by frame, offloading the animations and frames stored in memory following a list in the computers memory.

In the software stakes the Amiga wins hands down. There are more video products on the market for this computer than any other. Just to mention a few which are essential for serious work: *DeluxePaint III* — This is the premier graphics and animation engine, bar none. Although the program doesn't handle memory hungry 4096 colour HAM images, it outperforms any other package at 2,4,8,16,32 and 64 colour resolutions. *Deluxe Video III* — the video oriented brother of *DPaint*. Allows you to sequence animations using a simple WIMP interface. *The Director* — a more difficult beast, but one which is used professionally to produce computer displays in films and on TV shows like *Star Test*. *AMOS* — not so obvious this one, but this new program enables you to move graphics around in ways not possible with ordinary programs. If you know *Basic*, you know *AMOS*. *Disney's Animation Studio* —

a new program just out from Disney's new software arm. Looks to be the closest thing to real movie animation on a computer ever invented. Disney actually uses Amigas these days in the production of its films and the program was developed using techniques it utilises professionally.

So, the Amiga is already king of the heap, but we will have to wait impatiently to see what will happen once the CDTV interactive video version comes out next year.

## ST

The DTV revolution is far less evolved on the ST than it is on any other computer. There is precious little in the way of hardware and software support for video on the Atari's, mostly due to its technical limitations, problems not unlike those which hold the PC back. For a start it cannot use the full screen area, and so titling is limited to inside the screen border. Other limitations are in the resolution department, and unlike the Amiga, no thought was given to interfacing with TV on any level besides the RF modulator fitted at the back. There is some stuff for the ST owner who is desperate for TV graphics, and that is GST Gold.

Once you've cracked the problem of how to sync the ST to video signals, the rest is easy. But most of this clocking has to be added to the hardware, as the ST has no real method of doing this feat on its own. Certain companies have tried to create external sync pulse generators for the machine, and failed, but one company which has made just such a device is Third Coast Technologies. Although the unit costs a pricey £499 and is the only option for this kind of work, the GST Gold is a remarkably able piece of kit.

Another small problem is that in order to run the GST you will need a Mega ST. This isn't just a RAM problem, although the extra leg room doesn't hurt. No, the 1040 and 520 ST's need to be physically modified to accept external sync and although this

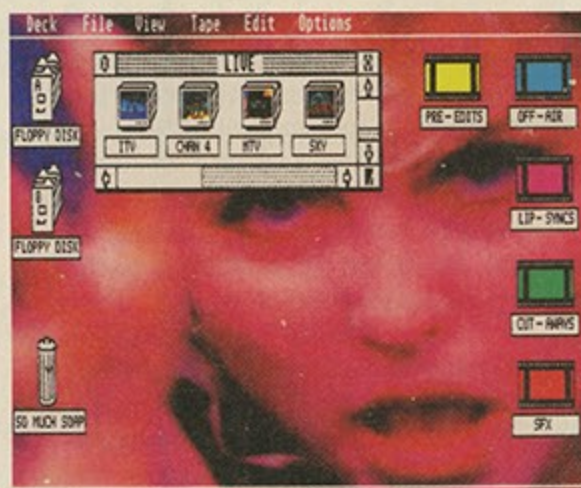

• Change your ST desktop forever with GST's genlock

can be done, it's not to be recommended.

Installation is a tad complex and not for the faint hearted. You have to pop the 2591 chip out of its socket and slip in the new custom housing and plug the chip back in. The lead coming from the housing then feeds the video signals to the ST and GST. So then you're ready to rock and roll, as they say.

After all that minor surgery, it's nice to see something that's just ready to up and run. The new *Deluxe Paint ST* has everything you will need for creating your own video graphics, especially animation. Using the flexible interface designed for the Amiga and PC, the program is by far the best package for fast and flexible graphics creation on the ST. Animation is a breeze, and the program allows you to create and animate in 512K machines as well as Mega ST's and STE's.

Another program which you might not think of as video oriented is *STOS*, from Mandarin software. With this you can create your own animations using sprites and backgrounds. This is easy to use too for animated cartoons and titles.

It remains to be seen if the ST can build its reputation in DTV, as the advanced new STE has yet to show any promise as far as DTV software making use of its facilities is concerned. We'll just have to wait until next year to see how it shapes up.

## PC

Although there are very few low end (and even fewer high end) video applications for the PC, there is one program which is sweeping the board and that is *Animator*. It is an animation and graphics program which lets you create animations and show them on



• Autodesk's Animator: animation and video on the PC at last.

the PC screen. Obviously you need some kind of interface to get the art onto video, but *Animator* is the best way to create the basic graphics you need.

One of the options for video work is the pioneering device from Vine Micros which is a PC EGA flavour genlock. Vine Micros is famous for its CGA/EGA/VGA to RGB monitor or TV devices, and this was clearly seen as an obvious gap in the market, especially noting the success of *Animator* as a kind of standard.

Although the PC figures a lot in the high end of presentation slides and such, the PC is yet to make much of an in road into video itself.

## CHEAP VIDEO

Video is not as expensive a medium to get into these days as it was even just three years ago. The price of high spec equipment has come way down and the introduction of new standards, like Hi-8 and S-VHS, has brought near broadcast quality into the home for the very first time.

Among recent innovations was the Amstrad Twin video, which not only enables you to record two programs at once, but also does tape to tape dubbing. Such a device is invaluable in desktop video and for its small footprint on your desk as well as the technical savings.

Video 8mm is gaining ground as a format, too, with its miniature tapes and high quality stereo sound. This is the portable note book system that, especially using the new high band width Hi-8 system, could form the basis of news-gathering systems based on computer editing suites.

The march of the camcorders is relentless, with more models coming out each week, far too rapid for any of us to keep track of all the new features and prices. Basically the best buy will be the one you can afford. Picture quality has risen to the standard where, as long as it's a name brand and it's fairly stable, like on a tripod, the quality you'll get is equal to

any other machine. Even the new breed of tiny VHS 'C' machines with no internal playback facility offer quality unheard of on older machines costing thousands and weighing about 14 times as much.

Another surprising turn up for the technical books is the rise in production of home editing controllers. Edit controllers operate two video recorders at once, in some cases using the infra red controllers.

## DIGITISERS

No DTV setup is complete without a digitiser and this is very easy to sort out. Some of the best you can get are all made by Rombo - these are the VIDI Amiga, VIDI PC and VIDI ST. Although the Rombo machines are more like frame grabbers (grabbing their pictures from video) very good results can be



• Digitisers are an essential tool in any DTV set-up - they can cost you as little as a £100 or as much as £1000!

gained. Especially using their RGB splitter, which saves off three images for the red green and blue components and then combines them as one picture for full colour grabs. These grabs can be made into animations, allowing you to overlay moving "video images" over other video sources. There are other methods of getting your images onto a computer, scanners and the like, but these will run your budget figures up to the £1,000 mark again. The Rombo units are fast and cost effective.

## EXTERNAL SOURCES

Even if you can't set up a completely independent DTV set-up on your desk, the possibilities for production don't end there. Like the music or publishing industries, it is possible to assemble your productions at home on a computer and post them to a third party who turns your floppy disk and source tapes into a finished production. This has been happening in the magazine business for some while, where writers and artists write or draw the bits of a magazine at home and take them into the office for merging into a finished product. This happens more often in the world of music, where music is written on simple multi-timbral synthesisers in the home and then transferred to the New England Digital Synclavier or similar megabucks production system

in the studio for mixing and recording.

In the home you can set up edit lists on your home computer which are basically textual lists of SMPTE codes and the software tools to tell computer driven video editing suites where to make the cuts in your video automatically. Or with the aid of the *Simpatica* system by Artbeat Computer Graphics, you can actually generate computer generated animations composed of single IFF files and ANIM files which the interface sends to video tape in the studio one frame at a time.

Search the audio visual press for studios which specialise in "off-line editing" and call them to see if they run your make of computer. Agreed - there aren't many at this time - but the numbers are growing. As usual Amiga owners are particularly well served in this regard, with Amiga based studios popping up everywhere like mushrooms, like Alternative Image of Leicester. They provide a service to put IFF format graphics onto 35mm slide and video. Other such services are appearing all the time, so watch the press.

## THE NEWTEK VIDEO TOASTER

Most people say that the technical advance which pushed the Mac into the lead in DTP was the development of the Laserwriter and Pagemaker software. The same people say that the Atari ST was really made by fitting MIDI ports and using Steinberg software. The one thing which could be the equivalent technical advance for the Amiga and DTV is the Video Toaster from NewTek of Topeka Kansas.

Newtek are famous for their digitiser DigiView and many other more advanced programs for the Amiga, but the Toaster is several orders of magnitude bigger than that. Take a seven input switch card, broadcast quality digital video effects, frame



grab and store, character generation, 24 bit frame buffer, 3D animation, and 24 bit paint capability, and stick them all on a card for about \$1,595. The unit began shipping on 3 October this year in the US in an NTSC version, so its full effect won't be seen for a few months yet, and a PAL version still more distant.

If it succeeds in delivering the quality of graphics needed by users of professional systems, it could change TV production, and the role of the Amiga in the marketplace, for ever. ■

## SOURCES

AMOS and STOS  
Mandarin Software (0625) 859333

Disney's Animation Studio  
Titus (0268) 541126

G2 Videocenter  
G2 Systems (0252) 737151

GST Gold  
Third Coast (0257) 424442

VIDI Amiga, PC and ST  
Rombo (0506) 414631

Video and Slide Bureau Service  
Alternative Image (0533) 440041

Simpatica  
Artbeat Computer Graphics  
(0268) 289384

DeluxePaint III, DeluxePaint ST and  
DeluxeVideo III  
Electronic Arts (0753) 49442

## A SHORT DTV GLOSSARY

### ANIM

The Amiga IFF standard file format for animations, usually a compressed series of IFF ILBM files.

### BETAMAX

Or Beta for short. This used to be an alternative format to VHS, but VHS out-sold its machines and so video libraries now very rarely stock it, although blank tapes are still available.

### EDIT LIST

A list of cuts in a film or video tape which using the SMPTE code runs an automated editing machine and assembles a piece of work with little or no human interference.

### FRAME BUFFER

Essentially a huge chunk of memory for producing graphics at a higher resolution than usually possible.

### GENLOCK

A simple device which allows the user to overlay computer graphics onto a live or taped TV picture.

### HARRY

A Quantel TV graphics computer which costs £200 per hour to rent, so goodness knows what they cost to buy.

### HIGH BAND

High resolution U-Matic video tape.

### IFF

Stands for Interchange File Format, usually referring (wrongly) to a standard bitmap picture file on the Amiga, more precisely called IFF ILBM files.

### ILBM

Stands for InterLeaved BitMap, a bitmap graphic on the Amiga.

### IRIS

A high end graphics workstation.

### LOW BAND

Low resolution U-Matic video tape.

### SMPTE

Stands for Society of Motion Picture and TV Engineers, and is a special time code for linking any audio and vision in the professional world of movies and video.

### S-VHS

Stands for Super VHS, a high quality version of VHS for use in pro and home environments. The high quality signal comes from coding the picture and colour info separately, reducing the degradation of the final image.

### U-Matic

A professional cassette based videotape format for use in TV studios.

### VHS

A cassette based videotape format for use in the home, which is generally the standard home video format, presumably until something more digital comes along.

### VIDEO 8

A new home use cassette based videotape format, using cassettes no bigger than a normal audio cassette.

# THE CONSOLE ZONE

## NINTENDO GAMEBOY

Konami's *Skate or Die - Bad'n Rad* is the Gameboy version of the popular skateboard-sim from Electronic Arts. You're up against 'EIRad the Evil'. In this seven-level game featuring bazookas, lasers, and, of course, skateboards. Along the way you encounter lava-spitting flying fish, razor-sharp spikes, and cool cat-eating rats - plus a few baddies like Sonic Boomer, Bionic Lester and Sir Slice A Lot. "So get mad, be bad, go rad and spring Miss Aerial from EIRad's feudal fortress," says Konami.

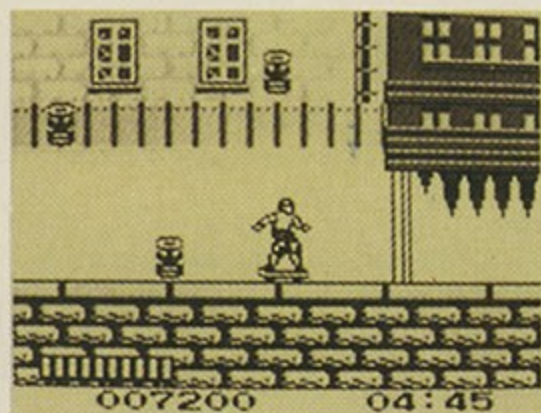

• Skating mayhem from EA for the Gameboy

### PLAYING TIP

Thanks to Damon Barwin of LM Software from Southend-on-Sea, Essex for this *Teenage Mutant Ninja Turtles* tip. You can practise any of the three bonus levels found in the game by pressing [Select], [B] and [A] on the configuration screen. A Question Mark will appear on the far right of the level numbers - just choose this to try any of the bonus games.

Your weekly guide to console gaming with Richard Frederick.

## ZONE COMMENT

What's your favourite video game and why? What conversions would you like and are too expensive? Write to the Consol Zone at the usual address.

## HI-SCORERS

The Console Zone is looking for the best video game players in the world! Can you meet the Console Zone challenge? Send us your scores on your favourite games for the Megadrive, Gameboy, Sega Master, NES, PC Engine, Lynx and Neo-Geo to: The Console Zone, Express, Future Publishing, Bath, Avon BA1 2BW - or fax 0225 446019.

### GAMEBOY

<i>Batman</i>	424,060	Peter Worth
<i>QIX</i>	199,908	Peter Worth
<i>Super Mario Land</i>	331,860	Alex Taylor
<i>TETRIS</i>	396,064	Peter Worth

### MEGADRIVE

<i>DJ Boy</i>	3,531,300	Alex Taylor
<i>Eswa</i>	1,277,900	Alex Taylor
<i>Final Blow</i>	2,525,040	Alex Taylor
<i>Forgotten Worlds</i>	653,900	Alex Taylor
<i>Ghouls 'N' Ghosts</i>	102,400	Alex Taylor
<i>Golden Axe</i>	414.5	Alex Taylor
<i>Super Shinobi</i>	1,968,500	Alex Taylor
<i>Thunderforce III</i>	2,429,100	Alex Taylor

## ATARI LYNX

### PLAYING TIP

The first five *Electrocop* level passcodes:

Level one	DOOR 1: 2473
	DOOR 2: 9874
Level two	DOOR 1: 3287
Level three	DOOR 1: 9284 DOOR 5: 8294
Level Four	DOOR 1: 0394
Level 5	DOOR 1: 8658 DOOR 2: 5462 DOOR 3: 9973
	DOOR 4: 7642 DOOR 5: 0912 DOOR 6: 0974
	DOOR 7: 7865 DOOR 8: 4285

## NEC PC ENGINE

### PLAYING TIP

Password for Map 22 of *Military Madness*: is ARBINE

## SEGA MEGADRIVE



• Try on the New Age Power suit for size

*Axis* is the latest release from leading Japanese games house, Wolf Team. This exciting all-action game places you in control of the New Age Power-Suit (NAP) - a robotic combat machine with outstanding armament, armour and mobility which gives the wearer unheard-of fighting ability. Your NAP can be equipped with up to 15 weapon, speed and manoeuvrability options - out of a choice of 100, including flame throwers, land mines and both hand-held and body-mounted firing gear.

A fight in the 'ultimate battlefield' will cost you 6800 yen.

### PLAYING TIP

Hang-on to this Super-Hang-On passcode: 5723B345135242BCKMCG9D7DDQNL

## NINTENDO ENTERTAINMENT SYSTEM

Five, four, three, two, one - Thunderbirds are go! Activision has produced a video game version of the cult Gerry Anderson adventure puppet TV-show of the sixties. *Thunderbirds* has a complex storyline, enhanced with detailed 'splash-screens' that begin every mission. This is your chance to join International Rescue. All the great Thunderbird vehicles are here, including the Mach 20 Thunderbird 1 Rocket, the Neptune Hydro-TurboJet, even the FireFlash Atomic Plane has been captured in 'super pixelscope' form. The game features volcanic deserts, deadly oceans and poisonous space scorpions as you race to save the world (yet again)!

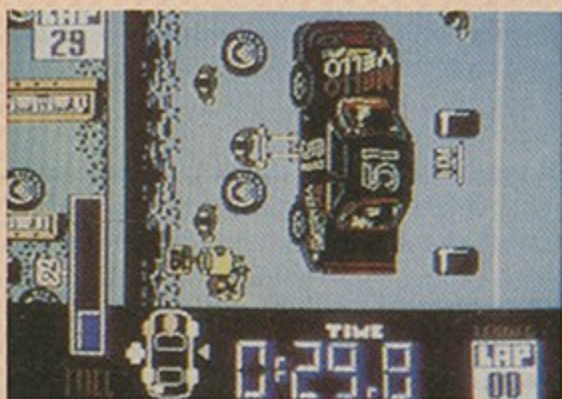

• An action-packed moment from Days Of Thunder

*Thunderbirds* has an immediate ETA but a price point TBA. Over and out.

*Mindscape* in the States has just released an NES game based around the recent Tom Cruise movie, *Days of Thunder*. The game lets you take on the Cruise-role of Cole Trickle as you drive a NASCAR stockcar through eight gruelling races on seven different race tracks in a race to win the Series Cup. During the game you get a full 'three-dimensional' view of each racetrack from a great camera-angle pitched behind and slightly above your own car. That's not all. You also have control of your pit crew - you not only have to race, you've got to change tires, make repairs and refuel in a mad race against your fellow drivers.

*Mindscape* is also working on a Gameboy version of *Days of Thunder*, which is being programmed by Argonaut Software - a British software team previously responsible for the classic 16-bit game *Starglider II*.

### PLAYING TIP

For a full wack of weapons in *Gradius*: pause the game and press [Up], [Up], [Down], [Left], [Right], [Left], [Right].

## SEGA MASTER SYSTEM

### PLAYING TIP

For unlimited Rastan continues: hold down [Button 1], [Button 2] and [Lower Left] during the Sega logo sequence.



★ POCKET SIZED ★ PC-COMPATIBLE ★ PERSONAL ORGANISER ★



# ATARI Portfolio

## THE PC IN YOUR POCKET

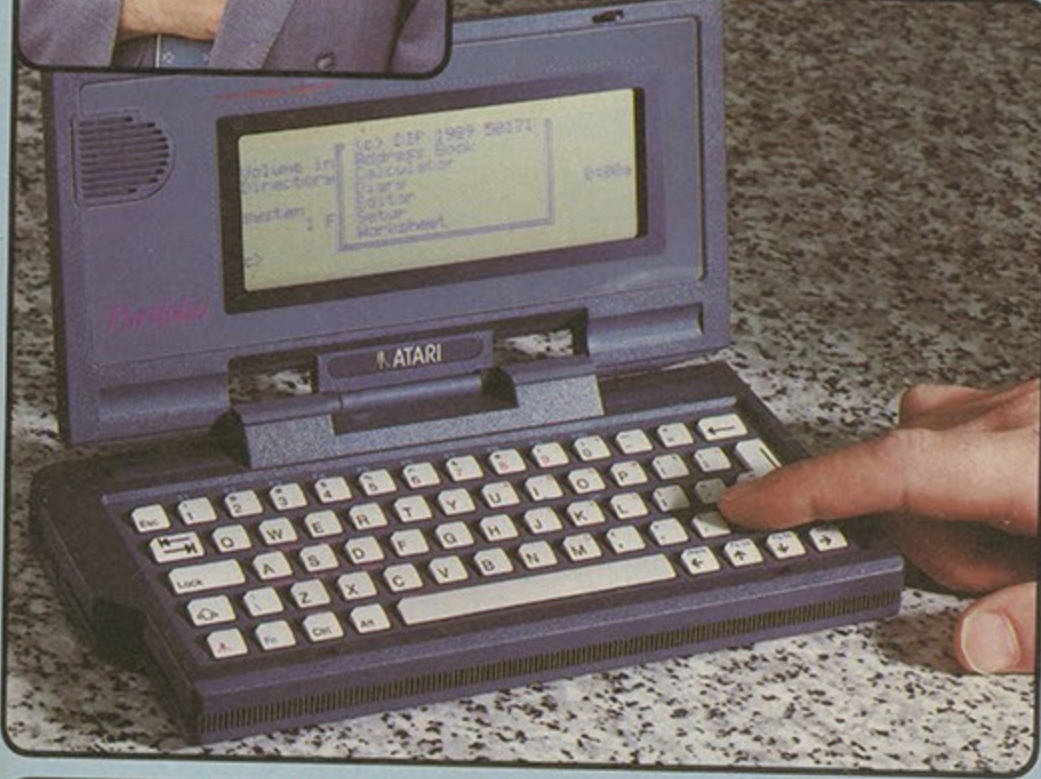

The new Portfolio from Atari is the world's first pocket-sized electronic organiser that is also a powerful PC compatible computer, with a full QWERTY keyboard and scrolling 80x25 character display.

Portfolio includes everything you would expect from an electronic organiser - an address and telephone book, time manager, diary and sophisticated calculator.

Portfolio also includes several functions that you would not expect - a spreadsheet for your personal budget and expense records, as well as a text processor for typing memos and letters.

And, because Atari's Portfolio is PC compatible, it can communicate with your desktop PC at home, or in the office. You can transfer files from one to the other, to enable you to update your reports and figures with the Portfolio while you are on the move.

FOR ONLY **£199** INC VAT

### SPECIFICATION

- ★ **Processor:** Intel 80C88 at 4.9152Mhz.
- ★ **Operating System:** Compatible with MS-DOS 2.11.
- ★ **Internal ROM:** 256K containing BIOS, operating system and applications suite.
- ★ **RAM:** 128K with an internal RAM disk, configurable from 8K. Externally expandable to 640K RAM.
- ★ **Keyboard:** 63 keys, QWERTY, IBM PC BIOS compatible. Buried numeric pad and function keys. Optional key click.
- ★ **Character Set:** Extended IBM ASCII (255 characters).
- ★ **Mass storage:** credit card sized memory cards (32K or 64K or 128K RAM).
- ★ **Display:** Graphics LCD, supertwist technology, MDA compatible, 40 columns x 8 lines, 240 x 64 pixels (with the option to window a full 80 x 25 character display). Keyboard controlled contrast.
- ★ **Peripherals:** 60 pin expansion BUS to take serial and parallel ports and memory expansion units.
- ★ **Size:** 8" x 4" x 1" (200mm x 105mm x 29mm).
- ★ **Weight:** 495 grammes (with batteries).
- ★ **Applications:** calendar and diary, address and phone book, Lotus 1-2-3 compatible spreadsheet, text processor, communications software.

## 5 BUILT-IN APPLICATIONS! TO GET YOU ORGANISED!

To get you started, Portfolio comes with a suite of five useful functions built-in, all accessible from a simple menu display.

### TIME MANAGER

More than just an electronic diary, the Portfolio Time Manager enables you to plan your appointments via a comprehensive calendar and diary. It can even be programmed to sound an audible alarm at specific times to remind you of important appointments.

### CALCULATOR

Your Portfolio will be invaluable in the office or at home as a powerful pocket calculator. It has a full range of functions, including factorial,

power and root calculations, all with multi display formats and memories.

### ADDRESS BOOK & DIALLER

Portfolio has a complete address book facility that allows you to store hundreds of addresses and phone numbers. And, at the touch of a button, you can retrieve any one of them, or search for a specific grouping, such as "all Italian restaurants". And, when you are ready to book your table, hold your Portfolio to your telephone mouthpiece and use its special built-in tone dialler to dial the number for you.

### TEXT PROCESSOR

The Portfolio's built-in text processor program

includes word wrap, line and column count, string search, in fact most of the functions you would find in a word processor. It handles printer and word processor control codes and allows easy transfer of files between Portfolio and your desktop PC.

### SPREADSHEET

For real calculating power, Portfolio has a Lotus 1-2-3 compatible spreadsheet built-in. It has 127 columns x 225 rows and reads/writes Lotus V1.0 and V2.01 files, so you can transfer data to and from Lotus 1-2-3 on your desktop PC. The Portfolio's 256K ROM includes MS-DOS and PC BIOS compatible systems software.

### COMING SOON!

In addition to the excellent software built-in to the Portfolio Free of Charge (see right), other software and peripheral products, such as the sophisticated Pocket Finance package and serial/centronics interfaces are available. And it doesn't stop there. Many manufacturers have recognised the potential of the Portfolio and have already started to design new peripherals and software. Products currently under development include: Serial interface with built in mini modem, Apple Macintosh interface, business, utility and programming software plus a range of adventure and battle strategy games. For further free details on the Portfolio range, fill in the coupon below and return it to Silica Systems now.



### MEMORY CARDS

Portfolio can store and retrieve data and programs from its own RAM, or from small credit card size memory cards, that slot into its built-in card drive. The cards are available in three sizes, 32K, 64K and 128K, so you can carry a library of data in your pocket. The card drive also accepts ROM cards, which can contain commercial or custom software.



### POWER SUPPLY

Portfolio is powered by three AA batteries which will run for up to six weeks with normal use, or from the mains using an adaptor. All the peripherals take their power from the Portfolio, so no extra batteries or adaptors are required. A "battery-low" warning and memory back-up ensure that information is not lost when the batteries are changed.

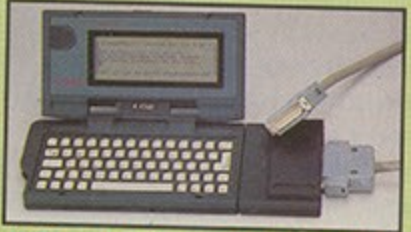

### INTERFACES & PERIPHERALS

Portfolio can communicate with other computers and supports a growing range of peripherals via a built-in 60 pin bus connector. Peripherals available include serial and parallel interfaces and memory expanders (to 640K). You can also add a card drive to your desktop PC, to enable it to read/write to Portfolio's cards.

## SILICA SYSTEMS OFFER YOU

- FREE OVERNIGHT COURIER DELIVERY:** On all hardware orders shipped in the UK.
- TECHNICAL SUPPORT HELPLINE:** Team of Atari technical experts at your service.
- PRICE MATCH:** We normally match competitors on a "Same product - Same price" basis.
- ESTABLISHED 12 YEARS:** Proven track record in professional computer sales.
- £13m TURNOVER (with 60 staff):** Solid and reliable with maintained growth.
- BUSINESS/EDUCATION/GOVERNMENT:** Volume discounts available for large orders.
- SHOWROOMS:** Demonstration and training facilities at our London & Sidcup branches.
- THE FULL STOCK RANGE:** All of your Atari PC requirements from one supplier.
- FREE CATALOGUES:** Will be mailed to you with offers and software/peripheral details.
- PAYMENT:** By cash, cheque and all major credit cards.
- CREDIT PAYMENT TERMS:** Silica are licensed credit brokers - details on request.

Before you decide when to buy your new Atari Portfolio, we suggest you think very carefully about WHERE you buy it. Consider what it will be like a few months after buying your Portfolio, when you may require additional peripherals or software, or help and advice with your new purchase. And, will the company you buy from contact you with details of new Portfolio products? At Silica Systems, we ensure that you will have nothing to worry about. Silica Systems is a new division of Silica Shop, the UK's leading Atari specialists. This new division has been established to provide a service to the more serious home user, as well as to business and education purchasers. Silica have been established for over 12 years, and have an annual turnover of £13 million. With our unrivalled experience and expertise, we can now claim to meet our customers requirements with an understanding which is second to none. But don't just take our word for it. Complete and return the coupon now, for our latest Free literature and begin to experience the "Silica Systems Service".



<b>MAIL ORDER:</b>	1-4 The Mews, Hatherley Rd, Sidcup, Kent, DA14 4DX	Tel: 081-309 1111
Order Lines Open: Mon-Sat 9.00am-6.00pm	No Late Night Opening	Fax No: 081-308 0608
<b>LONDON SHOP:</b>	52 Tottenham Court Road, London, W1P 0BA	Tel: 071-580 4000
Opening Hours: Mon-Sat 9.30am-6.00pm	Late Night: Thursday until 8pm	Fax No: 071-323 4737
<b>SIDCUP SHOP:</b>	1-4 The Mews, Hatherley Rd, Sidcup, Kent, DA14 4DX	Tel: 081-302 8811
Opening Hours: Mon-Sat 9.00am-5.30pm	Late Night: Friday until 7pm	Fax No: 081-309 0017
<b>BUSINESS/EDUCATION:</b>	1-4 The Mews, Hatherley Rd, Sidcup, Kent, DA14 4DX	Tel: 081-308 0888
Order Lines Open: Mon-Fri 9.00am-6.00pm	Closed on Saturdays	Fax No: 081-308 0608

To: Silica Systems Ltd, Dept NCE-1090 38 1-4 The Mews, Hatherley Rd, Sidcup, Kent, DA14 4DX

### PLEASE SEND INFORMATION ON PORTFOLIO

Mr/Mrs/Ms: ..... Initials: ..... Surname: .....

Address: .....

.....

.....

Postcode: .....

Tel (Home): ..... Tel (Work): .....

Company Name: .....

Which computer(s), if any, do you own? .....

E&OE - Advertised prices and specifications may change - please return the coupon to the nearest Silica Systems branch.

**S**urely all computer users have heard of Electronic Arts' *Deluxe Paint* graphics system? Since its release way back in 1985, *DPaint* has asserted itself as the premier paint system for personal computers. Amiga owners were the first to experience its state-of-the-art painting tools, closely followed by PC owners. Now - almost inevitably - it's out on the ST.

What makes *DPaint* so wonderful? Surely paint-packages are all basically the same - plop a pixel here, draw a circle there, drop in a bit of colour and Bob's your uncle! Not quite so - producing a decent paint package is an art form in itself. *DPaint* has earned its enviable reputation from its powerful, flexible and easy to use painting tools. *DPaint* is one of the few paint systems that allows even talentless morons like myself to produce decent artwork. (Well I think it's good!)

### ARTISTECH TALENTS

The ST version of *DPaint* is based on the latest release (version 3) of *DPaint* for the Amiga. Surprisingly, ST *DPaint* wasn't written by the well known author of the PC and Amiga versions - Dan Silva - instead, EA drafted in the services of three talented programmers

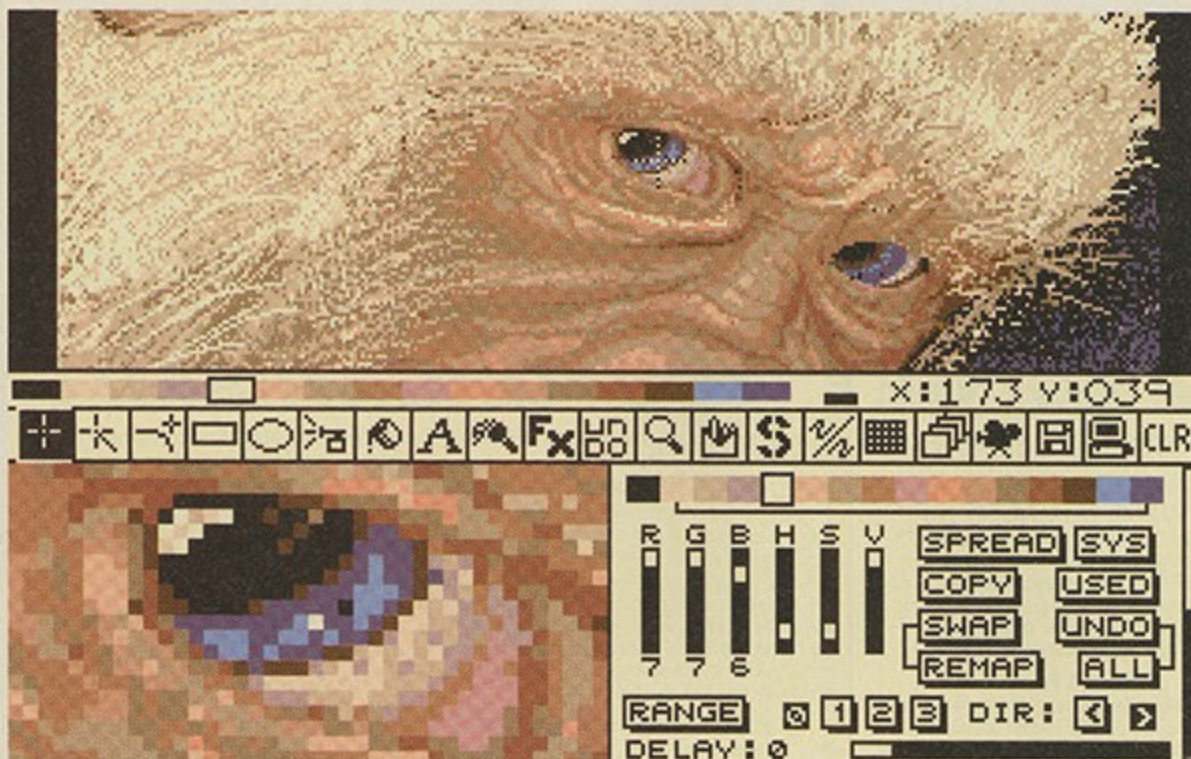

• *DPaint* lets you keep an eye on your colour palette.

who collectively make up ArtisTech Developments, a development house which I'm sure ST owners will be hearing from a lot more in the future.

Instead of opting for a straight port from the Amiga (which wouldn't have necessarily have been a bad thing) ArtisTech decided instead to write ST *DPaint* from scratch, revising many of the program's functions in the process. As a result, the ST version has its own

### MOUSEY MATTERS

The one thing that lets ST *DPaint* down (and indeed any ST paint package) is the quality of the ST mouse - to call it rough would be paying it a compliment. It really is quite impossible to draw smoothly with the ST mouse; regardless of how steady your hand may be, the ST mouse seems to have a mind of its own.

If you're serious about your artwork, then treat yourself to one of the many alternative mice available for the Atari. I use a Naksha mouse - of all the mice I've ever had the pleasure of using, Naksha's unit wins hands down in terms of reliability, resolution and smoothness. Not only that, but the same mouse can also be used on both the ST and the Amiga. This is done by simply resetting a switch located on the mouse's underside.

# NEW KING OF

After almost five years of existence, Electronic Arts' *DPaint* system has finally made it onto the ST. Amiganaut, Jason Holborn checks it out.

unique look and feel. It doesn't even take long to spot those changes - as soon as the program is loaded, they are more than evident.

The most noticeable change is that famous strip of icons that have become the trademark of *DPaint*. Instead of running down the right hand side of the screen, they've been relocated to run horizontally along the bottom of the screen. Most of the icons are identical to those in Amiga *DPaint*, but a re-organising of

the *DPaint* icon strip. Simply by clicking with the right mouse button on any one of the available icons brings up the sub menu for that icon. These sub menus contain all sorts of options for controlling *DPaint's* powerful painting tools. Virtually all of *DPaint's* tools can be customised in some way or another.

### SCREEN SCENE

One of the biggest disappointments of ST *DPaint* is that it only runs in low resolution. Ok, low resolution is arguably the best mode for producing artwork, but why limit yourself? All of *DPaint's* main rivals - *Flair Paint*, *Degas Elite*, etc - work in all three of the ST's screen-modes, so *DPaint* may find itself losing sales to this obvious oversight.

Thankfully though, *DPaint* does fully support the enhanced display hardware of the STE. If you're the owner of Atari's latest baby, then you can take advantage of the STE's 4096 colour palette - although you can obviously still only use sixteen on screen at once.

Colour control has always been a strong point of *Deluxe Paint* and the ST version certainly isn't any different. Palettes can be constructed in a number of ways. The most obvious (but not necessarily the easiest) way is to set up each colour register in turn by setting RGB (or HSV) sliders for that register. An easier way is to use *DPaint's* powerful 'spread' function which allows a range of colours to be set up simply by defining the colour of the first and last registers in the range. *DPaint* then does the hard work of calculating the shades in between.

### THAT BIT BETTER

In terms of basic painting tools, *DPaint's* got the lot. You can draw freehand with any size of pixel brush, draw lines, bezier curves (even the Amiga version doesn't support these!), boxes, circles, fill an area with a colour of your choice, spray graffiti across your masterpiece with the airbrush . . . the list continues. But even with these basic painting tools, *DPaint* still manages to handle them a bit better than the rest.

For starters, they can all be modified in some way

*DPaint's* functions may mean that Amiga (and PC) *DPaint* users will find the ST version somewhat strange at first.

That icon strip has become the workhorse of *DPaint*. All operations are now accessed from the *DPaint* icon strip - gone are the pull down menus of the original. All the functions that previously lived in pull down menus have been moved to sub menus which appear below

### ANIMATION

Animation is a relatively new addition to *DPaint* (Amiga owners didn't get it until version 3), but it still manages to hit the competition for six.

The *DPaint* animation system works on the same principle as the old flip books. By drawing each frame individually, the illusion of movement could be created by rapidly flicking through a large number of frames. You can create animation within *DPaint* by simply drawing each frame in turn, but this can be a laborious task.

To make things simpler, *DPaint* automates much of the process. Just cut out the brush to be animated and then tell *DPaint* where and how you would like the brush to be moved through a specified number of frames. You can move the brush in 3D dimensions and even rotate it in true 3D perspective.

Simply by entering a couple of numbers, you can create such effects as spinning logos with unbelievable ease. For example, if you had a logo you wanted to send spinning into the distance, all you

would have to do is enter something like '1000' for the Z distance, '360' for the Z rotation (this will make the logo rotate full circle as it moves away) and then click on 'DRAW' button - *DPaint* then generates your spinning logo in a matter of seconds. Fantastic or what?

Also included is a handy little utility to convert ST *DPaint* animations for use with the Amiga and PC versions of *DPaint*. At last you can swap not only pictures with your Amiga friend, but animations as well!

# OF ST ART?

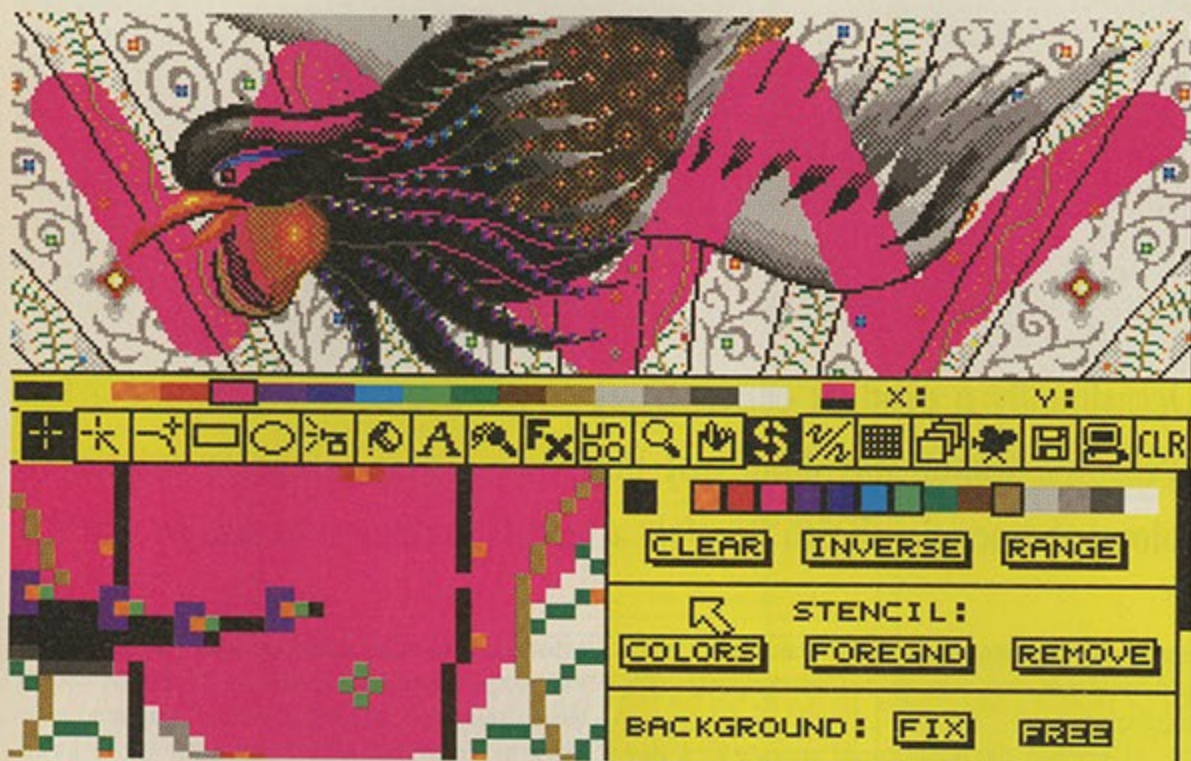

• Mask off any number of different colours within your palette. It's almost like being able to paint 'under' certain colours!

to offer greater flexibility. The airbrush isn't just limited to a single colour spray - you can have up to sixteen colours in your paint pot, varying the population (intensity) of each colour within the spray just by setting a few sliders.

For more precise editing, it's always nice to be able to zoom in on any section of a picture and edit on a pixel-by-pixel basis. *DPaint* uses a zoom window which is displayed below the icon strip. You don't even have to select this to use it - it's there as soon as you load the program (although it can be turned off if you need to view a larger section of your picture at once). Wherever you move the mouse pointer, the zoom window is sure to follow, updating the zoom display as it goes. Ok, nothing special so far, but what makes the *DPaint* zoom facility so wonderful is its speed. Most art packages tend to slow down terribly when moving about with a zoom window open, but *DPaint* handles this task without even a hint of things slowing down. Even when you move the mouse pointer across the screen at high speed, *DPaint* updates the zoom display at a phenomenal speed.

## FONTASTIC COLOUR

One of the most interesting menus within *DPaint* is the FX menu. From here you can alter how *DPaint* lays down colour. As if you were working with 'real' paint or charcoal, you can smear pixels, blend them, smooth



• Not only can you create fantastic artwork with *DPaint*, but you can animate it as well!

them, overlay tints, plus a whole lot more besides. *Degas* has similar functions, but they're nowhere near as powerful as these.

Text control is superb - even the Amiga version could learn a thing or two from *ST DPaint's* powerful text facility. Most ST art packages limit you to the boring



• *ST DPaint* certainly looks different - here's the original Amiga version.

ROM fonts, but *DPaint* offers a wide selection of its own custom fonts. However, what really makes them special is that they can contain up to 16 colours. These colour fonts are great for desktop video - imagine having at your disposal a selection of fonts that look as if they are



• Colour fonts are ideal for applications such as desktop video. Even if you don't like those provide, you can create your own!

## BRUSH STROKES

Messing about with brushes is the thing that *DPaint* does best. Any section of the screen can be picked up and used directly as a brush for painting. Unlike most packages that treat brushes as simple rectangles of colour, the background can be made transparent, therefore allowing you to grab irregular shaped brushes.

Once you've got your brush, you can do all sorts of wonderful things with it. At the simplest level, you can just paint, but *DPaint* offers so much more. It can also be used as a fill pattern for tools such as fill (obviously), circle, box etc. Brushes can also be distorted in a number of ways including skewing, rotating, shrinking and doubling and halving in size.

Unfortunately, even with these relatively powerful tools, brush manipulation isn't a patch on the Amiga version. Amiga owners can perform perspective rotation of a brush, map a brush onto any irregularly shaped area of colour, plus a whole lot more besides. Although *ST DPaint* offers perspective rotation with its animation facility, it doesn't offer anything like the scope of brush manipulation facilities available to Amiga *DPaint* users.

made of different materials - gold, granite, glass, etc. With colour fonts, all this is possible. Even if you're not happy with the fonts that EA provide, you can create your own from within *DPaint*. An edit sub menu allows you to build up entirely new font sets by drawing each character on the screen, cutting it out as a brush and then storing it as a character within the font being edited. You can alter the position of the baseline and even the font's kerning (spacing) type.

## FUN WITH FORMATS

*DPaint* supports both *Neochrome* and *Degas* file formats, so you can import your existing artwork into the program for further editing without having to mess around with PD utilities such as *PicSwitch*. Surprisingly, *DPaint's* native file format isn't an ST file-format at all. Instead, EA has wisely built in support for Amiga IFFILBM files, which means that not only are the pictures that *ST DPaint* produces compatible with Amiga and PC *DPaint*, but you can also load pictures from those machines into *ST DPaint*. Obviously you can't load an Amiga 32 colour picture, but any picture with no more than sixteen colours should load fine. If only everything was as simple as this!

So is *DPaint* the ultimate ST paint system? It sure is. If you can live without high or medium resolution painting (which isn't really too much of a loss anyway), then *DPaint* is quite simply the most powerful ST paint package available - it lacks in some areas, but more than makes up for them in others. Even if you already own an ST paint package, you'd be foolish to miss out on this remarkable paint system. Put simply, no other paint system even comes close. ■

## ADVANTAGES

An absolute wealth of painting tools! Supports *Degas*, *Neo* and even IFF file formats. Blisteringly fast operation. Powerful animation facilities

## DRAWBACKS

Brush manipulation isn't a patch on the Amiga version. Doesn't work in medium or high resolutions.

*Deluxe Paint ST* costs £49.95 from Electronic Arts on 0753 49442. It works on all colour STs and the STE.

# HARD COPY

It's ten years since the first photocopier and a good many more since the first commercial examples of xerography. When the first colour machine appeared some three years ago it was a slow, heavy, cumbersome beast that needed the regular delicate touch of a dedicated engineer and the budget of a small republic to run.

Things have changed and the beast is now a more manageable size, is user friendly enough to let all the staff loose on it and more over, costs a lot less. It was only a matter of time before someone took the scanning and printing abilities of the copier and mated that with the processing power and graphics manipulation abilities of a computer. At a recent update show on the Canon CLC500, we expected to see a working copier and interface and perhaps a computer to show it off. Instead, Canon provided acres of machines, a choice of several computers from a PC, to a Macintosh to a Workstation and brought software developers who had written software and connected the kit to the machines.

### A PICTURE IS WORTH . . .

The technology involved in colour photocopying no longer causes gasps or lives on the secrets list, but to take the copier which is analogue and standardise an interface with the digital world of computing is a race that Canon started, ran and won. The company now dominates more than 75% of the world copier market.

A light grey box, the size of a fat PC tower system sits alongside the copier. A card inside this box contains the clever stuff that takes the scanning and printing abilities of the copier and adds the computing power to make 400x400 dpi imaging possible.

The interface was designed with the use of third party developers in mind and on the day of the launch there were over a dozen different programs and peripherals attached.

Canon linked a still video camera to the interface via the stills player. For the purpose of the demonstration, photos were taken on the camera, the disk was placed in the player and after being displayed on a screen for checking and editing, the image was printed from the copier as a full colour picture. Canon has developed devices to allow a transparency to be printed in this way too, but the most exciting was a peripheral that allowed real time grabbing and storing of image from 35mm cine film.

To demonstrate the versatility of the system, the 400dpi colour images could be printed to a thermal transfer medium and 'ironed' on to any handy fabric. Existing artwork, magazine illustrations, paintings, logos and even fabric were scanned in and printed out on to thermal transfer media (T Shirts with Ed and Tech Ed pix for sale!).

### DEVELOPMENTS AHOY

Because the Canon system uses a standard interface, developers have been able to work around machines and software that they are already familiar with, config-

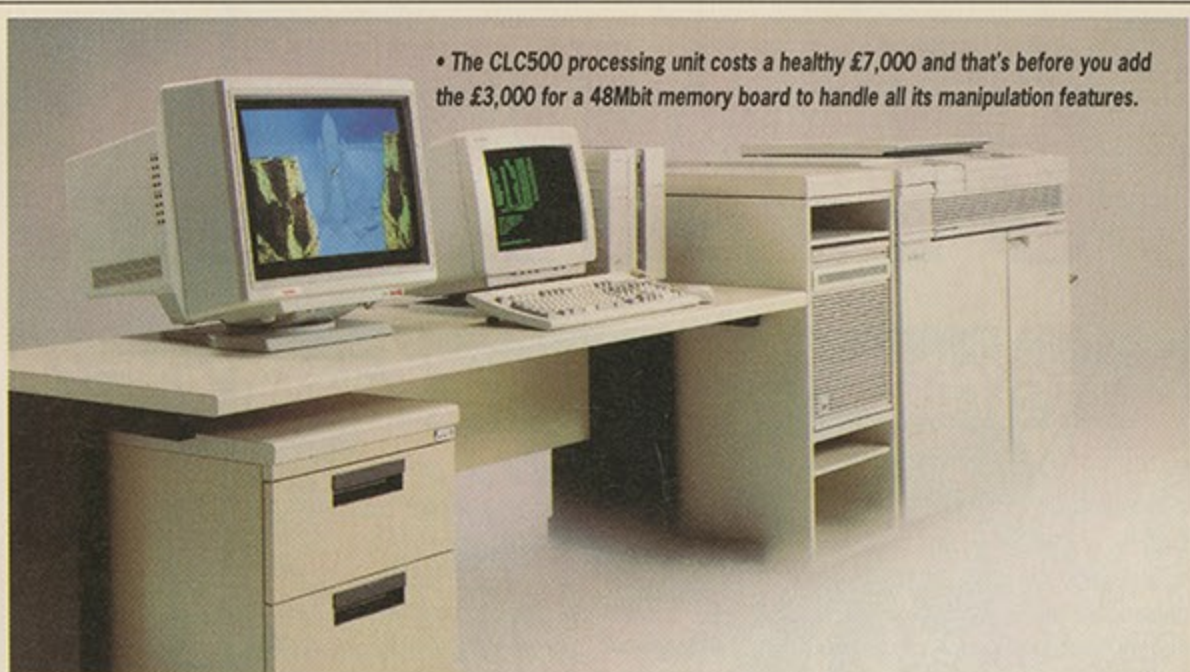

• The CLC500 processing unit costs a healthy £7,000 and that's before you add the £3,000 for a 48Mbit memory board to handle all its manipulation features.

Occasionally a product comes along that raises more than just a few eyebrows. Canon has done just that with a new computer interfaced colour photocopier. Keith Pomfret attempts to reduce his size by 400%.

uring existing systems to work with the Canon Copier and developing new systems that are compatible with existing ones.

At simplest, the colour copier appears as a very clever colour graphics printer with scanning abilities attached to a computer. Most developers, however, take the opinion that it is an important node to an interactive system.

For instance, a textile designer can run a suite of software on a Macintosh designed to take different designs and textures of cloth and make multiple matches without having to go through the expensive

between, for example, cotton and wool and offer a realistic image accordingly. As well as its obvious uses in design studios, in its present form it could scan in an image of a room and allow the operator to overlay different fabrics for drapes, wallpapers and paint colours. With minimal development, it could be transformed into a full environment where colour and texture can match everything from the car to the kitchen.

### PUBLISHER'S CHOICE

Desk top publishing gains a new directness with the Canon system - taking away the time consuming and expensive jobs previously handled by colour reproduction companies.

Any image can be scanned, edited and printed. using still video cameras - it's possible to take pictures and port them straight into a document which can then be printed. Cine and Video film can be scanned and pictures digitised in real time to disk storage.

A company that couldn't consider a short run colour document because of the time and cost involved will now benefit from the ability to produce snappy full colour presentations in-house. The colour copier, with its ability to repro six pages a minute, means immediate decisions can be made from full scale colour proofs.

### THE FUTURE

With the equipment that's now available, a room 10'x10' is large enough for a design studio, editorial, artwork, repro and proof output. One person can finally handle every facet of full colour publishing from one desk.

The open system with its machine compatible interface means that more applications will bolt on to the equipment. The system that includes the necessary interface, processing modules and copier weighs in at £43,000. Of that, around £12,000 is for the copier/scanner. The rest is for the processor and modules.

So far, over a dozen developers have wheeled in their equipment to give an exciting idea a healthy start. There is nothing with which to compare its price to and the value of the equipment that it can replace can be measured in the hundreds of thousands. To take the challenge from Canon's advertising campaign: "Now Copy That!" ■



• As the CLC500 acts as a colour scanner, images can be imported at 24-bit resolution for resizing before being included in DTP documents.



business of weaving and printing. A full colour image of a model can have the cloth and texture of the dress mixed and matched in design, shading and fabric, and the results printed out. These results can be a simple sample of what the cloth will look like or even multiple pictures of the model wearing the finished product for comparison.

The software can tell the difference in texture

Canon (UK) Ltd are located at Canon House, Manor Road, Wallington, Surrey SM6 0AJ. They can be contacted on 081-773 3173.

# THE ATARI ABC

Now, there's a PC-AT compatible that not only solves problems like other AT compatibles, it also solves the one problem that its predecessors have created ... affordability.

Silica Systems are pleased to present the new Atari ABC. The ABC is a 286 AT compatible that runs at over 5 times the performance of the IBM XT. This is achieved by combining the power and speed of a 16-bit 286 processor, with Atari Corp's development experience and engineering capabilities, which use the very latest in design technology. However, the Atari ABC's are available at 'XT prices' and many XT owners will wonder why they paid more, but got less!

The ABC is a reliable, high performance computer, built to exceptionally rigorous standards. It is well designed, to a state of the art specification, maintaining maximum expansion capability for the future. This includes up to 4Mb of RAM and 3 AT expansion slots. Plus, unusually for a PC at this price, the ABC has the ability to install two or three extra drives, with the cabling already inside the CPU.

The ABC has a host of impressive features, all built-in as standard, encouraging simple installation and ease of use. In addition, the ABC's small footprint and quiet operating, mean that you will notice it less on your desk than other PC's. Except, of course, when you begin to take advantage of its AT power.

At its remarkably low price point, the ABC is ideally suited for home, office and educational use and will take full advantage of the vast range of PC compatible software. And, with 12 months FREE on-site maintenance (8 hour response), you can rest assured that your ABC will be fully supported.

The ABC is the latest addition to a comprehensive range of both 286 (8Mhz or 12Mhz) and 386 (16Mhz and 20Mhz) PC's, from the Business Systems Division of Atari Corp. Atari's PC range offers an unsurpassed combination of reliability, compatibility and expandability, with unique features like Atari's 44Mb removable hard disk on their PC4. Return the coupon NOW for further details of the complete range of PC products from Atari's Business Systems Division.

## ABC TURBO

AVAILABLE: JUNE 90

To put the ABC even further ahead of the competition, we have introduced a special 'Turbo' version, which includes a super fast RLL hard disk controller to increase the data transfer rate from 150KBytes/s to 800KBytes/s, with a performance index of 4.801. Plus! to provide exceptional graphics with an outstanding colour resolution of up to 1024x768, we have included a Super VGA graphics adaptor and a 14" VGA colour monitor (which also supports 1024x768 resolution), all for an additional price of only £300. Check the ABC Turbo against the competition, at only £1299 (+VAT) with 30Mb hard disk, Super VGA colour graphics capabilities, plus 12 months on-site maintenance, it offers unbeatable value.

## LOW PRICE - HIGH SPEC!

<b>CPU+MOTHERBOARD</b>	<ul style="list-style-type: none"> <li>8Mhz 80286 16-bit CPU</li> <li>Landmark Speed = 10.3Mhz, Norton SI Test = 9.0</li> <li>Latest NEAT (New Enhanced AT) technology chip set</li> <li>Has user selectable bus, DMA speeds &amp; wait states</li> <li>Programmable to operate at 0 or 1 wait states</li> <li>640K RAM base memory (expandable)</li> <li>Motherboard expandable to 4Mb RAM memory</li> <li>Real time clock with battery back-up</li> <li>Full 16-bit data line capability</li> <li>Socket for 80287-8 numeric Co-Processor</li> <li>3 16-bit AT expansion slots (max)</li> </ul>
<b>DISK</b>	<ul style="list-style-type: none"> <li>32Mb RLL hard disk - 150KBytes/s transfer - 60ms access</li> <li>Fast disk controller - 800KBytes/s transfer - Turbo version</li> <li>1.44Mb built-in 3 1/2" floppy disk drive</li> <li>Space for two 5 1/4" and two 3 1/2" drives (max)</li> </ul>
<b>I/O</b>	<ul style="list-style-type: none"> <li>Parallel port built-in (25-pin Centronics)</li> <li>Serial port built-in (9-pin RS-232)</li> <li>Mouse controller port built-in (9-pin serial)</li> </ul>
<b>GRAPHICS</b>	<ul style="list-style-type: none"> <li>Super VGA video graphics controller - 512K - Turbo vers</li> <li>Super VGA: 256 colours in 800x600 res - Turbo vers</li> <li>EGA video graphics controller built-in</li> <li>EGA: 16 colours available from a palette of 64</li> <li>EGA: 256K of dedicated Video RAM built-in</li> <li>MDA, CGA and Hercules graphics controller built-in</li> </ul>
<b>PHYSICAL</b>	<ul style="list-style-type: none"> <li>Low noise operation</li> <li>Ergonomic small footprint (38cm x 41cm x 15cm)</li> <li>Keyboard - 102 key enhanced AT (12 function keys)</li> <li>Keyboard - has 2 position height adjusters</li> </ul>
<b>PLUS!</b>	<ul style="list-style-type: none"> <li>Fully OS/2 compatible (requires 4Mb RAM)</li> <li>Supports Industry Standard Networks</li> <li>MS-DOS 3.3 with GW BASIC 3.22</li> <li>12 Months FREE on-site maintenance included</li> </ul>

# 286 AT

WITH 30Mb HARD DISK & EGA MONITOR - £899

**FREE!** - ON-SITE MAINTENANCE  
**FREE!** - TECHNICAL SUPPORT HOTLINE  
**FREE!** - TEST/BURN-IN BEFORE DESPATCH  
**FREE!** - OVERNIGHT COURIER DELIVERY

**£899**  
 WITH +VAT  
**30Mb**  
**HARD**  
**DISK**  
 AND  
**EGA**  
**MONITOR**



**ABC TURBO** £1299  
 +VAT  
 • SVGA COLOUR MONITOR  
 • SVGA GRAPHICS CARD - 512K  
 • 30Mb HARD DISK DRIVE  
 • FAST DISK CONTROLLER

**£899** +VAT= £1033.85

**ATARI**

	3 1/2" FLOPPY DRIVE NO HARD DRIVE	3 1/2" FLOPPY DRIVE + 30Mb HARD DRIVE
<b>NO MONITOR</b>	<b>£599</b> +VAT = £688.85	<b>£799</b> +VAT = £918.85
<b>+ EGA MONO</b>	<b>£699</b> +VAT = £803.85	<b>£899</b> +VAT = £1033.85
<b>+ EGA COLOUR</b>	<b>£799</b> +VAT = £918.85	<b>£999</b> +VAT = £1148.85
<b>ABC TURBO</b> AVAIL. JUNE 90	• 14" SVGA COLOUR MONITOR • SVGA GRAPHICS ADAPTOR • FAST DISK CONTROLLER	<b>£1099</b> +VAT = £1263.85
		<b>£1299</b> +VAT = £1493.85

## SILICA SYSTEMS OFFER YOU

**ON-SITE MAINTENANCE (8 hour response):** Available Free of Charge on all ABC's.  
**TECHNICAL SUPPORT HELPLINE:** Team of Atari technical experts at your service.  
**100% QUALITY CONTROL:** Every ABC is tested/burnt-in before despatch.  
**FREE OVERNIGHT COURIER DELIVERY:** On all hardware orders shipped in the UK.  
**ESTABLISHED 12 YEARS:** Proven track record in professional computer sales.  
**£13m TURNOVER (with 60 staff):** Solid and reliable with maintained growth.  
**BUSINESS/EDUCATION/GOVERNMENT:** Volume discounts available for large orders.  
**PRICE MATCH:** We normally match competitors on a "Same product - Same price" basis.  
**SHOWROOMS:** Demonstration and training facilities at our London & Sidcup branches.  
**THE FULL STOCK RANGE:** All of your Atari PC requirements from one supplier.  
**FREE CATALOGUES:** Will be mailed to you with offers and software/peripheral details.  
**PAYMENT:** Cash / cheque / credit card / credit - we are licensed credit brokers - details on request.

Before you decide when to buy your new Atari ABC, we suggest you think very carefully about WHERE you buy it. Consider what it will be like a few months after buying your ABC, when you may require additional peripherals or software, or help and advice with your new purchase. And, will the company you buy from contact you with details of new ABC products? At Silica Systems, we ensure that you will have nothing to worry about. Silica Systems is a new division of Silica Shop, the UK's leading Atari specialists. This new division has been established to provide a service to the more serious home user, as well as to business and education purchasers. Silica have been established for over 12 years, and have an annual turnover of £13 million. With our unrivalled experience and expertise, we can now claim to meet our customers requirements with an understanding which is second to none. But don't just take our word for it. Complete and return the coupon now, for our latest Free literature and begin to experience the "Silica Systems Service".

**SILICA SYSTEMS**

**MAIL ORDER:** 1-4 The Mews, Hatherley Rd, Sidcup, Kent, DA14 4DX Tel: 081-309 1111  
 Order Lines Open: Mon-Sat 9.00am-6.00pm No Late Night Opening Fax No: 081-308 0608

**LONDON SHOP:** 52 Tottenham Court Road, London, W1P 0BA Tel: 071-580 4000  
 Opening Hours: Mon-Sat 9.30am-6.00pm Late Night: Thursday until 8pm Fax No: 071-323 4737

**SIDCUP SHOP:** 1-4 The Mews, Hatherley Rd, Sidcup, Kent, DA14 4DX Tel: 081-302 8811  
 Opening Hours: Mon-Sat 9.00am-5.30pm Late Night: Friday until 7pm Fax No: 081-309 0017

**BUSINESS/EDUCATION:** 1-4 The Mews, Hatherley Rd, Sidcup, Kent, DA14 4DX Tel: 081-308 0888  
 Order Lines Open: Mon-Fri 9.00am-6.00pm Closed on Saturdays Fax No: 081-308 0608

To: Silica Systems Ltd, Dept NCE-1090-28, 1-4 The Mews, Hatherley Rd, Sidcup, Kent, DA14 4DX

## PLEASE SEND INFORMATION ON ATARI PC'S

Mr/Mrs/Ms: ..... Initials: ..... Surname: .....

Address: .....

.....

..... Postcode: .....

Tel (Home): ..... Tel (Work): .....

Company Name: .....

Which computer(s), if any, do you own? .....

# COMPETITION

LASER PRINTER

WIN **£2,000** OF  
PANASONIC LASER PRINTER  
IN THE **EXPRESS** MONTHLY  
GIVEAWAY



The Express monthly competition to win a £2,000 Panasonic laser printer rolls on. This is the next question on the list. Don't forget to keep the token safe for the end of the month.

# WIN! WIN!



# WIN!

QUESTION 3:

What is the nickname of the superfast Japanese train?

- A) Trigger
- B) Missile
- C) Bullet

## WINNERS

The winners of the James Pond competition we ran a few issue ago are as follows:

- Chris Pearn, Macclesfield, Cheshire.
  - Gregor Houghton, Fratton, Pompey.
  - Mrs S J Head, Coulsdon, Surrey.
  - P J Greenwood, Blackburn, Lancs.
  - David Plater, Bridport, Dorset.
  - S May, Deighton, Huddersfield.
  - Stephen Smith, Bridgeford, Notts.
  - Douglas O'Hare, Brighouse, W Yorks.
  - S Lorraine-Francis, Hartcliffe, Bristol.
  - M Westall, Poole, Dorset.
- Spiffingly well done.

## WIN THE NEWEST JOYSTICK ON THE STREETS! £499.80 WORTH OF JIGGLING POWER TO BE WON! EXPRESS HAS 20 TO GIVE AWAY!

I've been doing these competitions for some time now, and yet have never made any introductions. The name is Ms Hanks and I double as the coffee machine operative for the Express staff. You may have read about me in those Centrefold pages. It is my arduous task to have to give things away every week; week in, week out.

This time around I have 20 Spectravideo Mega Board joysticks; and no I don't have one of my own. These things work with any machine you care to mention, well except the PC or a Cray. Each Mega Board comes with two stop watches both of which can count up and down, all the easier to time yourself and your

friends with. You can also vary the autofire speed, all the better to batter the enemy with, not that battering people is a very good idea in my opinion.

The joysticks are due for release in the very near future, but you could be the first person in your conurbation to have one.

All you have to do to win one is answer the following five questions. Send your answers on the coupon to me at the Sheer Joy Competition, *New Computer Express*, 30 Monmouth Street, Bath, Avon BA1 2BW. Entries to be in by Monday November 12 1990. Coupons should be stuck on the back of a postcard or a sealed envelope.

### QUESTIONS

- 1) Where did the band Joy Division originate?
  - A) Leningrad
  - B) Toytown
  - C) Manchester
- 2) Which game was played by a bear of little brain?
  - A) Yogi sticks
  - B) Pooh sticks
  - C) Goldilocks sticks (?)
- 3) Which famous comedienne was known to say "George... don't do that"?
  - A) Joyce Sims
  - B) Joan Sims
  - C) Joyce Grenfel
- 4) A phrase among the criminal fraternity is . . .
  - A) You'll never take me to Rhyl copper
  - B) Look Ma I'm on top of the pops!
  - C) Stick 'em up
- 5) With which piece of software would you NOT use a joystick?
  - A) Lotus 1-2-3
  - B) Kick Off
  - C) Xenon II

There we go. Simply fill in the coupon and send in your answers; and jolly good luck to you all.

NAME.....

ADDRESS.....

The answers are: 1)            2)            3)            4)            5)

Supplementary question for the mystery prize...

"Chaos Theory is fatally flawed because.....

..... (no more than five words).

RETURN THE COUPON FOR FREE COLOUR BROCHURES!

# NEW! - AMIGA PACK

Commodore A500  
Flight Of Fantasy  
**£399**



## A500 BATMAN PACK



The Commodore A500 Batman Pack must surely rank as one of the most popular computer packs ever! The pack features the Commodore Amiga 500 computer with mouse controller and TV modulator, plus four top software titles. The software includes: 'Batman The Movie' - Rid Gotham City of the cunning joker, in Ocean's top selling title based on the blockbuster Batman film; **New Zealand Story** - high quality conversion of the leading arcade game; **Interceptor** - Doglight with two F-16's in this leading flight simulator; **Deluxe Paint II** - top quality Amiga graphics package which set the standard for others to follow. Return the coupon for further details.

**PACK INCLUDES:**

A500 Computer & Mouse	£399.99
A520 TV Modulator	£24.99
Batman The Movie	£24.95
New Zealand Story	£24.95
Interceptor	£24.95
Deluxe Paint II	£49.95

TOTAL RRP: £549.78  
Less Pack Saving: £150.78

PACK PRICE: **£399.00**

**£399** INC VAT

## AMIGA 2000



For the more serious or professional applications user, Commodore have a selection of systems based around the expandable Amiga 2000, at prices from £1295+VAT. The A2000 features a full 1Mb RAM (expandable to 9Mb), 9 system expansion slots, plus IBM compatibility with the use of PC-XT or PC-AT bridgeboards. Complete and return the coupon, putting a tick in the A2000 box, for details of A2000 computer systems.

**£1295**  
+VAT= £1489.25

## FLIGHT OF FANTASY

Flight of Fantasy is the very latest Amiga 500 pack from Commodore, featuring BRAND NEW software releases, to make this the most spectacular A500 pack ever! The pack features the Amiga 500 computer with mouse controller and TV modulator, as well as four top software titles. These include the following:

**DELUXE PAINT II:**

The high quality graphics program that set the standard for other Amiga art packages. Deluxe Paint II includes powerful, easy to use tools that bring out the artist in you. Create masterpieces, presentations, 3D perspectives or just doodle.

**ESCAPE / ROBOT MONSTERS:**

Here's something completely different - a science fiction story with comic book style graphics. Our heroes Jake and Duke are on the Planet X rescuing Humans who have been captured by the Robot Monsters and forced to create an evil Robot Army to DESTROY EARTH! Jake and Duke fight their way through hordes of evil Robots to help the Humans escape.

**RAINBOW ISLANDS:**

Slip on your magic shoes, practise throwing a rainbow and you're ready to go island hopping. From the island of Doh to Monster Island, you will encounter Doh himself, stinging insects, lethal combat machines, mechanical assailants, the formidable beings of legend and folklore. Finally enter the world of darkness and its inhabitants.

**F29 RETALIATOR:**

The ultimate in flight simulation with a choice of two aircraft and four battle environments with dozens of different tactical missions. Aerial combat, strategic bombings, interactive ground based battles, seagoing carriers... the list of features is endless. Real time cockpit displays, including 'true radar' enhance the realistic feel of this stunning simulation.

**PACK INCLUDES:**

A500 Computer & Mouse	£399.99
A520 TV Modulator	£24.99
Deluxe Paint II	£49.95
Escape/Robot Monsters	£19.99
Rainbow Islands	£24.95
F29 Retaliator	£24.95

TOTAL RRP: £544.82  
Less Pack Saving: £145.82

PACK PRICE: **£399.00**

**£399** INC VAT

**FOR FURTHER DETAILS OF THE AMIGA RANGE, COMPLETE THE COUPON AND RETURN IT TO SILICA SHOP THE UK's No1 AMIGA SPECIALISTS**

## SILICA SHOP OFFER YOU

**FREE OVERNIGHT COURIER DELIVERY:** On all hardware orders shipped in the UK.  
**TECHNICAL SUPPORT HELPLINE:** Team of Amiga technical experts at your service.  
**PRICE MATCH:** We normally match competitors on a "Same product - Same price" basis.  
**ESTABLISHED 12 YEARS:** Proven track record in professional computer sales.  
**£13m TURNOVER (with 60 staff):** Solid and reliable with maintained growth.  
**BUSINESS/EDUCATION/GOVERNMENT:** Volume discounts available for large orders.  
**SHOWROOMS:** Demonstration and training facilities at our London & Sidcup branches.  
**THE FULL STOCK RANGE:** All of your Amiga requirements from one supplier.  
**FREE CATALOGUES:** Will be mailed to you with offers and software/peripheral details.  
**PAYMENT:** By cash, cheque and all major credit cards.  
**CREDIT PAYMENT TERMS:** Silica are licensed credit brokers - return coupon for details.

Before you decide when to buy your new Amiga computer, we suggest you think very carefully about WHERE you buy it. Consider what it will be like a few months after buying your Amiga, when you may require additional peripherals or software, or help and advice with your new purchase. And, will the company you buy from contact you with details of new products? At Silica Shop, we ensure that you will have nothing to worry about. Silica have been established for over 12 years, and have an annual turnover of £13 million. With our unrivalled experience and expertise, we can now claim to meet our customers requirements with an understanding which is second to none. But don't just take our word for it. Complete and return the coupon now for our latest Free literature and begin to experience the "Silica Shop Service".

**RETURN THE COUPON NOW FOR FREE BROCHURES**



**MAIL ORDER:** 1-4 The Mews, Hatherley Rd, Sidcup, Kent, DA14 4DX Tel: 081-309 1111  
Order Lines Open: Mon-Sat 9.00am-6.00pm No Late Night Opening Fax No: 081-308 0608

**LONDON SHOP:** 52 Tottenham Court Road, London, W1P 0BA Tel: 071-580 4000  
Opening Hours: Mon-Sat 9.30am-6.00pm Late Night: Thursday until 8pm Fax No: 071-323 4737

**SIDCUP SHOP:** 1-4 The Mews, Hatherley Rd, Sidcup, Kent, DA14 4DX Tel: 081-302 8811  
Opening Hours: Mon-Sat 9.00am-5.30pm Late Night: Friday until 7pm Fax No: 081-309 0017

**BUSINESS/EDUCATION:** 1-4 The Mews, Hatherley Rd, Sidcup, Kent, DA14 4DX Tel: 081-308 0888  
Order Lines Open: Mon-Fri 9.00am-6.00pm Closed on Saturdays Fax No: 081-308 0608

To: Silica Systems Ltd, Dept NCE-1090-32, 1-4 The Mews, Hatherley Rd, Sidcup, Kent, DA14 4DX

**PLEASE SEND INFORMATION ON THE AMIGA**

Mr/Mrs/Ms: ..... Initials: ..... Surname: .....

Address: .....

Postcode: ..... Tel: .....

Which computer(s), if any, do you own? ..... A2000

E&OE - Advertised prices and specifications may change - please return the coupon for the latest information.

# THE WORLD'S MOST POWERFUL FREEZER-UTILITY CARTRIDGE IS NOW EVEN BETTER

THE NEW **MK II** VERSION IS HERE!!

## Amiga Action REPLAY

STILL ONLY  
**£59.99**  
POST FREE  
FOR THE A500/1000

A2000 VERSION AVAILABLE  
**£69.99**

PLEASE STATE WHICH COMPUTER YOU HAVE WHEN ORDERING

AMIGA ACTION REPLAY SIMPLY PLUGS INTO THE EXPANSION PORT OF YOUR AMIGA AND GIVES YOU THE POWER TO FREEZE MOST ANY PROGRAM, THEN YOU CAN...

### JUST LOOK AT THE UNMATCHED RANGE OF FEATURES

- **SAVE THE ENTIRE PROGRAM IN MEMORY TO DISK**  
Special compacting techniques enable up to 3 programs to fit on one disk. Now saves directly to disk as Amiga Dos - reloads independently of the cartridge - even transfer to hard drive! Works with up to 2 Megs of Ram - even 1 Meg Chip Mem (Fatter Agnus).
- **UNIQUE INFINITE LIFE/TRAINER MODE - NOW MORE POWERFUL**  
Allows you to generate more and even infinite lives, fuel, ammo, etc. Perfect as a trainer mode to get you past that "impossible" level. Very easy to use.
- **IMPROVED SPRITE EDITOR**  
The full Sprite Editor allows you to view/modify the whole sprite set including any "attached" sprites. **RANGE OF IMPROVED FEATURES.**
- **VIRUS DETECTION**  
Comprehensive virus detection and removal features to protect your software investment. Works with all presently known viruses.
- **SAVE PICTURES AND MUSIC TO DISK**  
Pictures and sound samples can be saved to disk. Files are saved directly IFF format suitable for use with all the major graphic and music packages. Samples are displayed as screen waveform.
- **SLOW MOTION MODE**  
Now you can slow down the action to your own pace. Easily adjustable from full speed to 20% speed. Ideal to help you through the tricky parts!
- **RESTART THE PROGRAM**  
Simply press a key and the program will continue where you left off.
- **FULL STATUS REPORTING**  
At the press of a key now you can view the Machine Status, including Fast Ram, Chip Ram, RamDisk, Drive Status, etc.
- **POWERFUL PICTURE EDITOR**  
Now you can manipulate and search for screens throughout memory. Over 50 commands to edit the picture plus unique on screen status

"overlay" shows all the information you could ever need to work on screens. No other product comes close to offering such dynamic screen handling of frozen programs!!

- **MUSIC SOUND TRACKER**  
With Sound Tracker you can find the complete music in programs, demos, etc. and save them to disk. Saves in format suitable for most track player programs. Works with loads of programs!!
- **AUTOFIRE MANAGER**  
From the Action Replay II preference screen you can now set up autofire from 0 to 100%. Just imagine continuous fire power? Joystick 1 and 2 are set separately for that extra advantage!
- **DISKCODER**  
With the new "Diskcoder" option you can now 'tag' your disks with a unique code that will prevent the disk from being loaded by anyone else. "Tagged" disks will only reload when you enter the code. Very useful for security.
- **PREFERENCES**  
Action Replay II now has screen colour preferences with menu setup. Customise your screens to suit your taste. Very simple to use.
- **DISK MONITOR**  
Invaluable disk monitor - displays disk information in easy to understand format. Full modify/save options.
- **DOS COMMANDS**  
Now you have a selection of DOS commands available at all times - DIR, FORMAT, COPY, DEVICE, etc.
- **DISK COPY**  
Disk Copy at the press of a button - faster than Dos Copy. No need to load Workbench - available at all times.
- **BOOT SELECTOR**  
Either DF0 or DF1 can be selected as the boot drive when working with Amiga Dos disks. Very useful to be able to boot from your external drive.

### PLUS A MACHINE CODE FREEZER MONITOR WITH EVEN MORE POWER!!

EVEN MORE FEATURES INCLUDING 80 COLUMN DISPLAY AND 2 WAY SCROLLING:-

- Full M68000 Assembler/Disassembler
  - Full screen editor
  - Load/Save block
  - Write String to memory
  - Jump to specific address
  - Show Ram as text
  - Show frozen picture
  - Play resident sample
  - Show and edit all CPU registers and flag
  - Calculator
  - Help command
  - Full search feature
  - Unique Custom Chip Editor
  - allows you to see and modify all chip registers - even write only registers
  - Notepad
  - Disk handling - show actual track, Disk Sync, pattern etc.
  - Dynamic Breakpoint handling
  - Show memory as HEX, ASCII, Assembler, Decimal
  - Copper Assemble/Disassemble - now with suffix names
- REMEMBER AT ALL TIMES YOU ARE INTERROGATING THE PROGRAM IN IT'S "FROZEN" STATE WITH ALL MEMORY AND REGISTERS INTACT - INVALUABLE FOR THE DE-BUGGER OR JUST THE INQUISITIVE!

#### WARNING 1988 COPYRIGHT ACT WARNING

Datel Electronics Ltd., neither condones nor authorises the use of its products for the reproduction of copyright material.  
The backup facilities of this product are designed to reproduce only software such as Public Domain material, the users own programs or software where permission to make backups has been clearly given. It is illegal to make copies, even for your own use, of copyright material, without the express permission of the copyright owner, or the licensee thereof.

HOW TO GET YOUR ORDER **FAST...**

TELEPHONE (24 Hrs) - **0782 744707** - CREDIT CARD ORDERS

WE WILL DESPATCH YOUR ORDER QUICKLY & EFFICIENTLY TO ENABLE YOU TO START RECEIVING THE BENEFITS OF YOUR PURCHASE WITHIN DAYS, NOT WEEKS.

ORDERS NORMALLY DESPATCHED WITHIN 48 Hrs. ALL PRICES INCLUDE V.A.T. ALL CHEQUES/POSTAL ORDERS MADE PAYABLE TO...



**DATEL ELECTRONICS LTD.,**

GOVAN ROAD, FENTON INDUSTRIAL ESTATE, FENTON, STOKE-ON-TRENT, ST4 2RS, ENGLAND  
TECHNICAL/CUSTOMER SERVICE 0782 744324

