

POPULAR *FIRST WITH NEWS AND REVIEWS!* COMPUTING

55p

AUGUST 3 1989

WEEKLY

SINCLAIR SPEAKS

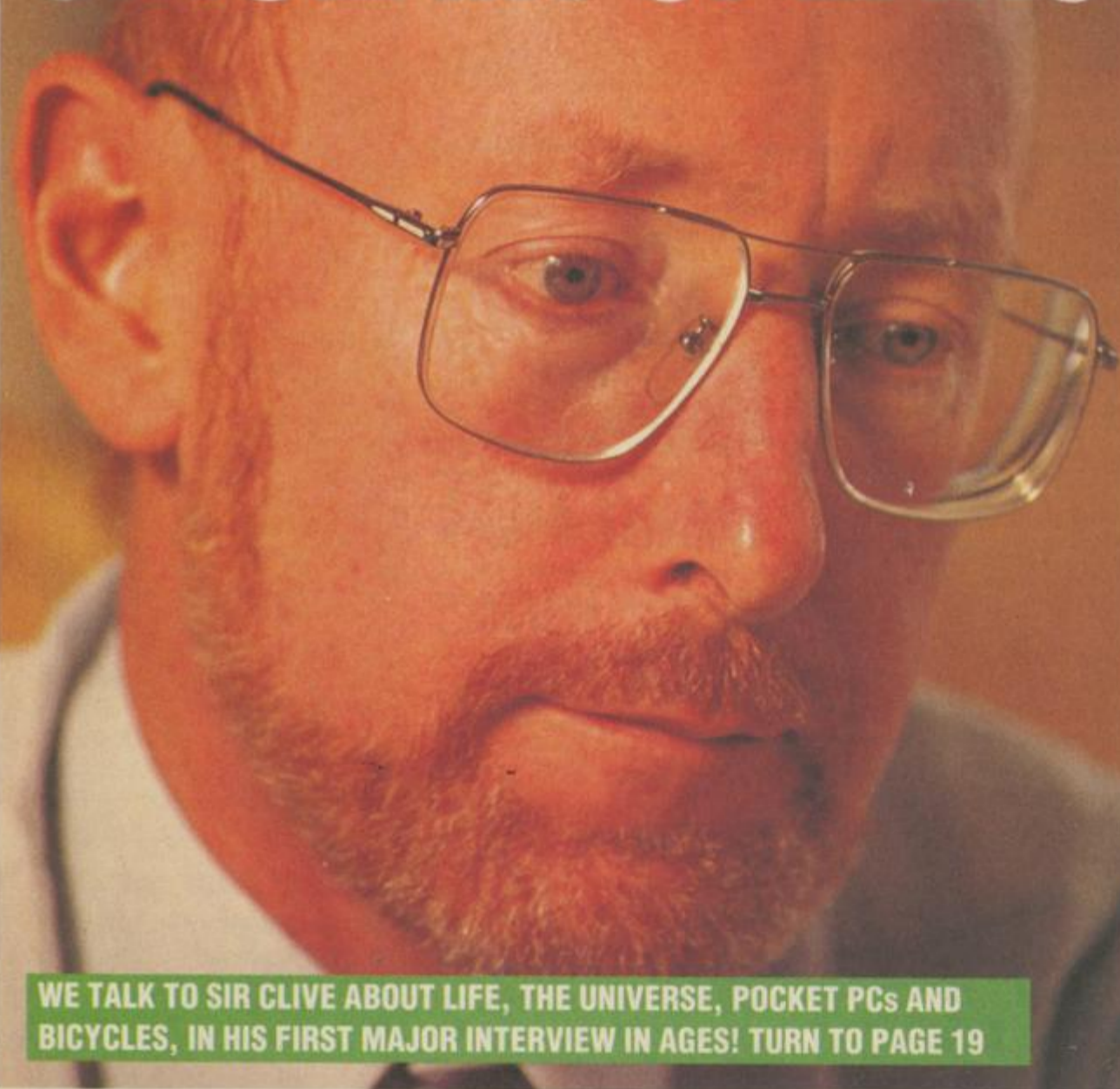

WE TALK TO SIR CLIVE ABOUT LIFE, THE UNIVERSE, POCKET PCs AND BICYCLES, IN HIS FIRST MAJOR INTERVIEW IN AGES! TURN TO PAGE 19



ARCHIMEDES AND BBC NEWS



COMMODORE 64

CD-ROM REVIEW!

- GO COMPACT, p.17

AMIGA

STOPWATCH LISTING!

- TAKE TIME OUT, p.24

ATARI ST

NEW TAX PLANNER

- BEAT THE BLIP, p.10

GAMES

- NEW ZEALAND STORY
- ALIEN LEGION
- FIENDISH FREDDY PREVIEW

ST, AMIGA, SPECTRUM, BBC AND PC PROBLEMS SOLVED, p.36

BUDGETS BURST OUT

TWO NEW budget games labels are being launched this summer, bringing a host of new games and some re-releases to the 8-bit market at £2.99.

Videocoders is the name of a new company set up by Jonathan Edgar. The first games for all the major 8-bit machines are expected to be in the shops at the beginning of September, priced at £2.99. Games will be in cassette format initially with discs probably following later.

Prizes of cash or equipment are promised for the first gamers to complete each game, many of which will be shoot-em-ups. What is described as a "semi shoot-em-up" called 'Boing' is currently top of the list. It runs on the C64 and has over 400 scrolling animated screens.

Edgar, who previously ran a company called Companion producing utilities for the Spectrum, commented:



John Edgar's independent company plans cash promise to quick gamers.

"We are a completely independent company and all our games are original. Once the label is established we will set up a full price label and perhaps deal with 16-bit software as well."

Secondly, this week sees the launch of a new budget label by the man who has previously opened up markets for the likes of Mastertronic, Code Masters and Firebird Silver as a distributor. "We've done it for everyone else so why not do it for ourselves?" commented a company spokesperson.

Now Richard Bielby has formed a new budget label, Cobra, and signed a back-catalogue deal with Gremlin for ten games, all of which will retail for £2.99. The first releases will be MASK, Cosmic Pirate and Kendo Warrior in C64, Amstrad, Spectrum and Atari 8-bit versions. Subsequent releases will be mainly conversions of games already available.



Solid of revolution from Zing.

Mavis on a QWERTY

MINDSCAPE is certainly launching some interesting software lately - following the inimitable *Life and Death* game comes a crop of productivity software. New titles include *Zing*, *Mavis Beacon Teaches Typing* and *The Secretary Bird*.

Zing is a 3-D graphics package for

the PC and Mac that allows user created images to be transported between the two machines. Symmetrical 3-D shapes are created by an outline on an axis which then generated by a solid of revolution by rotating the outline around the axis.

A profiler allows users to draw multiple 2-D cross sections to produce a 3-D image. Priced at £149.99, *Zing* is aimed at DTPers and its image format is compatible with all major packages.

Mavis Beacon Teaches Typing is a tutoring program with a difference, for the Atari ST, Amiga, Apple II GS, Mac or PC. In-built AI routines supposedly tailor your lessons to your ability but Mavis, your innovative instructor, has some pretty neat tricks up her sleeve. One lesson involves a road race, in which you are sent headlong down a race track in a fast car, losing speed (and the game) whenever you make a typing mistake. The price is £29.99.

The Secretary Bird is a four in one office pack for the PC with a WP, spelling checker, database and spreadsheet. The price is £39.99. Mindscape can be reached on 044 486 545.

• *Fiendish Freddy* preview: see page 12 in this issue.

Advertising consolation

EXPECT some well weird Sega ads on your TV soon - Sega has appointed the agency that does the Domestos and

Flora margarine ads to make a series of TV ads - can you imagine the catch lines? *Pop* scribes are wondering what lines the ones-in-loud-braces-and-large-red-framed-specs will come out with. Maybe "Sega - half the fat of other consoles: kills 99 percent of all known alien slime."?

• New Sega games reviewed: page 15.



Dead PC1 may live

JEFF EARL (above), the gregarious new marketing supremo at Commodore, may revive the firm's cheap PC-clone, the PC1, which was priced at £315. The machine died a death this year when supplies dried up after German schools switched over to PC XT's. Commodore Germany, which supplies hardware to the U.K., stopped making the base model.

In the U.K., this has left the Amstrad PC200 at £299 the cheapest PC available. In an exclusive interview with *Popular Computing Weekly*, Earl said he is considering relaunching the 8088-based machine if there is sufficient demand. Future plans for the CBM PC line, says Earl, include battery and mains powered laptops, and two desktops based on the 80386 and 80386SX. Launch dates for the Amiga 2500 and 3000 are still woolly, with no firm dates being offered.

Meanwhile, rival Atari has stated August 25th as launch day for its TT: the 68030 based ST workstation.

This Week

LETTERS p.9

Ecological concern . . . the Lazarus virus . . . Euclid user group . . . and many more missives.

TAX PLANNER, p.10.

ST owners can get to grips with their tax returns using Personal Tax Planner.

PUZZLE, p.10

Divisions among friends.

HOTLINES, p.12

Which computer do you own? Do you conform to Duncan's stereo-types?

NEW GAMES

Fiendish Freddy preview, p.12

The Newzealand Story, p.13

Alien Legion, p.13

Golvellius, p.15

C64 CD GAMES, p.17

Is the new games concept worth the hassle?

SIR CLIVE SINCLAIR INTERVIEW, p.19

The man who has brought mass market home computing to Britain opens up to *Popular Computing Weekly* in this exclusive interview.

BYTES & PIECES, p.24

Stopwatch - a program-timing listing for the Amiga.

BBC SHOW REPORT, p.31

Incorrigible cynic Duncan Evans heads off to the Alexandra Palace.

KENN GARROCH, p.36

Linking the Amiga A500 and a terminal . . . BBC buffers . . . ST mice . . . PC emulators . . . Spectrum joystick interface . . . and more.

FEEDBACK, p.38

A home programmer years for the 'good 'ole days'.

NEW AMIGA, C64 PACKS

EXCLUSIVE details of three new Amiga and C64 bundles have been obtained by *Popular Computing Weekly*.

Independent software publisher, The Disc Company, has put together the packages, which sources insist will not be officially endorsed by Commodore.

There are two Amiga packs and one for the C64 on the cards. These are expected to include:

- The Starter Pack: including an A500, the Kind Words 2.0 word processor package and three games, including *Buggy Boy* and *Crazy Cars*.
- The Home Office Pack, including an A500, the Publisher's Choice DTP package (made up of Kind Words 2.0 plus Pagemaster 1.2) and a database.

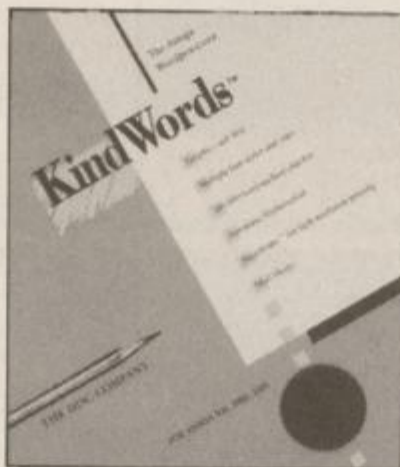

Calling the Home Office with The Disc Company.

- The C64 Test Pilot Pack: this special theme box will include five simulators (not all flight sims) for the C64, includ-

ing *Advanced Tactical Fighter*, from Digital Integration.

Sources suggest that both the Starter and Test Pilot packs are already being test marketed in New Zealand and Belgium respectively, where The Disc Company has subsidiaries.

The packs are expected to be launched in the U.K. either before or during the PC Show - although curiously the Disc Company will not be exhibiting: dealers and distributors are expected to show the products.

Popular Computing Weekly understands that the bundle prices are likely to be as follows: A500 Starter Pack: circa £399, A500 Home Office Pack, circa £449 and C64 Test Pilot Pack, around £150.

Hackers get the message

UNCLE Sam has come down like a ton of bricks on hackers in the last week, with Kevin Mitnick jailed for a year and the announcement that alleged Pentagon virus spreader Robert Morris is to face charges of illegal computer entry.

Mitnick was convicted of using stolen passwords to access computers. He will serve one year in jail and six months in rehabilitation at a halfway house.

Robert Morris, whose alleged worm virus on the Pentagon's Internet affected 6000 UNIX terminals last October, will be charged with illegal manipulation of a 60,000 machine network. The worm program exploited a loophole in UNIX that allowed it to tag itself onto e-mail messages.

Photon Paint under an Illusion

AFTER the wrangle between Activision and Microillusions over who would distribute Photon Paint 2 and Music X in the U.K., it seems that Microillusions, who produce the packages in the U.S., have won out.

The packages have been available in the States for over a year now but have only made appearances this side of the Atlantic in demo form and are in need of de-bugging. However, the products are now in the shops and are being distributed by Microillusions (Europe) which can be contacted on 0480 595605.

Fonetic thisorus faw Ameega

KUMA CLAIM to have the first stand-alone thesaurus for the Amiga. Based on Longman's Pocket Thesaurus, K-Roget has over 150,000 words and phrases allowing users of word processors or even databases to expand their vocabulary.

A phonetic spelling checker looks for alternatives to words based on how they sound rather than how they are

spelt. This is expected to help users whose first language is not English.

Please note that an extra disc drive is required or a hard disc so the standard Amiga is insufficient to run it.

A special offer price of £29.95 inc. VAT applies to K-Roget for the Amiga and for the PC and ST versions already available. Contact Kuma on 07357 4335.

Sculpted Amiga

AN INCREASE of between 300 and 800 percent in basic ray-tracing speeds is claimed for the enhanced graphics package Sculpt 3DXL on the Amiga.

If you relish the power bestowed upon you by Populous, this package allows you to create your own universe, says Martin Lowe of the Amiga Centre, Scotland. Among a host of features are segmented and cubic splines to smooth the joints of organic objects, a range of surfaces including luminous, mirror and metal and Interlace/non-interlace resolutions which are among graphics modes supported.

Contact the Amiga Centre Scotland on 031-557 3260.



The juggling Sculpt 3DXL rendered smooth.



Sam Coupe: develop Z80 code for the micro on an IBM PC.

SAM develops

SOFTWARE developers keen to start creating programs for the long-awaited SAM Coupe, or to convert Z80 software to take advantage of the Coupe's extra graphic and sonic capabilities, will soon be catered for.

Professional software is usually written in assembly language using development systems. Programmer's Development System (PDS), the most popular, runs on PCs and comprises assemblers, software tools and a special interface for the target machine. MGT are collaborating with PDS to produce the development system for the SAM Coupe. It can be used in combination with the Bo Jangeborg graphics package and will be available before the Coupe's launch.

IN BRIEF

Chartbound

RAMPAGE, a new release from console-makers Sega, has shot straight into the Gallup games chart at number 2. Reflecting an increased popularity in console games, Sega attribute their success to a strong list of over 80 games with an average of three to four new ones each month.

Sega's distributor Virgin Mastertronic has announced a new deal with Dixons which will mean the Master System Plus is stocked in all their branches.

Miracom up for sale

MODEM maker Miracom has been put into the hands of receivers while the firm sorts out its troubled finances. Following the failure of a buy-out by the firm's suppliers, US Robotics, receivers Cork Gully has been called in to administer creditors while an alternative buyer is sought. Managing director Gwyn John told *Popular*: "We are the only people who have the approval of US Robotics and I have every confidence we will continue trading." Full warranties apply to all modems sold under the administration of the receivers.

BT takes over Micronet

BRITISH Telecom has announced an increase in its holding of shares in Telemap Group, publishers of Micronet, from 40 percent to 100 percent. John Tomany of the BT Managed Network Services division commented: "Telemap's successful products such as Micronet, InterBusiness, and Shades will form a key sector in our activities."

ST gets TEX-ed

TEX, the document processor and typesetting program designed by Donald Knuth, is now available in public domain for 1MByte Atari STs. It is supplied on four double-sided discs for £10 inc p&p from The South West Software Library, PO Box 562, Wimborne, Dorset BH21 2YD.

ADVANTAGE POPULAR SHAREWARE

FROM £2

- POPULAR TRIED & TESTED PROGRAMS
- THE LATEST VERSIONS
- EASY TO RUN - NO MESSY ARCHIVING
- MONEY BACK GUARANTEE
- FAST DESPATCH - FIRST CLASS

PRICES INCLUDE VAT & POSTAGE

ANY 5 DISCS	£13.25
4 DISCS	£11.25
3 DISCS	£9.45
2 DISCS	£6.95
1 DISC	£3.95

OVER 5 DISCS £2.50 EACH
FOR 3.5" FORMAT
ADD £1 PER DISC

CALL 0242 224340 NOW!

WORD/SPREAD/BASES

- PC-WRITE Oulkssoft's Multi-function word Processor
- PC-TYPE II Brand new WP from Buttonware (HD). 4 DISCS
- PC-TYPE+ Fast Spelling Checker, Undo, Help, 4 DISCS
- SAIL Text editor with windowed multi-file mode
- GALAXY Uke Wordstar but with pull-down menus. 2 DISCS
- MINDREADER Brown Bags unique self-learning WP
- PC-OUTUNE Popular brain storming. Idea processor
- SPELLING CHECKER with updateable dictionary
- PC-CALC+ Powerful multi-feature spreadsheet. 3 DISCS
- AS EASY-AS Spreadsheet which is 123 compatible
- OUBECALC A novel 3-dimensional spreadsheet
- GOALSEEKER Timesaving utility helps create spreadsheets
- PC-FILE+ V2 Popular Database with mailmerge. 3 DISCS
- PC-FILE-dB database power at shareware prices (HD) 3 DISCS
- FILE EXPRESS Easy to use database. 2 DISCS
- INSTANT RECALL Memory-resident database
- 3X5 CARD INDEX simulate manual system (limited sort)
- DREAM Amazing relational database system. 3 DISCS
- WAMPUM Popular, powerful implementation of the dBASE III database programming language (HD) 2 DISCS

FINANCE

- FREEWAY CASHBOOK UK home accounts & budget. 3 DISCS
- FAST BUCKS Comprehensive home accounts & budget. 2 DISCS
- HOME INVENTORY/HOME INSURANCE with report generator
- HOME LOAN Calculate interest, repayments, reports
- FREEWAY PAYROLL Latest up-to-date version. 3 DISCS
- FREEWAY ACCOUNTS PLUS Popular UK Package complete with Purchase, Sales & Nominal Ledgers. 3 DISCS
- MR BILL Customer billing and tracking. 2 DISCS
- TIME & MONEY Financial tracking with cash projection

APPLICATIONS

- LABEL MAKER Simple mailing label database & printing
- PC MAIL Mailing list system and label printer. 2 DISCS
- 100 STANDARD BUSINESS LETTERS to use and adapt
- EZ FORMS standard forms to edit and use
- BUSINESS GRAPHICS Une, Bar Graphs, Pie Charts. 2 DISCS
- STOCK CONTROL SYSTEM Powerful aid to any business
- AUTOMATED PLANNING Useful suite of planning aids
- PROJECT MANAGEMENT Critical Path Analysis, Gantt Charts
- THE FRONT OFFICE Sales tracking system. 2 DISCS
- BUSINESS CONTACTS MANAGER Multi-function suite. 3 DISCS
- ESIE Expert Sytem Shell; Artificial intelligence
- PRO-COMM Menu-driven communications. 2 DISCS
- PC-DIAL Buttonware communications program
- EZ-UNK UK program with full Prestel/Viewdata. 2 DISCS
- WILDCAT Complete Bulletin Board system. 3 DISCS
- STD CODES IN NUMERICAL order with corresp exchanges
- DESK COMMANDO Menu System, DOS shell, Text Editor, Scientific Calculator, Calendar, Appointments Diary
- PC-DESKTEAM Handy calculator, notepak, diary, DOS access
- HOMEBASE Shareware Sidekick. Calculator, WP, Database, Calendar, Notepad, Communications. DOS access. 3 DISCS

EDUCATION

- AMANDA'S LETTER LOTTO (Age 2-4) Teaches keyboard and letter recognition and co-ordination
- ABC FUNKEYS (Age 2-5) Colourful way to learn letters
- AMY'S FIRST PRIMER (Age 3-6) Six games teaching basic letter and arithmetic skills
- CHILDREN'S GAMES (Age 5-8) Five educational games: Alphabet Animals, Clockgame, Hangman and Mosaic
- EDUCATIONAL SELECTION (Age 6-10) Hangman (word guessing), Funnels and Buckets (arithmetic), Polyglot (word matching) and Children's Word Processor
- ANDY'S WORD GAMES Opposites, Word Find, Jobs, Synonyms, Odd Word Out, Categories, Comparisons, Plurals, Verbs (Age 6 up)
- TED'S COMPENDIUM A variety of puzzles, anagrams etc
- PHRAZE CRAZE Learn word and phrase skills (Age 7-12)
- JOTTO Like Master mind only based on words not numbers
- WIZ QUIZ (Age 6-12) Quiz based maths tutorial
- MATHS TUTOR (6-Adult) Covers basic to advanced maths
- PC-TUTOR Well presented course on computers & DOS
- HELPDOS All you need to know about DOS
- FASTYPE Popular multi-option PC typing course
- GCSE PHYSICS REVISION Novel way to learn Physics
- GCSE COMPUTER SCIENCE REVISION Novel way to learn
- STATISTICS Over 20 stat analysis functions. 3 DISCS
- NIGHTSKY The latest computer planetarium. 2 DISCS
- TEST & TRAIN Build your own training program
- Foreign languages each on a single disc: FRENCH TUTOR, GERMAN TUTOR, ITALIAN TUTOR, SPANISH TUTOR

GAMES COMPENDIUMS

Advantage have collected many quality games, grouped by style, under various titles. Most games offer graphics and sound with a choice of keyboard or joystick gameplay.

- CLASSIC GAMES - Space Invaders, Pacman, Pacgirl, Ribit, Breakout, Donkey Kong O-Bert, Jumping Joe
- FUN & GAMES - Pango, Baby, Elevator, Centipede, Pyramid, Dragons, Pac, Osbit
- COME IN PEACE - Striker, Paratrooper, Round 42, Sopwith, Landmine, Hostages
- STAR WARRIORS - Quantoids, Rescue, Flightmare, Kamakaze, Space Wars, Emergency Mission
- KEEP THEM AMUSED Burger Blaster, Grime, Racer, Ninja, Caverns and Galaxy
- FACE THE ACTION Batalia, Tank, Moonbase, Blortill, Gemini
- BLOCK & TACKLE Neron, Oix Xonix, Blockade, Lazer, Berzerk
- GOOD SPORTS PC Tennis, Teed Off (Golf), Yachting in the Bermuda Triangle, Armchair Quarterback (Football)
- SEEK & DESTROY Galactic Conquest, Daleks, Depth Charge, Lazy Monday, Intercept
- SPY CATCHER Master Spy, Brimstone, Mad scientist, Raider
- LOST VEGAS - One Arm Bandit, Roulette, Backgammon, Wheel of Fortune and Blorhythms
- SKILL & STRATEGY - Frigate, Stock Exchange, Big Rig
- WIT YOUR PITS Brainstorm, battleships, 5-in-a-line, Rogue
- MAZING GAMES - Treasure Hunt, Polymaze, Amaze, 3-Demon, Castle, Chase
- PC CHALLENGE - Chess, Othello, Entrap, PCGolf, Hexplode, Air Traffic Controller
- JUNIOR CHALLENGE - 3D TicTatTo, Dotto, Willy The Worm, Labbits & Voldrons, Draughts, MasterMind

Join the Advantage Independent Computer User Group and choose ANY Shareware discs for just £2 each (3.5" format £3 each)

- * PLUS * £2 off each commercial compiler and toolbox package
- * PLUS * monthly newsletters
- * PLUS * technical support

Annual Membership is £15 (EC Countries) £18 (non-EC countries)

SPECIAL INTEREST

- FAMILY HISTORY Reckoned to be best on genealogy. 2
- FAMILY TIES Easy to use Menu-driven Genealogy program
- WEIGHTWATCHER calorie charts, diet and weight planning
- ASTROL-95 Plot astrological charts and horoscopes. 2 DISCS
- BIORHYTHM MONTHLY Comprehensive plotter and printer
- VCR DATABASE for cataloguing videos, LPs etc.
- MICRO MENU Recipe system offers many useful recipes
- MATCH MAKER Now you can start your own dating agency!
- PC SPORT Useful league table generator
- WORLD Extensive gazetteer of places in the World
- CROSSWORD CREATOR all you need to make your own puzzles
- CROSSWORD SOLVER and anagram generator with dictionary
- COMPOSER Create, play and save tunes using on-screen stave
- PIANOMAN Turn your PC keyboard into a musical one
- BIBLE READER Compressed down with easy reader. 5 DISCS
- THE ENTIRE KING JAMES BIBLE in ASCII text. 11 DISCS

PROGRAMMING

- BASIC INTERPRETER Write and run standard GWBASIC
- PASCAL COMPILER A good introduction to Pascal
- MYSTIC PASCAL compiler and editor
- MODULA-2 COMPILER with editor and linker. 3 DISCS
- PROLOG The language for artificial intelligence
- LADYBUG LOGO - Ideal for teaching programming
- BASIC TUTOR Introductory tutorial on BASIC
- GETTING STARTED ON C Introductory lessons and examples
- GETTING STARTED ON ASSEMBLER Useful introduction
- C AND TURBO C TUTOR with source code examples
- CHASM Machine code assembler for the 8086 with Primer
- A86/D86 Powerful 8086 Assembler with debugger. 2 DISCS

ADVENTURES

- GOLDEN WOMBAT OF DESTINY Intriguing and unusual adventure
- JACARANDA JIM Offbeat and amusing UK adventure
- HACK (Amulet Of Yendor). Extensive role-playing adventure
- DUNGEONS & DRAGONS Fantasy role-playing adventure
- COLOSSAL CAVE ADVENTURE The one that started it
- CAVE QUEST sent to Earth to seek fame and fortune
- SUPERNOVA Complex game set in deep space
- INTERCEPT & MUTANT INVASION Two Sci-fi adventures
- DARK CONTINENT & NEBULA Two games by same author
- QUEST FOR KUKULKAN and UNDER THE ICE Two games

DISC ORGANISATION

- POWER MENU Brown Bag's easy to use hard disc menu system
- AUTO MENU Design your own menu for your hard disc
- STILL RIVER SHELL Better front-end than the DOS prompt
- DBS KAT Cataloguing system for hard disc
- DISKCAT Cataloguing system for flopping discs
- DISK COMMANDO Norton utilities at Shareware prices
- ULTRA UTILITIES 'Disc Doctor' with directory of erased files, unerase, sector and file editor
- PROFESSIONAL MASTER KEY New version of this powerful sector and file editor for hard or floppy disc
- PACKDISC Eliminates file fragmentation, economise & speed up your hard disc system
- ARCHIVE SYSTEM Save up to half your back-up discs
- HYPERHELL Menu text presentation and management system
- FLU SHOT Helps you deal with and avoid viruses

UTILITIES UNLIMITED

- ESSENTIAL UTILITIES Over 50 of the best available
- ADVANCED UTILITIES More specialised collection
- USEFUL UTILITIES A further set of over 30 programs
- BAKERS DOZEN Thirteen useful programs from Buttonware
- TEXT PROCESSING Printer Control, Spooler, Print Side-ways, Tally Word Counter, Filters, Fogfinder, Lister
- LASER PRINTER UTILITIES & FONTS. 3 DISCS
- LO Different printer fonts to enhance your Wp text
- FANTASTIC Introduction to DTP with font editor. 2 DISCS
- SIGNSMITH Create your own posters and letter heads

BOARD & CARD GAMES

- SCRABBLE Good implementation of the board game
- SLEUTH Exciting murder mystery solving game
- WORLD DOMINATION The classic game of risk and strategy
- PC-OPOLY Computer version of the well-known board game
- CHESS & CHECKERS Good quality full screen graphic versions
- CHINESE CHECKERS Unusual 6-sided version of draughts
- GAMBLERS DEN Three games - 21, Poker and Pontoon
- BLACKJACK features excellent card pictures and game play
- PUB GAMES Dominoes and Cribbage
- PATIENCE APPLenty 3 games - Solitaire, Pyramid and Sol
- CARD SCHOOL 3 games - Canasta, Gin Rummy & Heart
- MAH-JONG A fascinating taste of the Far East
- TWO BRIDGES Two versions of the card game
- QUIMBEE (YAHTZEE) and FIVE, Two dice-based games

PROJECTS & PASTIMES

- WHEEL OF MISFORTUNE Based on the TV word-guessing game
- OPUS 1 Extensive general knowledge quiz
- TRIVIA QUIZ Many questions, 5 categories. 2 DISCS
- TREK TRIVIA Fascinating quiz based on famous TV series
- BIBLE QUIZ Quiz game based on the Holy Bible
- MUSIC TRIVIA Quiz based on musical questions
- GET LUCKY Adult trivia Quiz and strip poker games
- ADULT HUMOUR Large collection of rather rude jokes
- GAME OF LIFE Fascinating animated graphics game
- PC JOKES A set of funny but harmless practical jokes
- ORIGAMI Study paper folding (needs BASIC interpreter)
- GREETINGWARE DIY computer greeting cards with demos
- SHOWING OFF YOUR EGA Demo screens, animated patterns
- MANDELBROT MAGIC Graphic demonstration and designer
- POPSTAR First in a series of unusual UK games
- SNARF High quality EGA game plus EGA Breakout
- TANK BATTLES A two-player challenge
- STAR TREK II The next generation featuring Morning Cloud
- STAR TREK The original classic game, text & graphics
- PINBALL WIZARD A choice of five different pintables
- PINBALL FANATIC Five more different pintables

ADVANTAGE () 56 BATH ROAD CHELTENHAM GL53 7HJ TEL: 0242 224340

\$tateside

Steve Gold reports on hot news from the U.S.



Apple to unveil Mac lap-top

APPLE will unveil its first lap-top Macintosh later this month at the Boston Macworld Expo in the U.S. The machine which has been code-named Laguna, weighs 14 to 17lb. depending on configuration and is based on a Motorola 68000 microprocessor running at 16MHz.

In its basic configuration, Laguna will have 1MB of RAM and a single 1.44MB 3.5in. floppy drive, pricing from \$3,500 upwards. The top-of-the-range machine, with a 40MB hard disc, internal modem and as much as 5MB of RAM - a great deal for a lap-top - will cost \$6,500.

Part of the reason for the weight of the Laguna is that it is powered by an internal lead-acid battery, just like the heavy one in cars. The LCD screen, however, is more up-to-date, and is a 9.8in. active matrix unit capable of resolving a full Mac monochrome screen. Other features of the Laguna are the same number of I/O ports as the standard Mac S/E, with one expansion board slot and an SE-like Processor Direct Slot.

ST utility

* Maxwell Computer Products Unlimited has announced an interesting Atari ST utility package, *Gogo ST*. The £34-95 package allows almost all ST packages to be run using a single click of the mouse button. Built round a GEM interface, *Gogo ST* presents



Power sat in your lap from Apple.

the user with 15 selection boxes and the ability to load any program name into the boxes.

Other features include a pop-up digital clock, a logging facility and a powerful macro/file finder option. MCPU can be contacted on 0101-303-666-4470.

Super ST

* *Start Magazine* in the U.S. is boasting a world exclusive on the ST Plus, also known as the Super ST. The September issue, due at the end of this month, has an exclusive review on the machine. Details of the machine are sketchy but it is known to be down-

wards-compatible with the existing ST series and has a 4,096-colour palette and eight channel stereo sound as standard features. CPU details on the ST Plus vary, depending on the source. My guess is that the machine will be 68020 microprocessor-based and will have between 1MB and 4MB of RAM. The machine will be unveiled officially during September, suggesting a U.K. Personal Computer Show unveiling on this side of the Atlantic. Pricing is unknown but Jack Tramiel announced previously that the ST Plus will be priced competitively, suggesting a \$1,000 to \$1,200 price in the U.S.

PD pitch

* Also in the pipeline from Atari is an ST package, *Demo Maker*. The public domain package is pitched at software houses and users who want to create a rolling demonstration of ST packages, without the fuss of running the program code proper.

Although *Demo Maker* is aimed at shops for ST window displays, first reports from the U.S. suggest that some enthusiasts are using the package to grab sprites and full screens from protected popular software, to incorporate the code in their programs. The package could bring a whole new meaning to the clone program world. It could also spell trouble for the major games producers.

Amiga animation

* Amiga users are turning to a new public domain and shareware company in the U.S., Premier Software. Premier has amassed one of the largest U.S. collections of PD and shareware software, with the latest hot product, *Lost in Scape*, featuring a 48-second real-time animation for the Amiga.

The three-disc PD package sells for \$12 but requires a full 2MB of RAM to run. Call Premier for a copy of the catalogue on 0101-415-364-4696.

Key revival

* Amiga owners are beginning to re-discover the Control J key when running the CLI. Instead of pressing return after every command line, pressing Control J stores the command until the return key is pressed at the end of several lines. Thus a chain of commands can be stored for rapid execution.

The Control J key was detailed in early Amiga 1000 manuals but, for some strange reason, has not been detailed for A500 and Amiga 2000/2500 series owners. It avoids creating a script file, so it seems a pity that Commodore is hiding this powerful feature from the public. Thanks to John Rydell of the Amy Today on-line newsletter for this long-lost but very useful tip.



The Control J key on your Amiga has hidden assets.

SHOWTIME

SEPTEMBER 27 - OCT. 1 The Personal Computer Show

Earls Court, London
Organiser: Montbuild
Tel: 01-486 1951
Nearest tube: Earls Court

OCTOBER 4 - 6 International Desktop Publishing Show

London Arena, Docklands, London
Tickets by prior application only
Organiser: Database Exhibitions
Tel: (Hotline 0203 470075)
Nearest tube: Cross Harbour (Docklands Light Railway)

NOVEMBER 1 - 4 MacUser Show

Olympia, London
Organiser: Montbuild
Tel: 01-486 1951
Nearest tube: Olympia

NOVEMBER 7 - 9 Computer Graphics '89

Alexandra Palace, London
Organiser: Blenheim Online
Tel: 01-868 4466 ext. 294
Nearest tube: Wood Green

NOVEMBER 11 Alternative Micro Show and Electronics Fair

Bingley Hall, Staffordshire Show Ground
Organiser: Taurus Computer Systems
Tel: 0473 602460
Nearest station: Stafford BR

NOVEMBER 24 - 26 Computer Shopper Show

Alexandra Palace, London
Organiser: Database Exhibitions
Tel: 0625 879966
Nearest tube: Wood Green

CAMBRIDGE INTERNATIONAL SOFTWARE

PRESENTS

**ARCHIMEDES GAMES HYPERPACK
ONLY £699.00 + VAT
(£809.95)**

Includes Mouse, Joystick, (Modulator available), Orion, Thundermonk, Word-up, Word-down, Quazar, Star Trader, White Magic, Hole Out, Pacmania, Terramex, Confusion, Corruption, Jinxter.

Telephone: 01-278 6622

**8 HERBRAND STREET
LONDON WC1**

Supersonic games on the way

STAND BY for some of the most awesome sounds ever produced by a computer game. One of the world's leading synthesizer makers has developed a powerful sound box for use with computers and an American games producer is about to launch a range of products which will use this box to raise games music and sound effects to new levels of sophistication and realism.

The box, devised by the Japanese electronic music giant Roland, comes in several versions. One, the £369 CM32L, is based on the company's popular MT-32 stereo synthesizer module. It offers up to 32 simultaneous notes using eight different musical sounds (chosen from a range of 128) and a rhythm section. For the computer model, a chip with 32 sampled sound effects including

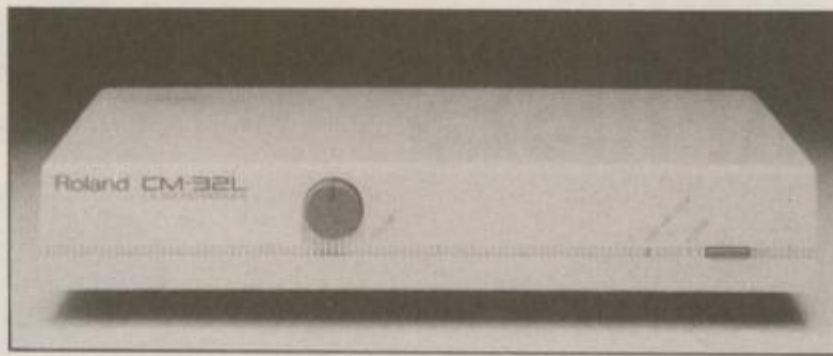

Roland's music box with rhythm section and 128 note range.

gunshots, car noises and screams has been added.

Another version, the £445 CM-32P, is based on Roland's D-110 sample-playing module and comes with 64 high-quality sampled sounds built in. Extra sounds are available on plug-in memory cards. A third module, the £789 CMM-64, is a combination of the first two.

The modules can be driven by any computer using a Midi interface. For IBM PCs and compatibles, a £379 card version of the CM-32L will be available. A Midi interface will add £79 to the price.

George Thorn, manager of Roland's new computer division, says the modules are aimed at computer hobbyists who are put off by the complexities of Midi. In

the next few months, Roland will be launching a series of easy-to-use programs including sequencers and sound editors to go with the modules.

"The idea will be to treat music as a game," explains Thorn. Roland plans to market programs for the Atari ST, the Apple Macintosh and MS-DOS machines. Software prices have not been finalised but are likely to be in the range £100-£200.

The modules will also be supported by several games to be released in coming months by the American software house Sierra. The games, for the ST, Amiga and PC, include the intergalactic adventure *Space Quest III* which will have a soundtrack written by *Supertramp* drummer Bob Siebenberg. The programs will be distributed by Activision.

Warning signs for games loaders?

PRESSURE is mounting on the software industry for it to voluntarily place anti-piracy notices on the front loading screens of all games.

Following a meeting between the Federation Against Software Theft (FAST), copy protection software house Speedlock and duplication house Reflex Magnetics, representations are to be made to ELPSA, the European Leisure Software Publishers Association to get cigarette packet-like warnings placed on software loaders.

David Looker, a director of Speedlock, told *Popular Computing Weekly* that while nobody expects the message

to have a great effect on large scale piracy, the idea is "to reinforce the legal position of software houses when taking legal action against pirates."

By informing users that to copy and distribute the software is illegal, the "I didn't know it wasn't allowed" defence crumbles immediately.

Andrew Hewson, chairman of ELSPA, has yet to hear from FAST: "We've made no official moves on piracy at all yet - we're waiting to hear from FAST; the ball is in their court."

• Do you want to be reminded of piracy each time you boot a game? Write and tell us: see address on page 9.

Blitzed!

Copy protection writers Speedlock claim they have written an Atari ST protection routine which disables the Power Computing Blitz copier - and possibly many other devices. David Aubrey-Jones, co-director of the firm, told *Popular Computing Weekly*: "We've taken a close look at the Blitz and found that, along with older versions of the multiface, we can stop programs being saved to disc." Speedlock's clients include Microprose: all future ST games from Microprose will not succumb to copying with a Blitz device. Aubrey-Jones hopes to be able to block out all copiers soon. Speedlock is on 0734-470303.

The law on copying

THE COPYRIGHT DESIGNS AND PATENTS ACT 1988:
Part 1. Paragraph 107 Section 2.

(2) A person commits an offence who -
(i) makes an article specifically designed or adapted for making copies of a particular copyright work, or
(ii) has such an article in his possession, knowing or having reason to believe that it is to be used to make infringing copies for sale or hire or for use in the course of business.

Until a test case is heard, the 1988 Act is open for interpretation and the legality of copying hardware remains unclear.

POPULAR COMMENT

"If any Amstrad PC dealers want to get in touch with us we're ready to talk business." So said a cheerful Commodore marketing manager, Jeff Earl, clearly gleeful at the thought of his rivals hard disc problems, and the recalls they have caused - see page 3 last week.

But according to dealers, Amstrad's troubles are not particularly good news for home computer companies like Commodore and Atari. The reason is that both firms are trying to be taken seriously as PC suppliers.

The dealers say that the mud is sticking: home computer companies making PCs are being tarred with the brush of the latest PC2000 episode - so perhaps Mr Earl's obvious pleasure at Amstrad's problem is premature. Users feel that perhaps if one consumer market player can get it wrong, so can another.

The home computer boys now have a lot of work to do to regain credibility in the PC stakes. Perhaps that's why Commodore is rethinking its approach to the cheaper end of the market - see page 2.

YOUR CONTACTS

01-834 1717

Editor Paul Marks
News Editor Michael Johnson
Production Editor Dominique Coughlin
Chief Sub-editor Harold Mayes MBE
Art Assistants Paul Ellis, Adrian Hulf
Contributors: Technology: Kenn Garroch. Music/MIDI: Tony Sacks. Comms: Steve Gold, Malcolm Arnold. DTP: Tony Hetherington. Simulators: Lee Paddon. Arcades: John Cook. Adventure: Tony Bridge, Ken Matthews.

Publisher Perry Trevers
Managing Director Peter Welham
Financial Director Brendan McGrath
Chief Executive Richard Hease

Popular Computing Weekly, Greencoat House, Francis Street, London SW1P 1DG. Telephone 01-834 1717. FAX 01-630 6165.
© PCW 1989. ISSN 0265-0509.

Typeset by Hamilton Press. Printed by Southern Print. Distributed by SM Distribution, Streat-ham, London SW16. Telephone 01-677 8111. Subscription rates: UK £35 per year. Overseas £49.95 per year.

Advertising Manager Robert Cole
Asst. Ad. Manager William Saville
Classified Executive Andrew McAngus

UNIQUE ENTERPRISES

For PC
Public Domain Software, Shareware
and Commercial Software

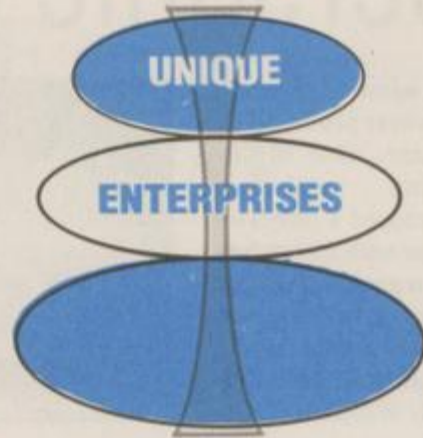

BLANK DISCS (Unformatted)

5 1/4" 27p each
3 1/2" 75p each
(ex VAT)

0292-77884

CASPELL COMPUTER ☎ 0202 666155 [24 hr]

RIBBONS

Amstrad DMP 2/3000 series	2482	A
Amstrad DMP 4000	2426	E
Amstrad PCW8256 (L/Life)	*2741	D
Amstrad PCW9512	*2746	B
Brother HR15/25/40	*2696	B
Canon PW1080A	2223	D
Centronics GLP	2412	D
Citizen 120D/180E/LSP10	2488	B
Citizen MSP-40/50	2477	D
Commodore MPS801	2236	D
Epson FX/LX-80	2273	B
Epson LX/GX-80	2454	B
Epson LO-500	2477	D
Epson RX-80	2273	B
Epson EX-800	2774	D
Epson Full Width	2320	D
Juki 6100 Daisywheel M/S	2563	B
NEC Pinwriter P1/P2	2254	D
NEC P2200	2844	D
NEC P6+/P7+	2870	E
Panasonic KXP-1081/1180	2228	D
Seikosha GP100	2317	B
Seikosha SL80 (L/Life)	*2741	D
Seikosha 500/550	2236	D
Shirnwa CP80/MT80	*2698	D
Tatung/Commodore CP80	*2698	D
Star LC-10	2861	B
Star LC24-10	2868	B
Star NL10	2761	D

Many others - please enquire!
* = Avail. in Fabric Nylon or M/Strike Film.
Please choose!

(Fabrics offer longer life and may be used with Ribbon Refresh! ☞☞☞)

PRICE STRUCTURE

	1 off	2 off	5 off
A	£2.95	£5.75	£12.95
B	£3.95	£7.45	£16.95
C	£4.45	£7.95	£18.45
D	£4.95	£8.95	£16.95
E	£5.95	£10.95	£24.95

Prices include VAT & post

WE ALSO HAVE DISKS

and a Technical Library of 1500 BOOKS!

Please enquire!

FREE SUPPLIES CATALOGUE

24-page FULL BOOKLIST 50p (Only with goods)



PAPER

All prices per 1000 sheets incl. VAT

* P&P £2.50 any quantity

11/9.5 60gsm Listing	£6.45
11/9.5 70gsm Microperf	£7.95
11/9.5 85gsm Letter Qual	£9.95
A4 size 70gsm Microperf	£9.70
A4 size 85gsm Letter Qual	£10.95
11/9.5 2 part NCR	£19.40
A5 size Letter Quality paper, Upright (Portrait) Orientation, Microperf all edges for letter-writing	£13.90

Address Labels

3.5/1.5, 1- or 2- across
£3.75 per 1000 (+£2.50 P&P)

At last - a unique new ink spray that restores ribbons in seconds

SAVE £££s ON RIBBONS

- Quick & Convenient.
- Restores & Re-inks faded ribbons in seconds!
- Refreshed ribbon lubricates print head for smoother running & enhanced printer life.
- Use on any fabric ribbon... again and again!
- Pays for itself the first two times you use it.



ONLY £8.95 inc VAT & post

Cheques/POs (no stamp needed)
CASPELL COMPUTER SERVICES
Dept. P2 FREEPOST, Poole Dorset BH15 1BR
Tel: 0202 666155 or 0202 35650 (24-hr)
TRADE ENQUIRES & LOCAL AUTHORITY ORDERS WELCOMED
Account enquires: 43 Emerson Rd., Poole Dorset BH15 1QS

STAR LETTER

Lead-free in his pencil

I wholeheartedly agree with Derek Wray's sentiments regarding the environment. Yes, hobbies involving modern electronics are more environmentally friendly than some other pursuits but at what cost? Historically, how much damage has been done to the environment to arrive at the present state-of-the-art?

Furthermore, I wonder what proportion of electronic sales are bought by serious hobbyists compared to those buying gadgets in order to 'keep up with the Jones' with no regard to the environmental cost of their manufacture.

You mention the use of unleaded petrol but what of the extra engine wear requiring more frequent replacement - at what cost to the

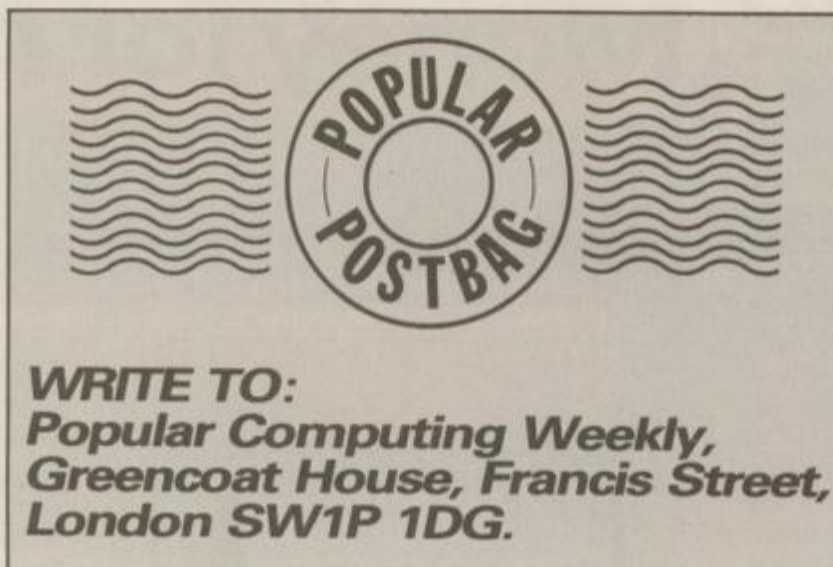

environment - perhaps even greater than using leaded petrol. I could go on...

Perhaps we should uninvent the Infernal Combustion Engine then perhaps the environment may stand a chance if it's not already too late.

Paul A.W. Bruton, Milton Keynes.

Going loco

I have an Amstrad 8256 used for writing a book and virtually nothing else. After changing from Loco 1 to Loco 2, I met the problem of changing layouts for the insertion of quotations and here, although for my purposes only margins and type size are involved and although I can set these up, I cannot get them on to Stock Layout for use next time. Nor can I get back to the original layout without resetting each.

When I worked with Loco 1 I had no such difficulty and, although I have tried to follow the Loco 2 guide, somehow or other I fall down on the process and have reached the point of giving up unless I can get some outside help.

Some of the trouble is that, for my requirement, just too many options

are open. All I want is to change type size and margin, to have this layout named QUOTE (or a number), to bring it up with only one or two actions and, when completed, to get back to Base Layout with a single action. I do not want anything else, which might confuse me.

Charles Jackson, Dyfed.

Stock layouts are changed from the f1 Document set-up menu (where you change the headers). So, once editing your TEMPLATE. STD, press f1 and select DOCUMENT SETUP; then press f2 to select LAYOUT. Then select CHANGE STOCK LAYOUTS. The layout list will then come up: choose your layout and press ENTER. Then edit the layout to your liking. With f7 you can call it QUOTE or whatever. Then press CAN(CEL) and go back to the template. Save it. There it is!

Lost tome

Some time ago I purchased *Decision Maker* from Triptych Publishing Limited, from their BrainPower Application Through Learning series. Unfortunately I have lost the book that accompanied the program and find I am unable to run the program without it.

I have been in touch with Triptych but they say they no longer handle this range so they cannot be of any assistance to me.

I am hoping that perhaps one of your readers could put me in touch with someone who could supply me with the book I need to run the program.

K. Shrimplin, 26 Burt Avenue, Balkwell Estate, North Shields, Tyne and Wear NE29 7HL.



Just say no

This week, after many months of trying to get rid of a virus called SCA and its brethren from my collection, I succeeded. Now, another more prolific virus has reared its ugly head! Has anyone heard of Lazarus? If you have, what can I do to kill it? I can quite honestly say that I possess

No profit

I would like to tell readers that the CP/M & MSDOS Users' Group has published Volume One of its MSDOS Software Library Catalogue. This volume covers the UK MSDOS Library, the PC-Blue Library, Grab-Bag Software, and ALDE Publishing's C CD-ROM.

All this software is now available to members of this group; for details of the catalogue and of membership, please contact Mrs Diana Fordred at 72 Mill Road, Hawley, Dartford,

Kent DA2 7RZ.

Volume Two, *The PC-SIG Library* is at present only available on disc (also from Diana).

The group is a non-profit making members' club, and in addition to its software library, it publishes a journal, runs a book lending library, and provides a bulletin board on Windsor 0753 868196. The protocol is 8-bit, no parity, full duplex, with automatic selection of baud rate. Much of the software is available via the bulletin board.

J.S. Linfoot, Oxford.

Euclidian geometry group

I am writing to inform you of a new user group which has been formed to support users of the Archimedes 3D design program, *Euclid*.

'Elements', as the group is known, will, for an annual subscription of £10, provide a quarterly newsletter including Euclid files, utilities, hints and tips, letters in the form of a disc.

The first issue will be available in October, then January, April and July.

Members will be encouraged to exchange ideas and material through the group in order to increase the effective use of both *Euclid* and the *Archimedes*.

Further membership details are available from *Euclid*'s authors, Ace Computers, on 0223 32255.

Richard Molyneux, *Elements* Organiser.

Lines on Popular

He made the choice to stand in the garden

Sniffing the stench of rotting circuits

The brown, earthy patch was laden with wire,

RAM, disks of data and white DOS attire,

Why is it burning like Grandma's fire?

It was a shame that trusty red brigade never really saved his plethora of Ninjas, his space full of alien vegetables and gravy, his army of ghosts and hereo techno, butch boy fighters, his compassion for computers and his pedestrian sense,

Oh lo! lo! cries of woe!

More sad than sad could ever be grateful

To be reading

Popular! Popular! Oh to be Popular!

Samuel Plunkett, Plaistow.

Money for nothing

Does your taxman have the upper hand?
Andrew Banner reviews an accounting package to help you with alien customs.

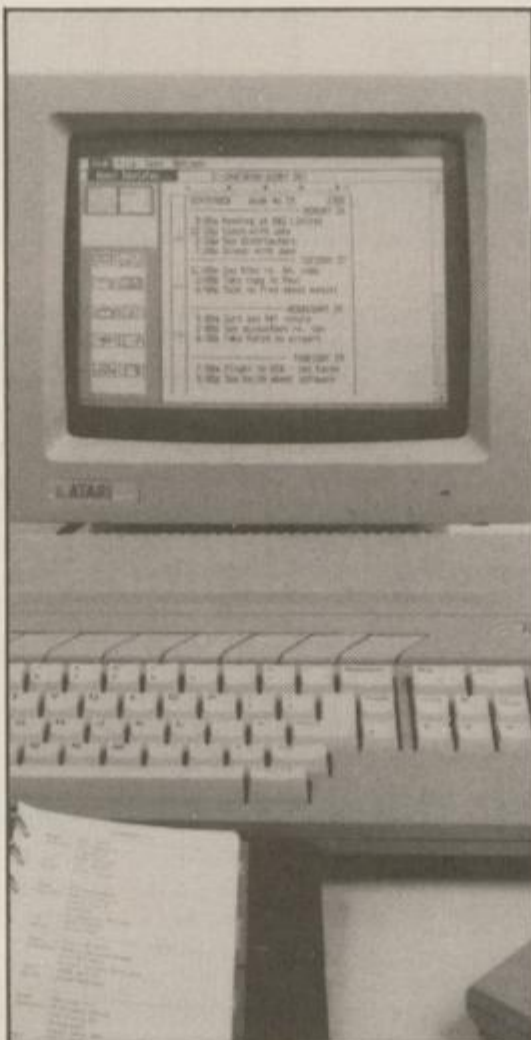

Born free - taxed to death. The statement is true but are you being charged more than your share? The only way to discover that is to spend hours working out your tax returns or to employ an accountant to do the same job. Accountants are not cheap and calculating your own tax can be a headache, especially if you have difficulty understanding the complex system.

Where do you turn? Do you trust that local income tax inspector and hand over your hard-earned wages obligingly, or do you take steps to make sure that you give him only what he deserves?

Personal Tax Planner is a new program from Digita International for the ST. It is also available for IBM and compatibles, Amstrad PCW and Commodore Amiga, and will calculate your tax returns for any given tax year.

Unlike many of the newer personal productivity software packages for the ST, *Personal Tax Planner* is menu-driven as opposed to using the GEM environment. Do not let that deter you before you know what the program can do. The menu system is a tried and tested method of operating software and in this case works very well. I think if GEM were used it might have hampered the use of the software, although it could have looked more presentable.

Designed by an accountant, *Personal Tax Planner* offers the ability to enter, amend, examine and delete data. The data can be in different forms, such as your main income, any extra income, interest received from bank and building society accounts and pensions, although there are many more options. Once you have input all your income for a single tax year you can have the program compute the amount of tax payable on your income. With options to display or print the data, the program will display, in detail, all your income data and then analyse it. Finally, you will be given a figure which is the tax you should have paid. Of course,

you need not enter information about the whole year and can extract certain months.

Income data can be saved to disc and loaded again and there is no file security, no passwords, no compaction of data, no jumbling. In short, anyone can load any compatible file and examine it without difficulty.

The biggest asset of *Personal Tax Planner* is its ability to produce tax returns from what-if? situations. If you were considering a secondary income you could input further data to find the tax payable on your new or prospective income. Once you have reached a figure the data can be deleted to return you to your actual income.

Personal Tax Planner appears to be somewhat limited in its scope at first but the data menus run deep and include many income options. The big let-down of the software is the lack of security and the poor instruction manual, which just skims the surface of the software and provides little information on the country's tax system.

If you are considering this software, remember it is the only one of its kind. After buying it you are likely to need one of the many books on the U.K. income tax system before you can understand the usage of *Personal Tax Planner* fully.

CONTACTS

Digita Integration 0395 270273
Price: £39.95

PUZZLE

"These are interesting numbers", said Ben to Jamie. He wrote three four-digit numbers on a piece of paper and then continued. Now, what I am going to do is to apply a sequence of simple operations to each of these numbers in turn.

Here we have the three numbers:

2169 6501 6921

First we add 1 to each digit in turn, a '9' becoming a zero:

3270 7612 7032

Then we reverse the order of the digits:

0723 2167 2307

Now, we multiply by 3:

2169 6501 6921

"As you can see, this gives us the original three numbers again. In fact, they are the only three numbers having four digits for which this is possible".

"What I would like to know is if it would work for any four-digit numbers if we were to divide by three rather than multiply in the third step?"

Can you help Jamie find any answers?

SOLUTION TO PUZZLE OF JULY 27

Answer: ORANGE = 549270 RED = 403 GREEN = 74002 and INDIGO = 623675.

Solution: In the listing shown, sample values are allotted to each of the letters in turn. Starting with the 'digits' column of the sum, three loops are generated - lines 100 to 140 - to represent the letters E, D and N. In each case a check is carried-out to ensure that each of the values is different from the other two. Once they have been computed as possible values, the value of the letter 'O' can be calculated easily - line 150. This is tested

```

1 REM When typing in this listing don't confuse the letter 'O'
  with the zero (0) or the letter 'I' with the one (1).
100 FOR E=0 TO 9
110 FOR D=0 TO 9
120 IF D=E THEN 390
130 FOR N=0 TO 9
140 IF N=D OR N=E THEN 380
150 Z=E+D+N:Z$=STR$(Z):O=VAL(RIGHT$(Z$,1))
160 IF O=N OR O=D OR O=E THEN 380
170 FOR G=1 TO 9
180 IF G=O OR G=N OR G=D OR G=E THEN 370
190 I=(G*10+E)+(E*10+D)+(E*10+N)
200 Z$=STR$(Z):Z$=RIGHT$(Z$,3):I=VAL(LEFT$(Z$,1))
210 IF Z<>G THEN 370
220 FOR R=1 TO 9
230 IF R=G OR R=O OR R=N OR R=D OR R=E THEN 360
240 I=(N*100+G*10+E)+(R*100+E*10+D)+(E*100+E*10+N)
250 Z$=STR$(I):Z$=RIGHT$(Z$,3):I=VAL(LEFT$(Z$,1))
260 IF I=R OR I=G OR I=O OR I=N OR I=D OR I=E THEN 360
270 FOR A=0 TO 9
280 IF A=I OR A=R OR A=G OR A=O OR A=N OR A=D OR A=E THEN 350
290 OG=O*100000+R*10000+A*1000+N*100+G*10+E
300 RD=R*100+E*10+D
310 GN=G*10000+R*1000+E*100+E*10+N
320 ID=I*100000+N*10000+D*1000+I*100+G*10+O
330 IF OG+RD+GN<>ID THEN 350
340 PRINT STR$(OG);"+";STR$(RD);"+";STR$(GN);"+";STR$(ID)
350 NEXT A
360 NEXT R
370 NEXT G
380 NEXT N
390 NEXT D
400 NEXT E

```

against the letters already in use to check that its value differs.

The program then introduces two more loops, G and R - again carrying-out the necessary cross-checks - and from those values the value of the letter 'I' can be determined - lines 240 and 250. The remaining letter 'A' is then included using the loop at line 270. In this way all possible arrangements of values are computed. Lines 290 to 320 then compute the full values of ORANGE, RED, GREEN and INDIGO respectively. If they agree with the original sum - line 330 - the values are printed-out.

FREE! TENSTAR PACK WORTH OVER £229!

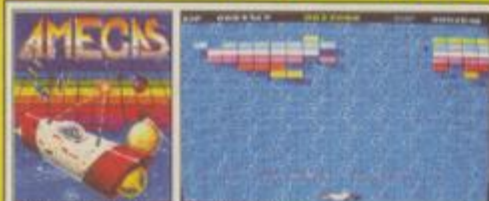

FREE! - AMEGAS - by Players



FREE! - INSANITY FIGHT - by Microdeal



FREE! - ART OF CHESS - by SPA



FREE! - MERCENARY COMP - by Novagen



FREE! - BARBARIAN, ULT WARRIOR - by Palace



FREE! - TERRORPODS - by Psygnosis



FREE! - BUGGY BOY - by Elite



FREE! - THUNDERCATS - by Elite



FREE! - IKARI WARRIORS - by Elite



FREE! - WIZBALL - by Ocean

Commodore AMIGA



ONLY
£3.34
PER WEEK
RETURN COUPON FOR DETAILS

£346.95

+VAT = **£399**
INCLUDES FREE UK DELIVERY

The Amiga 500 is one of a new breed of technologically advanced computers, which are now emerging as the new standard for home computing, based around the new Motorola 68000 chip. The A500 has 512K RAM and a 1Mbyte double sided disk drive built-in. It can be connected directly to a wide range of monitors, or to a domestic TV set through a TV modulator. Designed with the user in mind, the A500 features a user friendly WIMP environment and comes supplied with a free mouse. And, when you buy your Amiga from Silica Shop, the UK's No.1 Amiga specialists, you will experience an after sales service that is second to none, including a technical support helpline and free newsletters and price lists. Return the coupon below for our current information pack, which will give details of the Silica service and the very latest Silica Amiga offers. E&OE

WHY SILICA SHOP?

Before you decide when to buy your new Commodore Amiga computer, we suggest you consider very carefully WHERE you buy it. There are MANY companies who can offer you a computer, a few peripherals and the top ten selling titles. There are FEWER companies who can offer a wide range of products for your computer as well as expert advice and help when you need it. There is ONLY ONE company who can provide the largest range of Amiga related products in the UK, a full time Amiga specialist technical helpline and in-depth after sales support, including free newsletters and brochures delivered to your door for as long as you require after you purchase your computer. That one company is Silica Shop. We have been established in the home computer field for ten years and can now claim to meet our customers requirements with an accuracy and understanding which is second to none. Here are just some of the things we can offer you:

THE FULL STOCK RANGE: The largest range of Amiga related peripherals, accessories, books and software in the UK.

AFTER SALES SUPPORT: The staff at Silica Shop are dedicated to help you to get the best from your Amiga.

FREE NEWSLETTERS: Mailed direct to your home as soon as we print them, featuring offers and latest releases.

FREE OVERNIGHT DELIVERY: On all hardware orders shipped to Silica Shop customers within the UK mainland.

PRICE MATCH PROMISE: We will normally match our competitors offers on a 'same product same price' basis.

FREE TECHNICAL HELPLINE: Full time team of Amiga technical experts to help you with your technical queries.

But don't just take our word for it. Complete and return the coupon below for our latest Amiga literature and begin to experience the Silica Shop specialist Amiga service.

PHOTON PAINT PACK

A500 Computer	£399.99
TV Modulator	£24.99
Photon Paint	£69.95
TenStar Pack	£229.50
TOTAL RRP:	£724.43
LESS DISCOUNT:	£325.43
PACK PRICE INC VAT:	£399

1084S MONITOR PACK

A500 Computer	£399.99
1084S Colour Monitor	£299.99
Photon Paint	£69.95
TenStar Pack	£229.50
TOTAL RRP:	£999.43
LESS DISCOUNT:	£350.43
PACK PRICE INC VAT:	£649

FREE FROM SILICA

When you buy the Amiga 500 from Silica Shop, you will not only get a high power, value for money computer, we will also give you some spectacular free gifts. First of all, we are now including a TV modulator with every A500 stand alone keyboard, so you can plug your Amiga straight into your TV at home (the modulator is not included with the A500+A1084S pack as it is not required for use with monitors). Secondly, we have added a free copy of Photon Paint, an advanced graphics package with an RRP of £69.95. Last (and by no means least!), so that you can be up and running straight away, we are giving away the sensational TENSTAR GAMES PACK with every A500 purchased at Silica Shop. This pack features ten top Amiga titles which have a combined RRP of nearly £230! Return the coupon for details.

FREE TENSTAR PACK

Amegas	£14.95
Art Of Chess	£24.95
Barbarian, Ult Warrior	£19.95
Buggy Boy	£24.95
Ikari Warriors	£24.95
Insanity Fight	£24.95
Mercenary Comp	£19.95
Terrorpods	£24.95
Thundercats	£24.95
Wizball	£24.95
TOTAL RRP:	£229.50
INC VAT	£229.50

TOTAL RRP: £229.50 INC VAT

DO YOU OWN AN AMIGA?

If you already own an Amiga computer and would like to be registered on our mailing list as an Amiga user, let us know. We will be pleased to send you copies of our price lists and newsletters FREE OF CHARGE as they become available. Complete the coupon and return it to our Sidcup branch and begin experiencing a specialist Amiga service that is second to none.

SILICA SHOP:

SIDCUP (& Mail Order) 01-309 1111
1-4 The Mews, Hatherley Road, Sidcup, Kent, DA14 4DX
OPEN: MON-SAT 9am - 5.30pm LATE NIGHT: FRIDAY 9am - 7pm

LONDON 01-580 4000
52 Tottenham Court Road, London, W1P 0BA
OPEN: MON-SAT 9.30am - 6.00pm LATE NIGHT: NONE

LONDON 01-629 1234 ext 3914
Selfridges (1st floor), Oxford Street, London, W1A 1AB
OPEN: MON-SAT 9am - 6.00pm LATE NIGHT: THURSDAY 9am - 8pm

To: Silica Shop Ltd, Dept PCW 3.8.89, 1-4 The Mews, Hatherley Road, Sidcup, Kent DA14 4DX.

PLEASE SEND ME FREE LITERATURE ON THE AMIGA

Mr/Mrs/Ms: _____ Initials: _____ Surname: _____

Address: _____

Postcode: _____

Do you already own a computer
If so, which one do you own?

Who owns computers? What kind of person is it who spends half their lives closeted in a dark room with a piece of machinery? I set off to discover. Spectrum owners are identified by being young and hysterical, or old and still tinkering with the machine they bought when Sir Clive Sinclair created the low-cost computing market. Spectrum owners frequently have modems. Spectrum computer shows are now free-for-all jumble sales.

Commodore 64 folk look worried, haggard and desperate. They look worried because they realise that the C64 is seriously under-powered compared to big

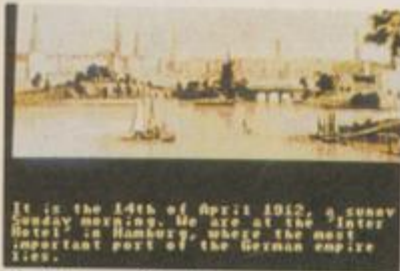

The Mystery of the Mummy.

boy computers and despite advertisements of yesteryear claiming elephantine memory; the sad truth is that it is getting senile.

They look haggard because of the time spent waiting for software to load. Aesop's famous tortoise and the hare fable is in fact

HOTLINES

allegorical – both animals were really Commodore peripherals. Commodore 64 owners are desperate to upgrade but the DTP advertisement is still printing-out.

The average Amiga owner is the smug-looking type at the local computer club. He ditched his 8-bit system only last Christmas but is desperate to convince that he has had 16-bit power for years. Amiga shows are worthy affairs, often attended by vicars, where the grown-ups talk about vertical markets, how genlock is transforming their lives, and try to conceal the children when they start playing the latest game converted from the ST.

If your 8-bit owner votes Labour and the Amiga owners are true blue, your ST owner is the one who has the power and does what he likes. This means enjoying games, a spot of WP, a dab of DTP. ST owners used to be the nouveau riche but after paying £24.95 for



William Tell retold in Crossbow.

games they are now nouveau broke.

Now for something useful. *Crossbow*, the legend of William Tell, is coming from Screen 7 and there is a picture of it on this page. It is all about repression and William's determination to stamp out evil, rescue his son and free the land forever. Load it into your ST, Amiga, PC, C64, Spectrum, CPC and put the Tchaichovsky album on the turntable.

He is a man with a mission, a man determined to stamp out the evil of drug trafficking. He has

obviously seen *Death Wish 4*, another all-format release from Screen 7, coming soon, called *Fallen Angel*.

Artronic has a new driving game coming – check the picture – which is a kind of *Lombard RAC Rally*, without the Lombard RAC. It looks satisfactory and features a world championship and gives you the chance to drive a Spice Engineering SE89C sports car. It retails at £19.99.

Bad news now. The fifth landscape in the Populous expansion disc has been changed from Samurai land to The Bit Plains.

Mystery of the Mummy is a new release from Rainbow Arts and has digitised sepia tone pictures and murders all over the place. It



Fastlane – a legal way to drive drunk.

is your task to sort it all out and unravel the mystery in this intriguing adventure, available on C64 disc, ST, Amiga and PC any time now.

Duncan Evans

PREVIEW

Program: Fiendish Freddy's Big Top 'o Fun

Version: Amiga, ST, PC

Price: Amiga, ST £29.99; PC £34.99

Supplier: Mindscape

Previewer: Andrew Banner

RELEASE DATES

Amiga: September

ST: September

PC: September

Just how many events games can you stand? We have got *Summer Games*, *Winter Games*, *California Games* and even *Caveman Ughlympics* and I am going mad.

The computer scene has been swamped with these type of games but *Fiendish Freddy's Big Top 'o Fun* from Mindscape is an exception. Fortunately for all of us this latest offering is very different.

As the name suggests, the game takes place under the big top and is full of humour. The circus needs to raise \$10,000 in one night to repay an overdue loan. If you fail to find the money,

you lose your circus. To raise money, you need to perform six traditional circus acts. They include the high wire walker, trapeze artist, high diving into ever-diminishing water tubs and the human cannonball.

At the end of the event you are judged by a panel of humorous clown characters, who will award a sum of money according to



• The judges table.

how well you performed in the last event.

Of course, the whole idea of the circus is to get everybody laughing with the slapstick humour so many love and this is exactly what *Fiendish Freddy* does. The judges also employ this laughter method and attack each other constantly. They also change their facial



• Fiendish Freddy's Big tub o'water.

expressions to match their opinions of the past performance.

The loan sharks do not want to see the circus survive and have sent a bully boy – *Fiendish Freddy* – to sort you out. *Freddy* will appear during the event and perform some fiendish trick to try to hamper your progress.

It all adds up to plenty of fun and unlike most other games of this kind, you will never master it or get fed up with it. The more you play it, the more you will discover and the more you will laugh.

Fiendish Freddy's Big Top 'o Fun will be released on the Amiga, ST and PC in September with 8-bit versions to follow later in the year.

F A X B O X

Program: The Newzealand Story
Version: Amiga
Price: £24.99
Supplier: Ocean
Reviewer: Adrian Pumphrey

RELEASE DATES

ST: Out now
Amiga: Out now
Spectrum: Out now
Amstrad: Out now

The title of the game did not prepare me for the sight I received upon booting up this game. I have seen some strange heroes in my time but a laser-toting Kiwi wearing bover boots? I ask you.

The game does not take long to transverse from the sublime to the ridiculous, and every second of the transformation is a sheer delight. The plot is brief and bizarre. A psychotic walrus with a taste for Kiwi has 20 of your friends trapped and lined up for lunch. Escaping from the zoo you set forth with your trusty bow to wreak a

little havoc. The landscape is constructed with a series of platforms inhabited with some very strange characters. In the early stages the common foes are the hermit crab who pops in and out of its shell and throws huge spiked balls and rockets along the platforms.

Next comes the boomerang toting soldiers and something small and furry with pointed ears. While these creatures guard the landward approach to your captured friends the skies are filled with some even stranger sights. These range from bomb dropping bats to owls mounted on ducks, very strange indeed.

With a well placed shot our flightless



• Wally Walrus is a greedy hog.

hero can steal these airborne transporters to take the battle to the skies. And if all this was not enough Kiwi can don a snorkle and enter the briny depths.

The strength of this program lies in its speed – it can take as little as 15 seconds to complete a level – its variety, the sheer weirdness of the monsters and its mixture of cuteness and violence. The bow may not sound very violent but it can be upgraded to more deadlier weapons – and they certainly will be needed when you meet some of the walrus' larger friends.

Gameplay 78%

Grafix 82%

Sonix 70%

Overall

85%

F A X B O X

Program: Alien Legion
Version: Amiga
Price: £24.99
Supplier: Gainstar
Reviewer: Adrian Pumphrey

RELEASE DATES

Amiga: Out Now

Once more the plot is minimal. The Earth has been enslaved and as the lone surviving hero it is your task to introduce the aliens to the finer points of butting laser beams. Before you start this guided tour of war-torn Earth ensure you have an auto-fire on your joystick. A constant stream of laser beams is not only desired but essential.

Your character, Captain Cosmose, can catch a few bullets in his teeth before expiring but nothing grinds down the energy more than running into an alien you should have destroyed.

Occasionally when you terminate an alien a flask is seen floating upwards. If the flask is green, contact with it replenishes lost energy; conversely a red flask removes energy. That can be a little tricky if you kill an alien when it is almost on top of you, as the resulting flask passes through your character before you see its colour. It is bad news

if it is a red flask. The aliens may be small but they get up to all kinds of tricks. Most attack on foot, cannon-fodder style but other more wily bug-eyed monsters ride anything from contraptions better suited to a farmer's field to the latest in fighter technology.

Apart from the creatures which move on two legs, commonly known as bipeds, there are beasties like the fly, hover and creep. They include everything from abstract ships to blinking eyes.

Although the shooting element is crucial the main emphasis is on platforms. Leaping from level to level vertically is satisfactory, so long as you turn off your auto-fire first but leaping across gaps can be a real pain. You have two lengths of jump. Selection between

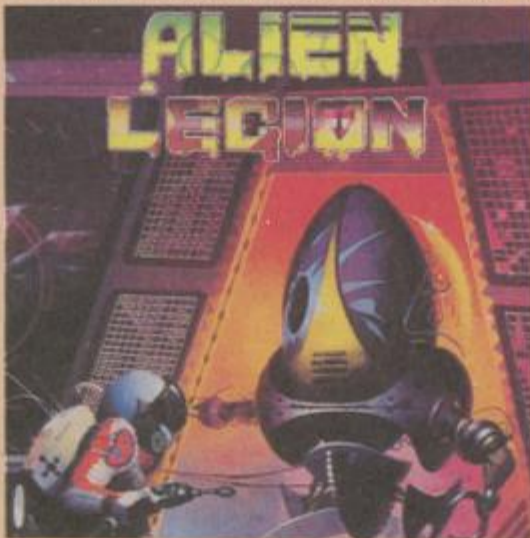

• Easter egg in space.



• Be serious – one green eye and a bit of lead piping doesn't fool me.

the two depends on how long you hold the joystick in the jumping position. Unfortunately in heated moments you tend to opt for the short jump when you need a long jump, thus ending up in the drink. There is nothing outstandingly good or bad about this game.

Gameplay 69%

Grafix 64%

Sonix 60%

Overall

68%

SOFTWARE CLUB INTERNATIONAL

WHY PAY MORE FOR LESS

SUBSCRIBE NOW FOR AWARD WINNING SOFTWARE

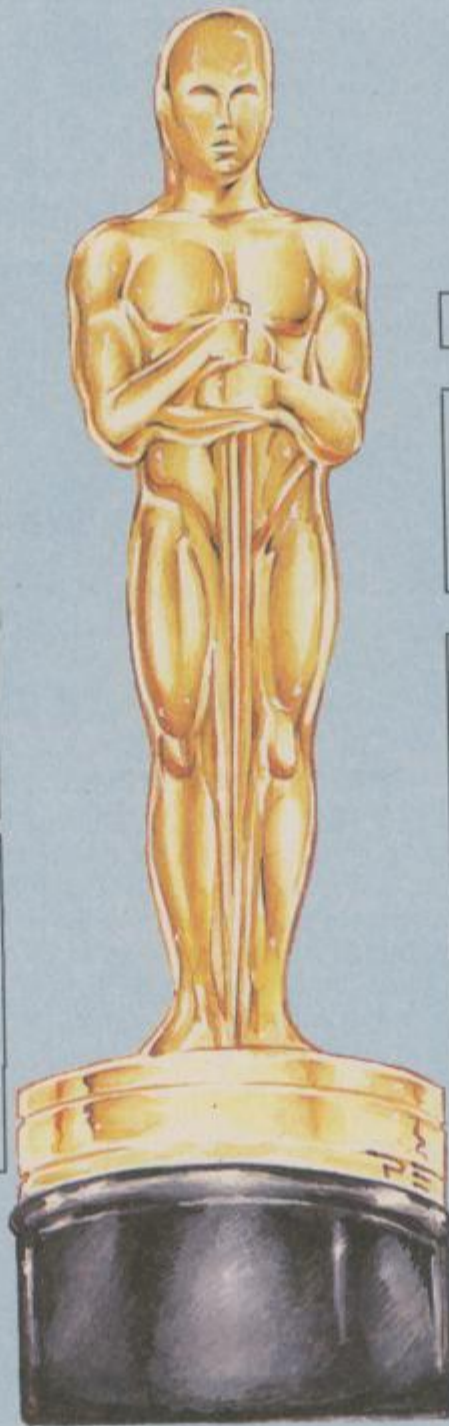

Now for the first time in Europe – the opportunity to enjoy the benefits of the ultimate in Software Club membership

Joining SCI could not be easier. The annual membership fee is just £10 and new members will receive 5 × 5¼" discs or 3 × 3½" discs containing up to 20 quality Shareware programs. All programs are supplied in compressed format on either 5¼" or 3½" discs.

Each month our members receive up to 20 newly released shareware titles carefully selected from around the world by our experts for:

5¼" — £5.95 per month
3½" — £7.95 per month

Fully inclusive of VAT & P & P

Available for:
MS DOS Atari ST Amiga Macintosh

If not 100% satisfied, you can terminate the agreement at any time!

A NEW SERVICE IN SHAREWARE.

With over 12,000 delighted subscribers in the U.S.A. in less than 8 months, we know we've got the balance right!

SPECIAL: FOR MEMBERS ONLY

BLANK DISKETTES
HIGH QUALITY BULK

HIGH CLIP

LIFETIME WARRANTY

MINIMUM QUANTITY 50

5.25" DS/DD 48TPI
25p each = £12.50

MINIMUM QUANTITY 25

3.5" DS/DD 135TPI
79p each = £19.75

SEND TO: SOFTWARE CLUB INTERNATIONAL, 17 SHIRLEY LODGE, 470 LONDON ROAD, LANGLEY, BERKS SL3 3QY

POP6

COMPUTER: PC ATARI ST AMIGA MACINTOSH DISC: 5¼" 3½"

AS A MEMBER OF SCI, I WILL RECEIVE 10/20 PROGRAMS PER MONTH FOR THE NEXT 12 MONTHS.

I AUTHORISE SCI TO DEBIT MY CREDIT CARD EACH MONTH UNTIL FURTHER NOTICE. I CAN CANCEL MY SUBSCRIPTION AT ANY TIME BY GIVING ONE MONTH'S NOTICE IN WRITING. MEMBERSHIP FEE: £10.00

MONTHLY 5¼" — £5.95, 3½" — £7.95

NAME: _____ ADDRESS: _____

CREDIT CARD: VISA ACCESS DINERS CLUB AMEX CARD No. _____

EXP. DATE: _____

SIGNED: _____ DATE: _____

BLANK DISKETTES QUANTITY	PRODUCT	PRICE EACH	TOTAL
_____	50 5¼" DISKETTES	£12.50	_____
_____	25 3½" DISKETTES	£19.75	_____
TOTAL:			£ _____

CHEQUES AND POSTAL ORDERS PAYABLE TO SOFTWARE CLUB INTERNATIONAL (CHEQUES ACCEPTED ONLY FOR BLANK DISKETTES. MEMBERSHIP FEES AND MONTHLY CHARGES PAYABLE ONLY BY CREDIT CARD).

F A X B O X

Golvellius: 73%
 Price: £24.95
 Altered Beast: 42%
 Price: £24.95
 Time Soldiers: 89%
 Price: £24.95
 Reviewer: Duncan Evans

C O N T A C T S

Virgin Mastertronic
 Telephone: 01-727 8070.

Good news for Sega fans is that Virgin Mastertronic, the company responsible for U.K. marketing, has unleashed a plethora of games on to the market. In this first article we look at *Golvellius*, *Altered Beast* and *Time Soldiers*.

I have no idea why the first game is called *Golvellius*, since it is all about the kingdom of Aleid, a drought, a princess who goes missing, the king retiring to his deathbed and the adventures of a youth called something or other. You play that youth, on the quest for the herb to save the king, to find the princess and save the kingdom from the water shortage.

To kick off you have smooth sideways scrolling, with little furry animals gently wandering up to you. You chop them to little furry bits with your sword. That is easy enough and before you know it you are out and on to the second section. Trapped in a valley of your own making, or something like that, we go to command-style perspective, with four-way scrolling and four-way sword play, which is irritating since there are eight-



• *Time Soldiers* – stalking through the undergrowth exercising those commando tactics.



• *Golvellius* – a search for the life giving herb.

way monsters. Pop into the little holes scattered around, suffer some cute vignette of something small and furry and



• *Altered Beast* – or the cat's been at the dustbin again.

usually helpful, then out hacking again, until you have collected seven crystals, whence the gate to the valley of *Golvellius* opens and you are off again. It has average gameplay but pleasant graphics and reasonable sonics.

You may know what it is like when

you have had one drink too many. You are lying dead drunk and some old mystic says rise from the grave and

rescue my daughter and you follow the bloke. Those guys attacking you look as if they have just got out of the ground; and that tiger? Surely that is Mrs Jones' Nibbles from down the road. Dear me, even all the characters are flashing and everything seems to be happening in slow motion.

Alternatively you could play *Altered Beast* because exactly the same thing happens, except that you do not have a hangover in the morning – only the black despair at having wasted

money on this poor effort.

Time Soldiers was much more to our liking. It is all about shooting your way through the various ages of time while hunting for your trapped comrades in the war against someone unpleasant. It is *Commando* time, with vertically-scrolling shooting action, loads of enemies, all tailored to the particular age, throwing all sorts at you.

You half disappear in the bushes and slow down; you are armed with a pea-shooting bazooka and can pick up extra weapons along the way.

Just nail that alligator or prehistoric man and a rocket launcher appears; or a three-way gun or plasma weapon. It just shows those primitives were more advanced than you think.

There are plenty of time zones and on some of them the action switches so that you are scrolling horizontally.

At the end of each level there is a particularly nasty guardian – particularly large as well.

Great graphics, plenty of inventive touches, tough gameplay and satisfying amounts of violence.

Time Soldiers was certainly my pick of this bunch.

★ SUMMER SPECIALS ★

5 1/4" DISKS AND BOX OFFER

25 5 1/4" DS/DD + 100 CAP BOX£11.62
 50 5 1/4" DS/DD + 100 CAP BOX£16.50
 75 5 1/4" DS/DD + 100 CAP BOX£22.50
 100 5 1/4" DS/DD + 100 CAP BOX£28.50
 ALL DISKS 100% CERTIFIED AND GUARANTEED
 ALL BOXES INC. LOCK AND DIVIDERS

3 1/2" DISKS AND BOX OFFER

20 3 1/2" DS/DD + 80 CAP BOX£20.00
 40 3 1/2" DS/DD + 80 CAP BOX£34.50
 50 3 1/2" DS/DD + 80 CAP BOX£40.00
 70 3 1/2" DS/DD + 80 CAP BOX£54.00
 ALL DISKS 100% CERTIFIED AND GUARANTEED
 ALL BOXES INC. LOCK AND DIVIDERS

DISK BOX SPECIAL

INC. LOCKS AND DIVIDERS
 3 1/2" 50 CAPACITY£5.25
 3 1/2" 80 CAPACITY£6.50
 3 1/2" 100 CAPACITY£6.95
 5 1/4" 50 CAPACITY£4.95
 5 1/4" 100 CAPACITY£6.50

DATA SWITCHES

2 WAY 36 PIN CENT£14.50
 2 WAY 25 PIN D TYPE£12.50
 X-OVER 36 PIN CENT£19.22
 X-OVER 25 PIN D TYPE£18.22
 ALL METAL CASE WITH ROTARY SWITCH

DATA SWITCHES/AUTO

5 TO 1 PARALLEL£75.00
 5 TO 1 SERIAL£75.00
 8 TO 1 PARALLEL£95.00
 8 TO 1 SERIAL£95.00
 ALL WITH MANUAL OVERRIDE

DATA CABLES

IBM 25M-36M 2MTR£7.25
 CENT 36M-36M 2MTR£8.25
 RS232 25M-25M 2MTR£7.25
 RS232 25F-25M 2MTR£7.25
 BBC 26IDC-36M 2MTR£4.50

DISK DRIVES

5 1/4" DS/DD 360K JVC£59.00
 5 1/4" DS/DD 1.2 MEG CHINNON£64.00
 3 1/2" DS/DD 720K CHINNON£59.00
 3 1/2" DS/DD 1.44 MEG CHINNON£72.00
 3 1/2" TO 5 1/4" CONVERTER BRACKET £13.75
 ALL DRIVES UNCASSED

UNINTERRUPTIBLE POWER SUPPLIES

350 VA SLIMLINE 10-22 £287.00
 400 VA* 5-15£298.00
 500 VA* SLIMLINE 7/15£350.00
 800 VA* 5/15£556.00
 1000 VA* 5/12£625.00

PRINTER BUFFERS

64K I/P TO 1 O/P£70.00
 64K 2 I/P TO 2 O/P£120.00
 256K 1 I/P TO 1 O/P£140.00
 256K 2 I/P TO 2 O/P£190.00
 256K 4 I/P TO 2 O/P£256.00
 ALL BUFFERS ARE PARALLEL ONLY

MICE AND ACCESSORIES

GENIUS MOUSE GM-6+£35.00
 GENIUS MOUSE GM-6000£49.99
 (BOTH INC. DR HALO III MENU MAKER AND LIBRARY MOUSE PAD AND POCKET)
 RIGID MOUSE MAT Double Sided £4.50
 MOUSE POCKET£2.50

Transfer Time 4 milliseconds
 Overload Protection
 Line Surge Protection
 Noise Attention
 British Standard Output Sockets
 6 Feet Power Cord with Plug
 *Load times full/half load

Protects your Computer system from Power Problems, no more Loss of Data due to Power Failure

ACCESSORIES

A4 ANGLE POISE COPY HOLDER£13.50
 A4 DESK TOP COPY HOLDER£8.50
 12" TILT & TURN MONITOR STAND£10.50
 14" TILT & TURN MONITOR STAND£12.50
 5 1/4" HEAD CLEANER & FLUID£2.50
 3 1/2" HEAD CLEANER & FLUID£3.50
 CPU FLOOR STAND£10.00
 3 1/2" & 5 1/4" LIBRARY CASES PER 5£4.75

CABLE ACCESSORIES

25F-25F GENDER£7.00
 9F-25M AT GENDER£7.00
 25 WAY MINI TESTER£8.50
 25 WAY MINI JUMPER£8.50
 25 WAY NULL MODEM£7.00
 25 WAY 4 PORT GENDER£7.90

PRINTER STANDS

2 PIECE UNIVERSAL£7.95
 1 PIECE 80 Col£9.95

ALL PRICES INCLUDE VAT & P&P UK AND BFPO ORDERS ONLY

Cheques and Postal Orders to:



24 Hours Orderline: 0597 87 784

MANOR COURT SUPPLIES LTD.

Tel: 0597 87 784

DEPT. POP, GLENCELYN HOUSE, PENYBONT,
 LLANDRINDOD WELLS, POWYS LD1 5SY

EDUCATION AND GOVERNMENT ORDERS WELCOME



CD Connection

You have seen the games and now Duncan Evans meets the interface to revolutionise your CD system and C64.

There is no denying that CD technology is all the rage at the moment but with machines like the PC Engine, and companies like Mirrorsoft producing *Defender of the Crown* on CD for PCs leading the way, what Rainbow Arts is about to launch on to the unsuspecting public is rather surprising.

There is a telephone socket on the circuit board and it is used to connect the interface to the LINE-outs on the back of the CD player – or the left or right channel if there is not a specific LINE-out socket.

A word of caution. I tried using my portable Sony Discman but, even with full volume, not even the menu would load. If you have a portable try to check in the shop that it will work before you buy.

The full-size Sanyo had no qualms about interfacing with the C64, though, and after typing LOAD, the menu loaded from the spinning disc in about 40 seconds.

The menu offers 10 games and after selecting one with the cursor keys – joystick use should have been an option – you are given a track number to jump to on the CD player. Once that is accomplished, press the spacebar and the game

take around six-and-a-half minutes, with less than one minute for the original menu, so we are talking 14 minutes of program. That is not exactly exploiting the new technology, is it?

As an added treat there are seven tracks of the dubious musical talent of Chris Hulsbeck, a kind of German David Whittaker, which can be played through your speakers like a regular CD. The computer tunes, to which you listen once only, take another 35 minutes. It says there are 10 of them – in the manual and on the box – but there are not.

So far what you have is a moderately quick – compared to tape – alternative method of loading programs. Except that you can only read from this CD – you cannot save anything on to it, so it has to be treated as nothing except a novel way to load 10 games.

Then you look at the games. You get *David's Midnight Magic* (pinball), *Leaderboard*, *Mission Elevator*, *Impossible Mission*, *Dropzone*, *Lode-runner*, *Solomon's Key*, *Jinks*, *M.U.L.E.* and *FIST II*. Apart from *Jinks*, which was a Rainbow Arts game anyway, the rest of the collection is prehistoric, the newest dating from 1986.

It is at this juncture that you realise that Rainbow Arts has cut every corner and every cost imaginable. What you are paying for is a novel way to load 10 old games – and not particularly fast – from a piece of hi-fi which may need to be dragged round the room before you can connect it. Only if you had a CD player, did not have a disc drive or any of these games and wanted a collection of semi-classics could this strange concept be worth paying for. □



• Above: Frail but ineffective, the interface relaxes on a QWERTY.

• Right: Your CD bundle of 10, but the games are all familiar friends.

1st CD Edition is a package which offers 10 games on a standard CD, a fairly clear instruction manual and a 2½in. by 1½in. interface, all for the Commodore 64. All you have to supply is a very standard lead and a reasonably expensive compact disc player.

The concept behind the package from the West German company more famous for Denaris than any hardware ambitions is that, if you have a C64 but not a disc drive and are looking for faster data access, or faster-loading games in this case, all you have to do is plug the interface into the cassette port of the computer and connect it to an ordinary compact disc player.

It is a strange thing really; I know of very few people who have a C64 and no disc drive but can afford a CD player. Perhaps this package is aimed at someone living at home who can borrow their parents' player.

You can get to grips with this bizarre concept by plugging in the very frail-looking interface. It is not boxed, so dropping the C64 on the floor with it inserted is likely to lead to a fatality.

of your choice loads in 30–50 seconds.

If there are loading difficulties, try the other channel as the programs are recorded on both. If that does not work you can add 20 to the track number – all 10 programs are recorded twice.

If you are thinking I have a disc drive anyway but I have a CD player and this sounds like a cool idea, let me tell you why it is not.

For one thing you are not exactly getting a CD chock-a-block with code. Both blocks of programs

CONTACTS

1st CD Edition
Rainbow Arts
Contact: Barrington Harvey
Price: Circa £29; to be confirmed
Tel: 01-278 0333



ESCROE PLC

11 Mundells Court, Welwyn Garden City, Herts AL7 1EN
Tel: (0707) 334460 Fax: (0707) 331064

LOOK NO FURTHER!!!

DISKS DISKS AND MORE DISKS * TRADE PRICES DIRECT TO THE PUBLIC * COMPLETE WITH USER BETS AND ENVELOPES * LIFETIME GUARANTEE ON CERTIFIED PRODUCT

3 1/2 inch DISKS from 39p*						3inch * PREFORMATTED				
3 1/2inch BULK DISKS						* Certified ERROR FREE				
Quantity	10	500	250	100	50	Quantity	10	500	250	100
DS/DD uncertified	£6.50	.45	.48	.54	.60	* CF7	£17.25	1.30	1.40	1.45
* DS/DD 720K certified	£7.00	.51	.54	.60	.66	* CF2DD	£26.25	2.20	2.30	2.40
* DS/DD 1MB preformatted to 720k	£8.50	.53	.56	.63	.68	AMSOFT CF2	£23.00	1.84	1.94	2.00
* DS/DD 1MB preformatted to 880k	£9.50	.56	.60	.66	.71	MAXWELL CF2	£23.00	1.84	1.94	2.00
* DS/HD 2MB certified	£15.00	1.32	1.38	1.43	1.48	MIMIC CF2	£18.50	1.40	1.50	1.60

5 1/4inch BULK DISKS						VIDEO TAPES - HIGHEST QUALITY				
Quantity	10	500	250	100	50	Quantity	10	500	250	100
* DS/DD 4tpi certified	£3.95	.16	.21	.23	.25	E100	£1.95	1.62	1.72	1.82
* DS/DD 96tpi certified	£4.95	.21	.23	.25	.27	E240	£2.75	2.32	2.42	2.52
* DS/HD 1.6MB certified	£7.50	.52	.55	.60	.63	E180*	£2.35	1.92	2.02	2.22

BRANDED DISKS	
3 1/2" SONY DS/DD 135tpi	£12.99
3 1/2" MIMIC DS/DD 135tpi	£11.50
3 1/4" 3M DS/DD 135tpi	£13.99
3 1/4" MIMIC DS/HD 2MB	£18.00
3 1/2" SONY DS/HD 2MB	£29.99
5 1/4" MIMIC DS/DD 96tpi	£5.95
5 1/4" DYSAN DS/DD 96tpi	£9.99
5 1/4" MIMIC DS/HD 1.6MB	£10.99
5 1/4" 3M DS/HD 1.6MB	£12.99

DISK BOXES	
DP020 20x3"	£8.95
DP040 40x3 1/2"	£4.95
DP080 80x3 1/2"	£6.95
DP050 50x5 1/4"	£4.95
DP100 100x5 1/4"	£6.95
DP140 140x5 1/4"	£7.95

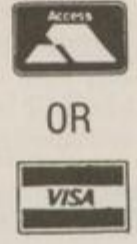

CLEANING KITS FOR ALL DRIVES				
Quantity	1	50	25	10
3"	£ 4.95	3.00	3.50	4.00
3 1/2"	£ 1.99	1.25	1.50	1.75
5 1/4"	£ 1.99	1.25	1.50	1.75
8"	£12.50	8.00	9.00	11.00
Cassette	£ 1.99	1.25	1.50	1.75

New SOFTWARE SECURITY & DUPLICATING SERVICE available now

ORDERS WELCOME FROM GOVERNMENT, LOCAL AUTHORITY, EDUCATIONAL, AND CORPORATES
PRICES INCLUDE POSTAGE, PACKING AND VAT
THESE PRICES ARE FOR PAYMENT WITH ORDER ONLY FOR NEXT DAY DELIVERY
ADD £6 PLEASE MINIMUM ORDER VALUE £30

please send to me

NAME Goods

ADDRESS

Access/Visa No P&P

Signature Total

FUTUREPLACE COMPUTERS



TELEPHONE: 01-692 8700



12 Loampit Hill
Lewisham
London
SE13 7SW

ATARI ST & AMIGA OWNERS WHY PAY TOP PRICES ALL GAMES SOFTWARE AT 30% DISCOUNT

EXAMPLE PRICES	ST
Millenium 2.2	17.50
Robocop	14.00
Silk Worm	14.00
Microprose Soccer	17.50
Kick Off	14.00
Voyager	14.00
3D Pool	14.00
Airborne Ranger	17.50
Falcon	17.50
LED Storm	14.00
Bio Challenge	14.00
Dragon Ninja	17.50

3 1/2" DOUBLE SIDED DISKS
DOUBLE DENSITY
135 TPI GUARANTEED

Quantity	Price
10	£9.50
25	£22.50
50	£43.00
100	£84.00

Please add £1.50 P&P

RRP	OUR PRICE
£12.99	£9.00
£14.99	£10.50
£15.95	£11.00
£16.95	£12.00
£17.95	£12.50
£19.99	£14.00
£22.95	£16.00
£24.95	£17.50
£29.99	£21.00

Atari 520 Power Pack	369.00
Atari 1040 Professional Pack	479.00
Atari Super Pack	349.00
Amiga 500 + Modulator	369.00
Star LC10 Printer	199.00
Star LC Colour Printer	245.00
Citizen 120D Printer Parallel Interface	138.00
Citizen 180E Printer Parallel Interface	159.00

Atari Mouse Extender	5.95
Atari To Scart Lead	14.99
Mouse Mat	4.99
Amiga Second Drive	99.99
Amiga 1 meg Upgrade	139.00
100 Cap Disk Box	9.95
50 Cap Disk Box	7.50

Shop Hours Monday to Friday 10am - 6pm
Saturday 9am - 6pm

CREDIT CARD HOTLINE 01-692 8700

ACCESS VISA DINERS CLUB AMERICAN EXPRESS
Please add £1.50 P&P on all orders under £75. All prices include VAT. CWO to Futureplace Ltd.
Also Available to order MOBILE PHONES and FAX MACHINES

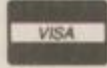

Sir Clive speaks

Sir Clive Sinclair, latter-day computer genius, speaks in a rare interview to *Popular Computing Weekly*. Undeterred by the C5 flop, we find he has plans for two-wheels in his empire. Words by Leslie Bunder, pictures by Steve Coward.

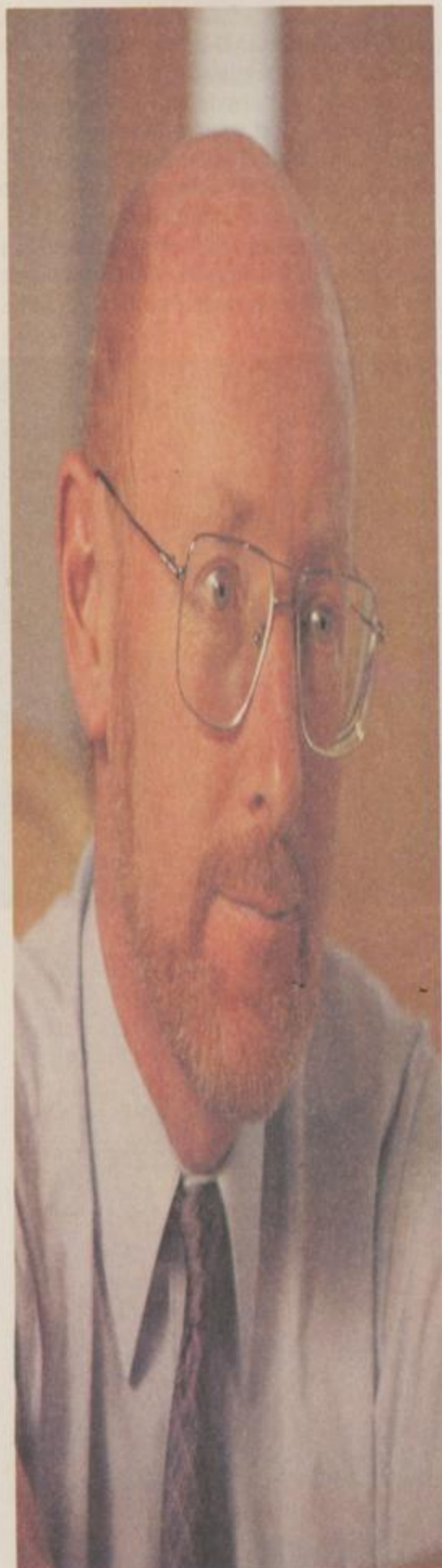

Since forming his first company, Sinclair Radionics, in 1961, Sir Clive Sinclair has probably invented more ground-breaking electronics goods than any other individual. From radios to wristwatches and computers to cars, it can be said that Sir Clive is a man who has been there, seen it and done it. His quest for introducing something new and different often can reach the obsession stage, like his 20-year quest for perfection in producing a pocket television set.

Even now, despite the financial failure of the C5 vehicle and the butt of many jokes, Sir Clive is still working on C10 and C15 vehicles which some day will make it on to the production lines and hopefully on to the roads.

It seems probable that it is this obsession which makes Sir Clive tick. He is a man concerned that his products should reach as many people as possible and be of benefit

"I have a hell of a lot I want to do and I see myself at the beginning rather than the end"

to the whole of society. One has only to look at what Sir Clive has produced and you can see clearly that his products are non-elitist. The calculator, computers and car were all much cheaper than anything else on the market and had mass appeal.

Sir Clive is not a man who copies; he took on the Japanese and Americans at their own game and won. It was because of that and his contribution to society that in 1983, at 33, Clive Marles Sinclair was knighted, due recognition for a man who created a multi-million pound industry and that does not even refer to the hardware.

Without the name Sinclair, the software games giants of Ocean, Mastertronic, Elite would not have enjoyed their massive success. Even the computer publishing industry owes its due to Sir Clive, with three magazines having his name as their title.

With Sir Clive's no-frills approach to computing, he also allowed companies to make such added extras as joysticks,

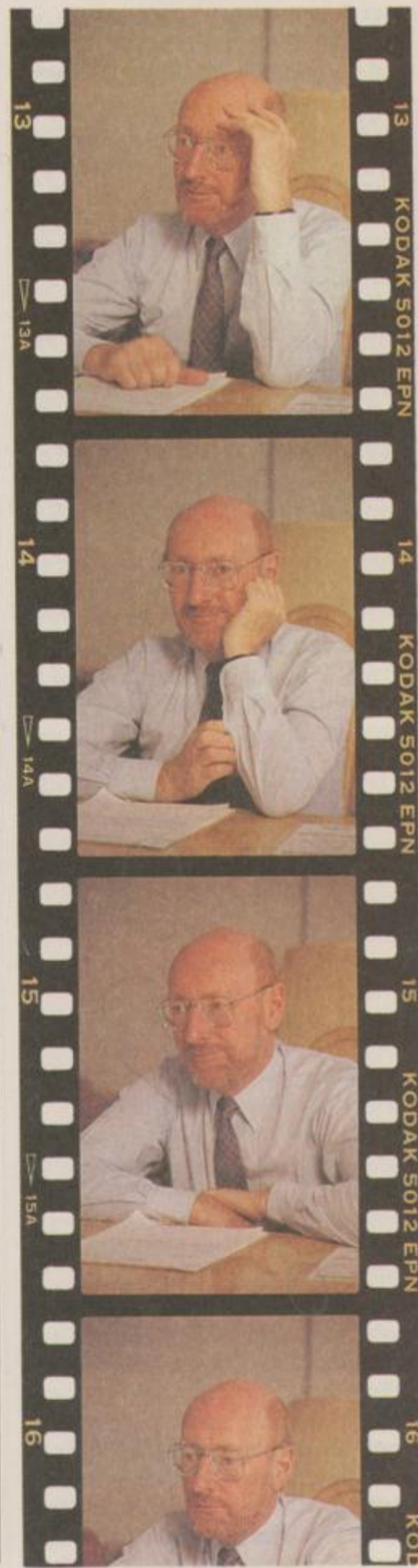

◀ QWERTY keyboards and many other items for his range of machines. In short, he allowed others to create businesses via the products he produced.

Sir Clive is not generally known as a man who seeks publicity. It is several years since he spoke to *Popular Computing Weekly* or anyone else at length, as the following interview will show.

Pop: It is now almost 10 years since the ZX-80 appeared, did you think home computing would be as big as it has become?

Sinclair: Not quite as popular. I certainly hoped it would be a big thing and hoped it

"I am developing this bicycle . . . The purpose is that when you arrive at your flat, office or underground station, you can fold it instantly so that you can take it in – rather like an umbrella"

would be something which captured public imagination. We set out to try to sell to the general public, as opposed to just the enthusiasts around at the time. It grew much bigger than we hoped.

Pop: Of all the computers you have released, which is your favourite?

Sinclair: I think, in a way, the ZX-81 was a good little machine. I am very pleased with the Z-88. I tend always to look forward to the next machine rather than back.

Pop: How is progress on wafer scale integration?

Sinclair: It is coming along well. It will still be a large memory drive and the initial sales will be to the large computer manufacturers. It is still going to plan.

Pop: Can you outline plans for a powerful processing device we gather you are designing?

Sinclair: That work is broadly secret so we cannot say much about it, but it would be foolish to deny it.

Pop: With Atari, Psion and Poquet releasing very lightweight pocket PCs, is this an area into which you have plans to move?

Sinclair: Very much not so. I do not see the logic behind those machines. The concept, or suggestion, is that they are PC-compatible. Well, they are simply not, because it is very important to realise what PC compatibility really means. It means for



Clive Sinclair has revolutionised the world of electronics, from calculators to wrist-watches.

computing. I do not ever play games myself.

Pop: What is happening with the portable telephone?

Sinclair: Sinclair Research formed a company called Shay Communications and the work is now completed. The product is now in production and will soon be on the market and Shay has since teamed with Motorola and Mercury to be one of the licensees for the telepoint system. The telephone should be a personal object like the calculator and will be priced at £150.

Pop: You once had plans for a Stock Market flotation. Do you have plans to pursue this idea again?

Sinclair: We have no plans at the moment. I do not rule it out but it is much more complicated because Sinclair Research has moved its technology out to several companies it founded – Anamartic, Shay, Cambridge Computers – and they might or might not go public and Sinclair Research might or might not go public on its own.



The Z-88 – brought lap-tops to the masses, but Sinclair remains the visionary.

the customer total compatibility; that is to say, it must have a proper keyboard, a proper display and, in my opinion, it must have a drive. If you remove any of those or compromise on any of those the thing ceases to be compatible and you might as well go the whole hog. I cannot see the point of those products. I may be missing something. I do not say they will not sell; no doubt they will in some degree.

Pop: Do you use a Z-88 when you do business?

Sinclair: I do not, but then I do not use computers much anyway. I do not type and do not have a computer at home. I use a pen and calculators.

Pop: With so many games appearing on the Spectrum, do you play any?

Sinclair: No, not at all. We realised people would play games with them; the principal aims behind the machines was to introduce people to the art and science of

Pop: Will 1992 benefit British computer companies and yourself?

Sinclair: Broadly anything which opens the barriers helps but whether the barriers will come down in that area we will have to wait and see. Clearly we still have to do special keyboards for different countries. I do not see that changing. I think it is a

"I think the next generation will have computers in the home which are highly intelligent and start to give advice to people"

"I do not think it is a question of curbing the power of the computer, it is a question of how it uses its power"

psychological benefit but in practice I am not sure there will be a big change. I am concerned about the protectionism that seems to be creeping into Europe. I am worried about Europe setting up tariffs against chips coming into Europe. What I foresee is that companies in Europe might be at a greater commercial disadvantage than companies outside Europe because the Common Market might have insisted on very high prices for memory chips, for example to try and protect the internal



And it's only just begun; Mensa member Sinclair still has a few things up his sleeve.

industry which will mess up the computer manufacturers.

Pop: Do you have plans to move into the development of CD-ROM?

Sinclair: No, I think the application is very limited and they have been over-hyped. It has much to offer games if it is cleverly used.

Pop: Would you ever consider releasing a hand-held games machine?

Sinclair: I am not really so interested in games. I see the appeal but that is not the

field we are in. If we could see a way of doing something dramatic, and we have looked at that in the past, we would do it. We are interested only if we can do something radical in the engineering side. We are interested in technical frontiers and breaking new ground and if that happens to be in the games area, we will do it. The games area does not offer us that opportunity at the moment.

Pop: Have your views on computing changed through the years?

Sinclair: No, I think it is going the way I saw it going. I think we are getting close to the days when students will all be carrying computers because the Z-88 is being used a great deal by students for that purpose. That will change computer literacy greatly. From that will emerge a nation of people who are completely familiar with computers and I think the next generation will have computers in the home which are highly intelligent and start to give advice to people.

Pop: Is it safe for computers to start forming intelligence?

Sinclair: Nothing is without its risks and I think that has plenty of risks but it is a question of getting it right. I do not think it is a question of curbing the power of the computer; it is a question of how it uses its power.

Pop: Do you still have ambitions?

Sinclair: Absolutely, I have a hell of a lot I want to do and I see myself at the beginning rather than the end. There are two areas which concern me most and they are very long term products – artificial intelligence, for which I mean machines which really do rival human beings and electrical vehicles.

Pop: Regarding artificial intelligence, can you put morals into machines?

Sinclair: Whether you call them morals or not, I do not know. I think you need to put constraints into them. It is something necessary that I will do.

Pop: Have you made any decisions not to release any products through fear or worry they are too intelligent?

Sinclair: I have not developed products of that kind but the day may dawn when one will have to look carefully at the consequences of products as they become more powerful. I can certainly see the day when one might regret games machines – when they become so realistic that they seem just as real as life and that people can become addicted to them as they get addicted to drugs; one would be very cautious about introducing such products.

Pop: What motivates you to achieve what you have achieved?

Sinclair: Well, entirely the desire to change the world in a small way, to bring out products which will make peoples' lives more interesting or more useful. The pocket calculator was just a tremendous thing for

people to have; so too the personal computer and I feel passionate about the portable computer. I want to produce new kinds of products which will change peoples' lives for the better. The home computer is a clear example of how it would enrich peoples' lives and now I am developing this bicycle.

Pop: Bicycle, it does not sound very electronic, can you further expand?

Sinclair: The idea is very simple. It is the best way to get around town but a very inconvenient object when you arrive. If you can solve the inconvenience when you arrive, you have a very exciting product, so I'm working on that. It will be a portable bicycle. It will not be electronic and it will be two years before it appears because it is a very big job. To do it you have to use radical materials and have a radical design. The purpose is that when you arrive at your flat, office or underground station you can then fold it instantly so that you can take it in – rather like an umbrella. It must be dramatically lighter than a normal bike – and the lightest bikes have been the same weight for 100 years.

Pop: How do you feel on reflection about your portable TV?

Sinclair: Perfectly sound product. We thought there would be a large market for such a product and so did the Japanese but the world market is still very small.

Pop: Can you give any sneak previews of products you have in mind?

Sinclair: The main thing on which we are working is a PC-compatible portable. It is

"I can certainly see the day when one might regret games machines – when they become so realistic that they seem just as real as life and that people can become addicted to them as they are addicted to drugs"

some way off and not in the same category as the Z-88 and also the very advanced computer chip about which we cannot talk now.

Pop: Aside from Mensa, do you have any other hobbies or interests?

Sinclair: Yes, I am very interested in music, reading, poetry and mathematics. □

LANCASTER

A Lancaster bomber aircraft is shown in flight, viewed from a low angle. The aircraft is dark and silhouetted against a light, hazy sky. The ground below is a flat, open landscape, possibly a field or plain, with some faint lines suggesting a horizon or distant structures. The overall tone is historical and dramatic.

Actual Screenshots

£19.95 AMIGA, ATARI ST

CRL Group PLC, 7D King's Yard, Carpenter Road, London E15 2HD
For more information call 01-985 2391.

IS IT A SIMULATION

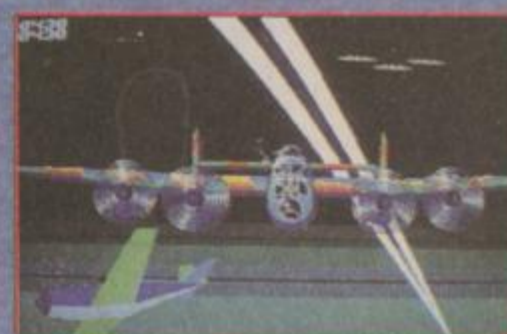

OR IS IT REAL?

Stopwatch

Steve Carter

WHEN developing a program, in most cases speed of operation is a very important factor in its success or otherwise. How do you establish the fastest way of writing a routine you think may be running too slow?

I developed this routine *Stopwatch* to use the internal clock so that I could make

alterations to a program and see the effect on the time it took to run. It is a sub-program so that none of the variables in the routine will clash with the main program when it is tacked on to the end. The two variables which must be placed in the main program have long names so that it is most unlikely that they will clash with any others. To use it, add it to the end of your program and put:

FirstTime%=TIME\$:FirstDate%=DATE\$
at the start of the section you want to time

and:

SecondTime%=TIME\$:Se-
condDate%=DATE\$

at the end, followed by the call to the sub-program.

The program will cope with timing a program over several weeks but if the internal clock should go into the next month your results will be incorrect, so if the timing is to go into the next month, re-set the internal clock to, say, the first of the month.

```

REM -----
REM          DEMONSTRATION OF 'STOPWATCH' TIMING SUB-PROGRAM
REM -----
REM  by STEVE CARTER December 1988
  CLS
  PRINT "DEMONSTRATION OF USING 'STOPWATCH' SUB-PROGRAM"
  PRINT " Time of starting = ";TIME$
  PRINT " PRESS A KEY TO END THE PROGRAM"
Start:
  FirstTime%=TIME$: FirstDate%=DATE$ 'Get the time of start
  WHILE INKEY$="" :WEND              'PUT YOUR PROGRAM HERE
  SecondTime%=TIME$:SecondDate%=DATE$ 'Get the time of finish
  REM   *** call sub-program with arguments of      ***
  REM   *** start time & date and finish time & date ***
  CALL stopwatch(FirstTime$,FirstDate$,SecondTime$,SecondDate$)
END

REM *****

SUB stopwatch(First$,Day1$,Last$,Day2$) STATIC
  REM ***** CONVERT FIRST-TIME TO SECONDS *****
  hrs=VAL(MID$(First$,1,2))
  mins=VAL(MID$(First$,4,2))
  secs=VAL(MID$(First$,7,2))
  firstval=(hrs*3600) + (mins*60) + secs
  REM ***** CONVERT SECOND-TIME TO SECONDS *****
  hrs=VAL(MID$(Last$,1,2))
  mins=VAL(MID$(Last$,4,2))
  secs=VAL(MID$(Last$,7,2))
  secondval=(hrs*3600) + (mins*60) + secs
  REM IF TIMING PASSES MIDNIGHT ADD 24hrs TO SECOND-TIME
  Numdays=VAL(MID$(Day2$,4,2))-VAL(MID$(Day1$,4,2))
  IF Numdays>0 THEN secondval=secondval+Numdays*86400&
  REM DEDUCT FIRST FROM SECOND AND CONVERT BACK
  elapsedtime=secondval-firstval
  hrs = INT(elapsedtime/3600)
  hour$ = STR$(INT(elapsedtime/3600))
  mins = INT(elapsedtime/60)-(hrs*60)
  minute$ = STR$(mins)
  secs = elapsedtime-(INT(elapsedtime/60)*60)
  Second$ = STR$(secs)
  REM          ***** PRINT RESULTS *****
  PRINT " Start time = ";First$
  PRINT " Finish time = ";Last$
  PRINT " Elapsed TIME = ";hour$;" hours. ";
  PRINT minute$;" mins. ";Second$;" seconds."
END SUB

```

520ST-FM SUPER PACK



**1Mb DISK DRIVE
£450 OF SOFTWARE**

ARCADE GAMES		
Arkanoid II	Imagine	£19.95
Beyond The Ice Palace	Elite	£19.95
Black Lamp	Firebird	£19.95
Buggy Boy	Elite	£19.95
Chopper X	Mastertronic	£9.99
Ikari Warriors	Elite	£14.95
Marble Madness	Electronic Arts	£24.95
Quadrillen	Logotron	£19.95
Ranarama	Hewson Consultants	£19.95
Return To Genesis	Firebird	£19.95
Roadwars	Melbourne House	£19.95
Starquake	Mandarin	£19.95
Test Drive	Electronic Arts	£24.95
Thrust	Firebird	£9.95
Thundercats	Elite	£19.95
Wizball	Ocean	£19.95
Xenon	Melbourne House	£19.95
Zynaps	Hewson Consultants	£19.99

SPORTS SIMULATIONS		
Eddie Edwards Super Ski	Elite	£19.95
Seconds Out	Tynesoft	£19.95
Summer Olympiad '88	Tynesoft	£19.95

PRODUCTIVITY SOFTWARE		
Organiser	Triangle Publishing	£49.95

JOYSTICK		
Atari CX40 Joystick	Atari Corp	£4.99

FREE ATARI BUNDLE VALUE: £458.97

The Atari Super Pack is ideal for you if you want to get off to a flying start with the best in entertainment software. The Pack includes a 520ST-FM with 1Mb RAM, a built-in 1Mb disk drive, over £450 of top games and a joystick. If you buy the Super Pack at Silica Shop, we will add our own ST Starter Kit (worth over £200), FREE OF CHARGE. Return the coupon for details.

£399

INCLUDING VAT

With SM124 mono monitor: £498 ^{INC VAT} With SC1224 colour monitor: £698 ^{INC VAT}



ST COMPUTERS

The range of Atari ST computers offers something for everyone. From the games enthusiast who wants the challenge of the very best in arcade action, to the businessman who wants to make financial forecasts or faultless presentations. The ST offers high quality graphics, sound and speed for the gamer, whilst providing a fast, user friendly and affordable solution to business. The ST is now firmly established in the home environment and boasts a wealth of users in education, local government, television, and a variety of different businesses. Software for the range stretches to cover applications as diverse as ENTERTAINMENT, ACCOUNTS, ART, COMMUNICATIONS, COMPUTER AIDED DESIGN, DATABASES, DESKTOP PUBLISHING, EDUCATION, MUSIC, PROGRAMMING, SPREADSHEETS, WORD PROCESSING and more. For a full list of the software available, as well as details of the ST range, complete and return the coupon below.

520ST-FM EXPLORER PACK WITH BUILT-IN 1Mb DISK DRIVE



The value for money offered by the Atari ST range is reflected in the Explorer Pack featuring the 520ST-FM computer with 512K RAM. The 520ST-FM computer now comes with a built-in 1 Mb double sided disk drive as well as a free mouse controller and a built-in TV modulator. The new 520ST-FM Explorer Pack includes the 520ST-FM computer, the arcade game Ranarama, a tutorial program and some useful desktop accessories. In addition, if you buy the Explorer Pack from Silica, we will give you the Silica ST Starter Kit worth over £200, FREE OF CHARGE. Return the coupon for details of our Starter Kit and of the full ST range.

£260

ONLY £2.51 PER WEEK
RETURN COUPON FOR DETAILS
+VAT= £299

+ SM124 mono monitor: £398 ^{INC VAT} + SC1224 colour monitor: £598 ^{INC VAT}

1040ST-FM PROFESSIONAL PACK

NOW WITH TV MODULATOR

For the serious home user and the small business, we are pleased to announce a new package based around the 1040ST-FM. The 1040ST-FM has 1Mbyte RAM and a 1Mbyte built-in disk drive. In addition, the 1040ST-FM now comes with a TV modulator built-in. (The previously available 1040ST-F was designed for use with a monitor only and did not come with a modulator.) This modulator allows the 1040ST-F to be plugged directly into any domestic TV set, and comes complete with a lead to allow you to do so. The new 'Professional Pack' from Silica includes the new 1040ST-FM with modulator plus four high quality software packages including a spreadsheet, database, word processor and programming language. This 'Professional Pack' software will enable you to get straight down to business with your new computer. In addition to this software (worth £384.84), if you buy the Professional Pack from Silica Shop, you will also receive the Silica ST Starter Kit (worth over £200), FREE OF CHARGE. Return the coupon for further information.



£499

INCLUDING VAT

ATARI 1040ST-FM	(Computer)	£499.99
VIP PROFESSIONAL	(Spreadsheet)	£149.95
MICROSOFT WRITE	(Word Processor)	£149.95
SUPERBASE PERSONAL	(Database)	£59.95
BASIC DISK & MANUAL	(Language)	£24.98

NORMAL RRP: £884.82
LESS DISCOUNT: -£385.82
PROFESSIONAL PACK PRICE: £499.00

With SM124 mono monitor: £598 ^{INC VAT}
With SC1224 colour monitor: £798 ^{INC VAT}

2Mb & 4Mb MEGA ST

The MEGA ST computers are styled as a lightweight keyboard with a separate CPU, connected by a coiled telephone style cable. There are two versions of the MEGA ST, one with 2Mbytes of RAM and the other with 4Mbytes. Each version has a 1Mbyte double sided disk drive built-in to the CPU unit. The MEGA STs do not come with modulator built-in and must therefore be used with a monitor. With every MEGA ST purchased, we will add the 'Professional Pack' software (worth £384.83) detailed above, plus the Silica ST Starter Kit (worth over £200) both FREE OF CHARGE. Return the coupon for further details.



2Mb MEGA ST
£899 ^{INC VAT}
+ mono monitor = £998
+ colour monitor = £1198

4Mb MEGA ST
£1199 ^{INC VAT}
+ mono monitor = £1298
+ colour monitor = £1498

DTP PageStream £149 +VAT =£171.35

Desktop Publishing (DTP) is one of the fastest growing applications for personal computers. We are pleased to announce a powerful low cost package for the Atari ST called PageStream. PageStream costs only £149 (+VAT-£171.35) and, because it works with an Atari 1040ST and a Seiko/Sharp SP-180AI printer, you can be up and running with a complete system for less than £1000. Some of the features of PageStream are listed to the right. If you would like further information on this program, complete and return the coupon below, ticking the 'DTP' box in the corner.

- TEXT-FLOW AROUND GRAPHICS
- ROTATION OF TEXT & GRAPHICS
- SLANT OR TWIST ANY OBJECT
- POSTSCRIPT COMPATIBLE
- TAG FUNCTION
- AUTO/MANUAL KERNING & HYPHENATION
- GROUPING OF OBJECTS

DO YOU OWN AN ATARI ST?

If you already own an Atari ST computer and would like to be registered on our mailing list as an ST user, let us know. We will be pleased to send you copies of our price lists and newsletters FREE OF CHARGE as they become available. Complete the coupon and return it to our Sidcup branch and begin experiencing a specialist ST service that is second to none.

SILICA SHOP:

SIDCUP (& Mail Order) 01-309 1111
1-4 The Mews, Hatherley Road, Sidcup, Kent, DA14 4DX
OPEN: MON-SAT 9am - 5.30pm LATE NIGHT: FRIDAY 9am - 7pm

LONDON 01-580 4000
52 Tottenham Court Road, London, W1P 0BA
OPEN: MON-SAT 9.30am - 6.00pm LATE NIGHT: NONE

LONDON 01-829 1234 ext 3914
Selfridges (1st floor), Oxford Street, London, W1A 1AB
OPEN: MON-SAT 9am - 6.00pm LATE NIGHT: THURSDAY 9am - 8pm

WHY SILICA SHOP?

- SILICA STARTER KIT:** Worth over £200, FREE with every Atari ST computer bought from Silica.
- PROFESSIONAL PACK:** Free business software with 1040ST-FM and MEGA ST's bought from Silica.
- DEDICATED SERVICING:** 7 full-time Atari trained staff with years of experience on Atari servicing.
- THE FULL STOCK RANGE:** All of your Atari requirements from one place.
- AFTER SALES SUPPORT:** The staff at Silica are dedicated to help you get the best from your ST.
- FREE CATALOGUES:** Mailed direct to your home as soon as we print them, featuring offers as well as all of the new releases.
- FREE OVERNIGHT DELIVERY:** On all hardware orders shipped within the UK mainland.
- PRICE MATCH PROMISE:** We will match competitors on a 'same product same price' basis.
- FREE TECHNICAL HELPLINE:** Full time team of Atari technical experts always at your service.

FREE SILICA STARTER KIT WORTH OVER £200
WITH EVERY ST - RETURN COUPON FOR DETAILS
ALL PRICES QUOTED INCLUDE FREE UK DELIVERY

To: Silica Shop Ltd, Dept PCW 3.8.89, 1-4 The Mews, Hatherley Road, Sidcup, Kent DA14 4DX.
PLEASE SEND FREE LITERATURE ON THE ATARI ST

Mr/Mrs/Ms: Initials: Surname:

Address:

Postcode:

Do you already own a computer
If so, which one do you own?

DTP

ACE
COMPUTERS

MAIL ORDER
FROM BRISTOL
ADDRESS
ONLY



BRISTOL: 42 Cannon Street, Bedminster Tel: 0272 637981
BRISTOL: 3 North Street Tel: 0272 666341
CARDIFF: 87 City Road Tel: 0222 483069/471600
NEWPORT (Gwent): 54 COMMERCIAL ROAD Tel: 0633 212176
WESTON-S-MARE: 16 WEST STREET Tel: 0934 491040
SWINDON: 31 Faringdon Road Tel: 0793 512073/4

Panasonic Printers

 **KX-P1081**
 • 120 CPS DRAFT
 • 24 CPS NLQ
 • IBM/EPSON COMPATIBLE
 • FRICTION AND TRACTOR FEED
 • CENTRONICS
£129 + VAT = £148.35

 **KX-P1180**
 • 192 CPS DRAFT
 • 38 CPS NLQ
 • 4 BUILT IN FONTS
 • IBM/EPSON
£160 + VAT = £184.00

 **KX-P1124**
 • 24 PIN PRINTER
 • 192 CPS DRAFT
 • 38 NLQ
 • EPSON LQ + IBM EMULATION MODE
£273 + VAT = £314.00

LASER KX-P4450
 • 300 DPI
 • 512 MEMORY
 • SERIAL PAR
 • 1 YEAR ON SITE WARRANTY
£1400 + VAT = £1610

HARD CARDS & HARD DISKS

	EX VAT	INC VAT
21 MBYTE	190	219
32 MBYTE	225	259
42 MBYTE	286	329

ALL HARD DISKS ARE FORMATTED PLUS FREE SOFTWARE

Archimedes



	EX VAT	INC VAT
310 BASE	£759	872.85
MONO	£799	918.85
COLOUR	£949	1091.35

PC EMULATOR ... £68 78.20

	EX VAT	INC VAT
410 BASE ..	£2147	2469.00
MONO	£2187	2515.00
COLOUR	£2300	2645.00

NEC MULTISYNC MONITORS

GRAY	£160	184.00
COLOUR MUF TI II	£460	529.00

CITIZEN 1 2 0 D

★ 120 CPS DRAFT
 ★ 24 CPS NLQ
 ★ FRICTION AND TRACTOR FEED
 ★ 4K BUFFER
£120 + VAT = £138
 HQ-P45 24 PIN WIDE CARRIAGE
£340 + VAT = £391

EPSON PRINTERS

LX800
£160 + VAT = £184

LQ5000
£280 + VAT = £322

MANNESMANN TALLY
 The NEW
 • DRAFT 130 CPS £120 + VAT
 • NLQ 24 CPS + VAT
 • CENTRONICS = £138

ATARI

★ 520 STFM incl 22 SOFTWARE PACK
£310 + VAT = £356.50

★ 1040 STFM
£340 + VAT = £391

AMIGA 2000

★ 20 MBYT HARD DISK
 ★ 5.25" DISK DRIVE
 ★ 3.25" DISK DRIVE
 ★ XT BRITDGE BOAR
 ★ 1084 OR 8833 COLOUR MONITOR
£1380 + VAT = £1587

AMS ADVANCE BUSINESS CENTRE

DAISY WHEELS TRIUMPH ADLER

★ 20 CPS
 ★ ADVANCE PAPER HANDLING
 ★ A3 SIZE
£199 + VAT = £228.85

DAISY WHEELS

JUKI 6000
 (Serial only)
£120 + VAT = £138

AMIGA 500

MOUSE, JOYSTICK + 23 PUBLIC DOMIN SOFTWARE
 • ZYNAPS
 • MERCENARY
 • BACKLASH
 • QUADRALIEN
 • NO EXCUSES
 • POWER PLAY
£340 + VAT = £391

SERVICING

WE REPAIR MOST KINDS OF COMPUTERS AND PRINTERS.
 FOR BUSINESS WE CAN GIVE 24 HOURS ON SITE WARRANTY.
 PLEASE PHONE FOR DETAILS

star Printers

LC-10 & LC-10c
 • 6 BUILT IN FONTS EXVAT INCLVAT
 • 120 CPS
 • 30 CPS NLQ **£150 172.50**
 • 4K BUFFER

LC-10 COLOUR
 • FULL COLOUR PRINTER
 • PLUS ALL THE ABOVE FACILITY
£190 218.50

LC-24
 • EXCELLENT 24 PIN
 • NLQ-BUILT IN FONTS **£276 317.40**

NB24
 • INCL FREE CP **£420 483.00**

NX-15
 • WIDE CARRIAGE **£286 328.90**

NB24-15
 • 24 PIN W/DE/C **£550 623.50**

PHILIPS MONITORS

	EX VAT	INC VAT
MONO 7502	£68	78.20
COLOUR 8833	£217	249.65
COLOUR 8852	£260	299.00

IF YOU LIKE TO RUN YOUR OWN FRANCHISE

PLEASE WRITE TO:
STEVE MORRISON
47 CANNON STREET,
BEDMINSTER, BRISTOL
BS3 1BN

OPENING END OF AUGUST HASTINGS • COVENTRY • NOTTINGHAM



Software Development Ltd.

TEQUE

Teque is one of the leading Software Development Houses in the U.K. We are creators of hit games such as Pac-mania, Xybots, Blasteroids, Prison, Terramex and Thunderbirds.

We are currently working on Toobin, Continental Circus, Passing Shot, Scramble Spirit, Chase HQ, Laser Squad and Manchester United F.C.

We are looking for talented **Programmers** and **Graphic Artists** to work on 8, 16 and 32 bit home computers and consoles.

We offer an extensive package to the right people.

**For further details please contact Tony Kavanagh on
Rotherham (0709) 370102 or send full C.V. to:-
Teque Software Development Ltd, Teque House, Masons Yard,
Downs Row, Moorgate, Rotherham, South Yorkshire S60 2HD.**

IT'S TRUE!*

star LC-10 £159.95

star LC-10 £209.95
COLOUR

INCLUDING VAT & FREE LEAD
ALL UK VERSIONS
BRAND NEW
4 YEAR WARRANTY



HURRY LIMITED STOCK

* BUT ONLY FROM:

(ST, AMIGA, PCE,
AMSTRAD PC)
**ORIGINAL STAR
ACCESSORIES**

LOW PRICES
(If purchased with Printer)
CUT SHEET FEEDER
£59.99
BLACK RIBBON
£3.99
COLOUR RIBBON
£5.99

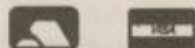

EALING COMPUTER CENTRE

19, Queen's Parade, London. W5 3HU
Tel: 01 991 0928

For Next Day Courier Add £6 (within M25) or £10 Mainland
Access and Visa - All offers subject to availability - E. & O.E.

IT'S TRUE!*

MONITOR SM124
MONO FOR ATARI ST
ONLY £99.95

INCLUDING VAT, ALL CABLES AND FREE
ANTISTATIC, FLAME-RETARDANT DUST
COVER WORTH £6.99

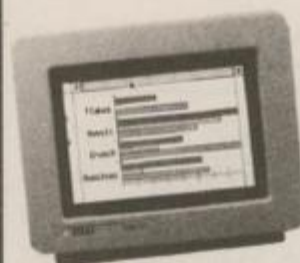

SAVE YOUR EYES!

It costs only 28p per day for a year.
This is one and only mono monitor to
use with Atari ST. 12" diagonal, paper
white with antiglare treatment, high
resolution 640 x 400 pixels, 80 column,
flicker-free.

Matching dust cover for 520STFM/1040STF/1040STFM

ONLY £4.99

HURRY LIMITED STOCK

*BUT ONLY FROM:

EALING COMPUTER CENTRE

19, Queen's Parade, London. W5 3HU
Tel: 01 991 0928

For Next Day Courier Add £6 (within M25) or £10 Mainland Access and
Visa. All offers subject to availability - E. & O.E.

Seal'n Type™

Type-through keyboard cover

Protect against dust, spills, ash & grime. Removable, Washable, Re-usable

Can be custom-made for any keyboard. Ring for details.

£10.95

Unique and ingenious Spill Cover

FAT PENO
NIC DESIGN

RING OR WRITE FOR OUR FREE CATALOGUE

- A Universal keyboard feet.....£4.95
- B Data Switch box.....£26.95
- C Mouse Pad.....£5.95
- D Peace 'n' Quiet Acoustic Box/Printer with optional stand (Also available for other models)..... from £38.95
- E Paper Tray PCWB.....£8.50
- F Plonker box working disc holder.....£3.50
- G Cheerup Mug.....£3.75
- H Disc Storage Holder.....£5.50
- I Screen in View VDU Filter.....£16.00
- J Densite Copy Holder A4.....£8.50
A3.....£10.00



RE-INKING SERVICE PRICES ARE FULLY INCLUSIVE

★ All types of fabric ribbons

eg £1.90
Amstrad+Epson

- ★ Re-inked like new
- ★ Same day service
- ★ Free transporter SAE
- ★ For all types of fabric ribbon

Ring us!

Trade Enquiries welcome

Cheques/PO payable to: Kador
KADOR, Unit 4
Pontcynon Ind. Est.
Abercynon, Mid Glam.
CF45 4EP

Tel:
0443
740281

FREE RE-INK WITH
ORDERS OVER £5.00

kador

16/32 P.D.

PUBLIC DOMAIN FOR THE ST

Large Selection

Prices start from £1.00

Send A4 SAE with 25p stamp for catalogue or £1.25 for catalogue DISK with extra goodies to:

**35 Northcote Road, Strood
Kent ME2 2DH
Tel. 0634 710 788**

Q U A N T A

QL Users And Tinkerers Association* Independent QL/Thor Users Group
*Worldwide Membership *Sub Groups *Advice *Back-Up *Monthly Newsletter*
Extensive Software Library of (mostly FREE) Programs

MODEMS

For a limited period QUANTA is offering TANDATA modems at special rates to members. If you aren't a member, why not join? It's still cheaper than any other modem! Membership is £14 per year UK, £17 overseas.

QMOD + QCONNECT for only £20

QMOD + QCONNECT + QCALL £25

Please add £2.50 post & packing

No, these are not misprints. As a further bonus we are shipping these modems with the excellent QuaLsoft software courtesy of TF Services.

QUANTA, Dept PCW, 15 Grosvenor Crescent, Grimsby, South Humberside DN32 0QJ.
Tel: 0472 49850.

POSSIBLY THE LARGEST AND CHEAPEST COMPUTER COMPANY IN LONDON?

From Amstrad to Zenith we stock the lot.

For example

Amstrad
Commodore
Samsung
Tandon
Apricot
Olivetti

Philips
Barbaton
Osicom
Epson
Wyse
Zenith

And many, many more

Also rate discounts on all new Amstrad 1640 and 2086, Commodore PC40 bundles, Hard Disk, Hard Cards and a full range of Printers, Software and Peripherals.

For the largest discounts available call
**NORTH CIRCULAR
TECHNOLOGIES (UK) LTD**
on 01-881 0685 Fax: 01-889 6002
or call in and see us at
268 Boundary Road, Woodgreen,
London N22 6AJ

Save money now, not when it's too late

Mention

TECHNICAL SERVICES

Telephone/Fax: 0436 78827

MAIL ORDER ONLY PC ENGINE WITH PAL TV CONVERTER AND BOOSTER!

With a One Year Guarantee
ONLY £159.95! (+ £5.00 P&P)

NEW TITLES NOW IN STOCK

Power Golf.....£29.95 (£1.50 P&P)	Pacland.....£29.95 (£1.50 P&P)
Naxat Open.....£29.95 (£1.50 P&P)	Fire Pro Wrestling.....£29.95 (£1.50 P&P)
Cyber Cross.....£29.95 (£1.50 P&P)	Ninja Warriors.....£29.95 (£1.50 P&P)
Gun Head.....£29.95 (£1.50 P&P)	Side Arms.....£29.95 (£1.50 P&P)
Final Lap Twin.....£29.95 (£1.50 P&P)	Japan Warrior.....£29.95 (£1.50 P&P)

**VHS VIDEO
ACTION
FROM
PC
ENGINE
GAMES
ONLY
£6.95
(+£2.00)**

PC ENGINE
SUPER JOYSTICK
WITH AUTOFIRE
AND SLOMO
ONLY £24.95 (+£2.00 P&P)
5 PLAYER ADAPTER
£19.95 (+£2.00 P&P)
48 PC ENGINES
SOFTWARE
TITLES IN STOCK.
A LARGE S.A.E.
FOR FULL DETAILS

16 BIT SEGA
MEGADRIVE (SCART)
ONLY £179.95
(+£5.00 P&P)
8 Titles in stock
SUPER LEAGUE
£29.95
(+£1.50 P&P)
**SUPER MILITARY
COMMANDER**
£29.95 (£1.50 P&P)

CD ROM Drive &
Interface Unit.....
£299.95 (+£5.00 P&P)
Fighting Street
.....£31.95 (+£1.50 P&P)
Wonderboy 2
.....£31.95 (+£1.50 P&P)
Warriors 2
.....£31.95 (+£1.50 P&P)
Ultraspace Story
.....£31.95 (+£1.50 P&P)

Cheques and Postal Orders/Large S.A.E. for details to:

MENTION TECHNICAL SERVICES
Dept C.E. PO Box 18, Helensburgh G84 7DQ
Monday - Friday 9am - 5pm. Mail Order Only

Mention Bank with The Royal Bank of Scotland,
2 Colquhoun Square, Helensburgh, G84 8SJ
Please allow 28 days for delivery
Europe orders please add £3.00 per ITEM FOR POSTAGE.

29 Malcolm Place, Helensburgh G84 9HW

COMMS PLUS!

COMMS PLUS! is a new bi-monthly magazine for the Sysops and Users of the growing number of Bulletin Boards and Online Services in the UK.

In each issue we will be covering COMMS NEWS, VIEWS, and PERSONALITIES - alongside MULTI USER GAMES and SF & FANTASY.

Our pilot issue goes onsale (by mail order) on OCTOBER 1st. For your copy, just send a cheque made out to COMMS PLUS! for one pound (or six pounds for a year's subscription) - along with your address - to: COMMS PLUS!

3 BRIDGE TERRACE
BRIDGE STREET
MORLEY
LEEDS LS27 OEW.

**BRINGING TOGETHER
THE ONLINE COMMUNITY.**

Gilroy Consultants Ltd

20 Fairways, Isleworth, Middlesex
TW7 4LB

Tel 01-568 9183; 01-580 7366 FAX: 01-568 8357

PROFESSIONAL SOFTWARE

Hospitality - Hotel Administration and
Reservation System

Bookings, Reservations, Sales, etc

£650

ChiWriter - Scientific and Linguistic Word
Processor

Standard Version, European Languages and Maths Symbols

£150

De Luxe Version, as above plus Russian and Chemistry Symbols

£230

Video 1 - Video Club Administration System

Daily Transactions, Reservations, Stock and Customer Control,
Screen Enquiries, Print Reports

£100

Esti2 - Invoicing and Estimating System for the
Printing Trade

Customer File, Calculations based on Stock and Action Codes
held on disk

£120

QFile Utility - Selective Copying and deletion of
files held in various directories

£45

Prices are exclusive of VAT, but do not include P&P. User
Guides supplied with software and training given if required at
moderate charges

Terms: Postal Order/Cheque with order

EXCITING DEALS IN ENTERTAINMENT SOFTWARE

- Hire software for less than 25% of RRP
- Purchase titles at Rock-Bottom prices
- Try Before You Buy at no extra charge
- Fantastic free gift opportunities

Write now for more details (stating computer) to:

CJC Marketing (Dept PCW1) • Unit 9 • The Maltings
High Street • Burwell • Cambridge • CB50HB

Tel: (0638) 742494

JJAC SOFTWARE

We are a recently established software company currently looking for new commercial quality products to publish, both on 8 and 16-bit formats

So, if you have written or are developing software of a standard you feel is suitable for release then contact Jonathan Clarke on 01-994 4289

Or send samples of your work to:

JJAC Software
169 Chiswick Village
London W4 3DG.

MICRO-TECH COMPUTER TECHNOLOGY

19 NORTH AVE, EASTBOURNE, SUSSEX
TEL: 0323 411391

COMPUTERS BOUGHT, SOLD
AND EXCHANGED

PC's, XT's, AT's, 286's and 386's SOLD
NETWORK SYSTEMS INSTALLED

J.D. LEWIS COMPUTERS AND REPAIR SERVICE ● MAIL ORDER ONLY ●

5 1/4" DSDD 96tpi Unbranded.....	£3.95
5 1/4" DSDD 48tpi KAO.....	£8.95
3 1/2" DSDD KAO.....	£16.95
3 1/2" DSDD Kodak.....	£15.45
3 1/2" DSDD KAO Bulk.....	£9.45

All disks supplied in 10s

ST Joystick/Mouse Extensions.....	£4.95
Mouse Mats (Red or Blue) Soft Type.....	£3.75
Amiga/ST Printer Leads 2m.....	£7.50
Spectrum + 3 Cassette Leads.....	£3.45
Disk Cleaners 5 1/4" or 3 1/2".....	£3.50
5 1/4" Storage Box 140 Capacity.....	£8.95
3 1/2" Storage Box 80 Capacity.....	£7.95

All items subject to availability. P&P FREE on all orders over £10.00. Otherwise add 65p. Software available with up to 20% Discount. Look out for our advertisement in issue 32. FULL CATALOGUE IS NOW AVAILABLE. Send large SAE for your copy.

Make Cheques and P.O.'s payable to: J. D. LEWIS, 97 Chaplin Road, Longton
Stoke on Trent, Staffs ST3 4RH. Telephone: 0782 323348.

ATARI XL/XE

Ace of Aces.....C	£2.95
Crackup.....	£1.95
Dawn Raider.....C	£1.95
Draconus.....C	£8.95
.....D	£11.95
Encounter.....C	£2.95
Euro Super Soccer.....C	£8.95
.....D	£12.95
F-15 Strike Eagle.....C	£8.95
.....D	£12.95
Kennedy Approach.....C	£8.95
.....D	£12.95
Quartet Gold.....C	£3.95
River Raid.....R	£9.95
Speed Ace.....C	£2.95
Superman.....C	£2.95
Zybox.....C	£2.95

STAR WARS C £9.95 D £11.95
KENNY DALGLISH £8.95
SPEED RUN C £6.95 D £8.95

SUNARO

FREEPOST, PO BOX 78 MACCLESFIELD, (POP)
CHESHIRE SK10 3YB
TELEPHONE (0625) 25228

Please add 55p handling charge to all orders. UK & Overseas P.O.'s payable to SUNARO SOFTWARE



S.F.A. COMPUTERS

NOW AVAILABLE! THE CLIPPER AT. PC KIT

Everything you need to build a Powerful AT style Computer in one package including full instructions and step by step video.

Kit comes with Motherboard, 200W Power Supply, AT Case, 1.2MB Floppy Drive, Floppy Controller, Videocard, Serial + Parallel Ports + Games Port, Samson C Monitor, 512K RAM, 102 Key Keyboard, MSDOS 3.3, Phoenix Bios + All Manuals

PRICES

80286/7.5MHz £675 + VAT • 80286/12MHz £749 + VAT
80386/20MHz £1,195 + VAT

A special Preview Video is available for just £2.95
All enquiries to:

S.F.A. COMPUTERS

UNIT 15, ABBEY MILL BUSINESS CENTRE,
PAISLEY, SCOTLAND PA1 1JN

Telephone: 041 840 1477



Z88 and PSION ORGANISER from TK COMPUTERWARE

The Mail Order Specialists
Z88

Z88 Computer.....	£227	Centronics Interface.....	£30
Carry Case.....	£10	Mains Adaptor.....	£10
PL 2 Link.....	£35	128K Eprom Pack.....	£50
32K Ram Pack.....	£20	Z88 Computing.....	£10
128K Ram Pack.....	£50	Using Your Z88.....	£10
512K Ram Pack.....	£200	Spell Master.....	£59
Z88 Reference Manual.....	£16	Disk Drive.....	£275

WORD MONGERS SOFTWARE

Z Base-Z-88 Off Base Data Base for Z88

Designed for both first-time users and experienced 'd' Base Programmers. Z Base with its front end provides full relational database facilities from the Z88

£269

Z-Base-Z88 Terminal Package

Scrolling and View Data Modes, compatible with Haynes, Miracle and Dumb Modems, Auto Dial with programmable function key

£52

Z Tape-Z88 Cassette Interface

Integrated Package of Software and Cabling to use cassette recorder as file storage for Z88. Includes catalogue tape, save, fetch and verify, also option to run machine program from RAM. Z Tape menu follows pattern of []f, filler

£52.50

PSION ORGANISER

Organiser LZ64.....	£180	Spread Sheet.....	£40
Comms Link.....	£60	Spell Checker.....	£30
32K Data Pack.....	£35	Data Organiser.....	£35
64K Data Pack.....	£60	Finger Organiser.....	£35
128K Data Pack.....	£100	Organiser Box.....	£10
32K Dram.....	£55	Psion Printer.....	£195

For further details contact: TK COMPUTERWARE

Stone Street, North Stanford, Ashford, Kent TN25 6DF

Tel: 0303 812801; Int: 010 44303 812801; Fax: 0303 812892 Telex: 96676 PMFAB G

ALL PRICES INCLUDE VAT AND UK MAINLAND DELIVERY

A day at the Beeb

Duncan Evans joins the resilient species of micro owners at Ally Pally for the BBC Show.

If owners start to look like their dogs there is a good case for computer users adopting the traits of their machines. At the BBC Show at Alexandra Palace that was very evident. Overbearing fathers and confused mothers led anorak-type BBC B/Master-owning teenagers round the thinly-attended stalls; packs of Archimedes owners, looking for a spreadsheet package to work out when they would pay off the loan they took to buy the machine were everywhere.

The BBC may be outdated and dead so far as mainstream computing goes but that never seems to worry Mum and Dad as they avoid admitting that the machine they bought to educate Johnny was used only for playing *Ballistix* by trying to find the Clares Micro stand.

So far as this show was concerned the BBC was not dead but with only Watford Computer Concepts and Superior showed any real commitment. There were not many nails left to bang into the coffin. It was the day of Archimedes but not in a manner likely to launch it into the computing mainstream.

First let us see what was on offer for the BBC. Wight Scientific - 01-858 2699 - was getting excited about *Signwriter* and its very impressive

range of fonts for producing display lettering for £29.95 - and £49.95 on the Archimedes. Topologika, famed for re-issued and new adventures, has gone green with a range of booklets, tapes, records and, of course, computer programs dedicated to whales, with assistance from a member of Friends of the Earth; you should telephone Topologika on 0733 244682 for details if you want your children to know about the greatest of mammals.

Substantial

More labelling software, this time from Mewsoft - 01-267 2642 - entitled *The Fancy Labeller* and retailing at £12.95 for the BBC B and Master 128 and £27.90 on the Archimedes. If you fancy something a little more substantial you could try the Permanent Memory Systems - 03552 32796 - *The Publisher*, which claims to be a no-nonsense DTP package for the entire BBC range at £39

plus VAT and £1 carriage. Compatible with *View*, *Inter-Word* and *Wordwise*, it offers 86 fonts. PMS was also selling its last few Genie and Genie Junior Personal Organiser ROMs.

Topical

Perhaps the biggest splash for BBC owners was made by Impact Software - 0898 654334. Impact showed extra courses for its *Leaderboard* clone, *Holed Out* - topical because Mark Calcavecchia won the Open Championship in the same week - and also a new football game.



Remembered as an educational micro, BBC users can still enjoy some impressive software.

Arcade Soccer is a *Microprose Soccer/Kick Off* derivative featuring overhead action and a World Cup in which to compete.

Superior Software has the licence to the *Psygnosis Ballistix* and is threatening its own version of *Kick Off*, which should be available as soon as programming is finished.

Back to the real world with *Click*, a Master cartridge from Slogger Computers - 0272 743683 - enabling the user to use memo, snapshot, xtree, utilities and restore functions.

Possibly the most exciting aspect of the show were the genlock and real-time digitisers for the Archimedes. *Wild Vision* - 091 2818481 - had a large section of hardware items for the Archimedes, including the Chrom 300 series of video overlay and genlock cards. One of the most impressive things at the show was the Hawk V9 real-time colour digitiser. Images are displayed in any Archimedes 256-colour mode, with the

image resolution being 256x512. Availability is late 1989 and pricing is expected to be less than £500.

Something of a challenge was offered by the Arvis Videographics Expansion Card ARDG.2 which offers real-time colour digitising, grabbing frames at 1/50th of a second and using its own display system to produce 3,200 colours for the finished image which can be used with most art packages. Contact Video Electronics Ltd on 0942 882332 for details.

To augment the power of the Archimedes you could always buy most of the things in the Oak

Computers - 0532 502615 - catalogue. Internal hard drives from £299 (20MB) to £555 (40MB, 28ms) and externals from £349 (20MB) to £795 (64MB). If you want to use those hi-res modes you need a multi-sync monitor - £1,495 for a 20in. screen; then you can play *Worra Battle*, in other words *Battlezone*, for only £14.95.

For word processing with extra activities like database search, data entry and spreadsheet generation, *Premier* from Circle Software sounds a good choice. The price is £96 plus VAT. Contact 0793 770021. Or you might like to try *Impression*

from Computer Concepts. It is powerful yet easy to use, drawing on Concepts experience of producing word processors for the BBC.

Average

Archimedes games are a little light relief - a joke some might say - but there seem to be a few of them around, mostly average renditions of classic arcade games. Considering that the Archimedes can emulate current arcade games *Thundermonk*, *Hoverbod*, *Orion* - *Defender* - *Missile Control* and *Ibix the Viking* are not exactly stunning. They are reasonably priced, though, at £14.95 for all except *Ibix*, which is £19.95.

Clares Micro, beside the usual educational products, was hinting at an *Interceptor*-style game called *Interdictor* (£34.95) and selling some poor ones like *Overload*, *Mazey Man* (Pacman) and *Bounce a Ball* (Breakout).

Software

SUPERSTORE

YOUR ONE STOP SHOP

MORE SOFTWARE THAN YOU CAN HANDLE!
MORE HARDWARE THAN YOU CAN USE!

AMIGA A500

inc. FREE Modulator

PLUS:-WORKBENCH 1.3 AMIGA EXTRAS 1.3
AMIGA BASIC 1.2 AMIGA "THE VERY FIRST"
MOUSE CONTROLLER AMEGAS ART OF
CHESS BUGGY BOY WIZBALL TERROR
PODS INSANITY FLIGHT IKARI WARRIORS
BARBARIAN THUNDERCATS MERCENARY
COMPENDIUM INDIVIDUALLY WORTH £643.49

ONLY £399.00 OR £17* MONTHLY

Philips 8833
Colour Monitor with
Stereo Sound &
High Resolution
Only **£269.00**

*Subject to Status



FREE
Paint Program
(Photon Paint or Sprite)
when you buy an
AMIGA 2nd Drive with
switch & through-port
OUR PRICE
ONLY £99.99

STAR LC10
PRINTER + FREE CABLE
SUPERB VALUE
ONLY £219.99

Commodore 1230 Printer. (NLQ)
Centronics & C64 Interface as standard
inc FREE cable **ONLY £169.99**

OCEANIC DISK DRIVE

C64 Compatible

Plus FREE

First World
Logo
intro to Basic II
Spirit of the Stones
Assembler/Monitor 64
Programmers Utilities
Zork III
Dragonworld

ONLY £129

WHY PAY MORE?

We may not be the very cheapest.
But when it is down to service,
selection and advice...

**WE CAN'T BE
BEATEN**

Visit us soon and find out why so
many wouldn't go elsewhere

**MAIL ORDER:-
ADVICE HOTLINE
(0782) 268620**

for FAST & FRIENDLY SERVICE

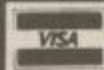

SEND S.A.E. FOR CATALOGUE

STOKE-ON-TRENT

11 Market Square Arcade - Hanley
Stoke on Trent
Manager: Dave - Tel: 0782 268520
Open 6 Days

SHEFFIELD

6 Wingate - Sheffield
Manager: Tony
Tel: 0742 721906
Closed Thursday

ST HELENS

27 Baldwin Street - St Helens
Manager: Adrian
Tel: 0744 27941
Closed Thursday

STOCKPORT

6 Mealhouse Brow
(Off Little Underbank) - Stockport
Manager: Ray
Tel: 061 480 2693
Closed Thursday



DOMARK

*Do you want to join the team
behind this year's top Tengen
coin-op conversion?*

*Do you want to join the team
behind this year's top movie
licences?*

Domark is looking for a
**SOFTWARE
MANAGER**

to make next year our
biggest yet.

*Your duties will include running the
programming teams from conception
to finish. You'll need initiative, self-
motivation, an ability to think on
your feet, to be fully computer
literate and experience of project
management.*

**Salary negotiable. Use of a
company car.**

Please send your c.v. to:

**Lizzie Wright,
Domark Limited,
Ferry House,
51 - 57 Lacy Road,
Putney, London SW15 1PR.**

WHO SAID WE WERE JUST ANOTHER BOOK CLUB!

No other book club will offer you more and demand less.

In fact if you buy computer manuals of any sort then you won't get better value than up to 50% off publishers prices. You need only commit to 3 titles (excluding special offers) in your first year which could mean as little as £15.

WE OFFER

- FREE Membership
- FREE quarterly full colour catalogue
- EVERY title reviewed and pictured
- OVER 160 titles to choose from (and increasing)
- TITLES from £5 to £50
- TITLES for Amiga, Atari, IBM Compatibles, PC's, Apple Macintosh
- CATALOGUE now includes Training Software and Computer Supplies

WE WILL (After your first year)

- Cancel your membership immediately when requested
- Automatically cancel your membership (with your agreement) if you do not purchase anything in a six month period.

WE DO NOT

- Send you anything you haven't ordered
- Pass on your name and address to anyone

SO JOIN TODAY!

Take advantage of our excellent value introductory offers now by filling in the coupon and returning it to us for immediate despatch of your chosen titles and our NEW catalogue PLUS your mystery FREE GIFT.

Hurry while stocks last of our unbeatable special introductory titles! (We reserve the right to substitute a suitable alternative)

CHOOSE UP TO 3 TITLES
FROM **£1** EACH PLUS P&P
(while stocks last)

FREE GIFT WITH YOUR FIRST ORDER



Please accept my application to join the CUBCLUB. I understand that the minimum membership is 1 year, and I agree to take at least 3 titles (not including special offers) in my first year. I understand that my membership will be renewed automatically although I am under no obligation to take any titles after the first year. I understand that if I do not take any titles within 6 months of the second year my new membership will be cancelled.

Please send me the introductory titles whose nos are listed below:

I understand that I will be charged the special offer prices shown plus a maximum postage and package charge of 75p per book (initial order). I am over 18 years of age (if you are under 18 membership must be in the name of your parent or guardian. Please ask their permission). Overseas send for details or payment with order.

**COMPUTER
USERS
BOOK
CLUB**

7 Blaina Centre, Rising Sun Ind. Estate,
Blaina, Gwent NP3 3JW (0495) 292169

MR/MRS/MISS/MS _____

ADDRESS _____

POSTCODE _____

TYPE OF COMPUTER _____

SIGNATURE _____

Spectrum, Amstrad, Commodore REPAIRS

Prompt, professional and personal service
by qualified repairs
(FREE ESTIMATES)

AVC CARE OF ORTEC
GEC Switchgear Dep (Pop)
Melba Street, Manchester M11 1FL
Tel 061-301 2210

CAPITAL COMPUTERS EDINBURGH
Tel: 031-228 4410



Tired of the large,
impersonal high
street stores?

Yes? Then try us!
**GLASGOW COMPUTER
CENTRE** Tel. 041-332 8246



WOULD YOU LIKE A PORSCHE?

THIS IS NOT A DREAM! YOU CAN EARN
BIG MONEY WITH YOUR MICRO!
SEND A S.A.E. FOR FREE DETAILS.
YOU WILL NOT BE DISAPPOINTED!
M.B.C., 22 Beacons View Road, Clase,
Swansea, South Glam. SA6 7HJ.

PCW 9512 USERS

Answer this add to discover how to pay
ONLY £2 each for top quality
CARBON FILM RIBBONS for your printer.
Send SAE to:
ALADDINK (CF/PC)
EYEMOUTH, BERWICKS TD14 5AP
Telephone: 08907 50965

MID SUTHERLAND DATA

PC ATARI AMIGA SOFTWARE
QUALITY DISKETTES
PHONE NOW FOR DETAILS
0862 3728

3.5in Coloured Disk Labels

£2.50 per 100
2.75in x 1.48in Continuous White Labels
£3.99 per 500
Includes VAT, P&P. Many other items in stock
Exmouth Micros, 13/15 South Street,
Exmouth, Devon EX8 2SX
Tel 0395 267734. FAX: 0395 272683

E.M.P.D.L.

Amiga Public Domain Library
Open 7 Days - 9am to 9pm
Immediate Despatch on all orders
£5 per year subscription includes 3 Catalogue
Disks (regularly updated FREE). Range of
accessories etc. Write now for details.
Cheques & POs payable to:
E.M.P.D.L. 54 WATNALL ROAD
HUCKNELL, NOTTS. Tel: 0602 630071

£8.00 FOR 10 DS/DD 3.5 DISKS

DS/DD Unbranded (Verbatim manufactured)
£8.00 per ten inc VAT, P&P. Full lifetime warranty.
Same day despatch. Guaranteed cheques/POs.
Best prices coming soon on Verbatim branded disks.
Send s.a.e. for prices.
Please note we have changed our name.
JOY OF LIFE ARTS
45 Elswick, Skelmersdale, Lancs. WN8 6BX
Tel: 0695 24732

PLAY WITH ME - ADULTS ONLY.
Dial 0898 442 887 now!! (25p/38p per
min) ... we dare you to listen.

To advertise in the
classified section
phone 01-834 1717
NOW

Hobbyte

COMPUTING

INCORPORATING

BuSyste

BUSINESS COMPUTING SERVICES

AMIGA ACCESSORIES

BBC EMULATOR	£39.95
C64 EMULATOR	£69.95
A500 MODULATOR	£23.95
MINIGEN	£99.95
DIGITISING PACK with Camera, Digiview Gold 3.0, cables	£329.95
PRO SOUND DESIGNER GOLD	£69.95
MIDI INTERFACE MM 3000	£24.95
CASIO MT 240 KEYBOARD	£119.95
MODEM PACK, AD/AA HAYES V21/23	£249.99
Inc. Ruby Prestel/Turm Em S/W, cables	Price inc. VAT.

DISCOUNTS FOR EVERYONE

Hobbyte Business Computer Services, is proud to announce that from June 22, our trade special discounts will be available to YOU THE GENERAL PUBLIC
Phone us.

ASMIGA 2000, Mouse, Wkbench, Basic, Utilities, Manuals	£799
AMIGA 2000, 1084S MONITOR, 3.5" AND 5.25" DRIVES AND BRIDGE BOARD (giving PC compatibility)	£1099
AS ABOVE, PLUS AMIGA/PC DOS 20 MB HARD DRIVE	£1369
AS ANY ABOVE, BUT ALSO WITH THE WORKS	ADD £50
<i>Note that special prices are available for CBM PCs and other Amiga configurations also - please ring for details. All 2000s have 1.3 Kickstart and latest version motherboard.</i>	
A2088 5 MB RAM EXPANSION, POPULATED TO 2 MB	£449
A2088 XT BRIDGEBOARD WITH 5.25" 360 KB DRIVE	£389
A2288 AT BRIDGEBOARD WITH 5.25" 1.2 MB DRIVE	£359
SPECIAL A5060/2092 20 MB PC/AMIGA DOS HARD DISC	£299
NOW AVAILABLE A2090A/2092 20 MB AUTO BOOT HARD DISC	£479
A2090A/2094 40 MB AUTO BOOT HARD DISC	£750
A2300 INTERNAL GENLOCK	£187
A2350 BROADCAST QUALITY GENLOCK/FRAMELOCK/FRAMEGRABBER	£545
A2032 PAL COMPOSITE VIDEO CARD	£69
A2010 INTERNAL 3.5" DRIVE	£105
A2620 68020 CO PROCESSOR	£1045
14" HIGH RES COLOUR MONITOR (Needs video Card & Cables)	£579
CABLES FOR HRCM	£29
VIDEO CARD FOR HRCM (FLICKER FIXER)	£299
CHERRY DIGITISING PAD AND DRIVER	£499
Prices inc. VAT.	

AMSTRAD 1640 AND CBM SUMMER PACKS

1640 with Wordstar, Supercalc and Accounts Master Software, PLUS DMP 4000 NLQ Printer Mono Dual Drive	£799
Mono, Single Drive with 30MB Hard Card	£999
ECD	ADD £200
COMMODORE PC20 MONO WITH 1230 NLQ PRINTER	£749.00
All prices inc. VAT.	

AMIGA 500 PACKS: GAMES PACK

Inc. Modulator, 24 games on 4 discs; Arcade, Adventure, Board and Shoot-em-up games, joystick, plus:
8 additional individually packaged games from the following list: Return of the Jedi, Eliminator, Custodian, Power Play, Mercenary, Znapse, Hell Bent, Warlock Quest, Harrier Command, Demolition, Grid Start, Spitting Image, Art of Chess, Amegas
Also with 1084S monitor or LC10 colour printer

£385 inc. VAT.
£610 inc. VAT.

AIR MILES PACK

Inc. Modulator, 24 games on four discs; Arcade, Adventure, Board and Shoot-em-up games, joystick, plus:
3 additional individually boxed games, Spritz Art package
AND 500 AIR MILES (Paris or Amsterdam is 450)
Also with 1084S monitor or LC10 colour printer

£409 inc. VAT
£635 inc. VAT.

PROFESSIONAL PACK

Inc. Modulator, 24 games on 4 discs; Arcade, Adventure, Board and Shoot-em-up games, plus:
The Works Spreadsheet, Database, Spreadsheet
OR Publishers Choice
Also with 1084S monitor or LC10 colour printer

£435 inc. VAT
£450 inc. VAT.
ADD £225

EXPANDED PACK

Inc. Modulator, 24 games on 4 discs; Arcade, Adventure, Board and Shoot-em-up games, plus:
A501 RAM Expansion and Dragons Lair
Also with 1084S monitor or LC10 colour printer

£539 inc. VAT
£764 inc. VAT.

AMIGA SOFTWARE SPECIALS

Photon Paint II	£62.95	Dragons Lair	£29.95
Deluxe Paint III	£62.95	All books 10% off	
Transformer	£19.95	BEST PRICES ON ALL SOFTWARE -	
XCAD Designer	£82.99	WE CAN NORMALLY MATCH OR	
XCAD Professional	£329.95	BEAT ANY GENUINE ADVERTISED	
Publishers Choice	£73.95	PRICE. Software prices inc.	
Critics Choice	£109.95	VAT & PP.	

* ORDERING

To place your order, send cheque, postal order or official order, plus £8 per box (software free) for next day courier delivery and VAT to Dept. NCE, Hobbyte Computers Ltd, 10 Market Place, St Albans, Herts AL3 5DG, or call with a copy of this ad at our branches in St Albans and Luton. You may also phone your order to our sales desk on St Albans (0727) 56005.

10 THE ARNDAL CENTRE | 10 MARKET PLACE
LUTON, BEDS, LU1 2PG | ST ALBANS, HERTS, AL3 5DG
TEL: (0582) 457195/411281 | TEL: (0727) 41396/56005

NO DEPOSIT INSTANT
CREDIT AVAILABLE -
WRITTEN DETAILS ON
REQUEST, TYPICAL APR 29.9%

All prices are ex-VAT except where stated
Prices correct at time of going to press, but subject to
change without notice. E & DE.

LOW PRICE COMPUTER SUPPLIES

Amiga 512K switchable memory expansion	£84.95
Amiga 512K switchable memory expansion with battery backed clock	£94.95

Lifetime Guarantee Disks, 100% Error Free. Supplied with labels & tape

	Qty	10	25	50	100	150	200	300	500
3 1/2" DS/DD (135 TPI)	1	7.50	18.50	35.50	88.50	99.50	128.50	188.00	300.00
Sony branded	1	12.00	N/A	57.50	112.50	167.00	220.50	325.00	530.00
3 1/2" DS/HD (2mb)	1	25.00	61.00	120.00	238.00	355.50	472.00	699.50	Phone
3 1/2" Sony branded	1	36.50	N/A	178.00	353.00	526.50	699.00	Phone	Phone
5 1/4" (96 TPI)	1	3.50	8.00	15.00	28.50	41.00	53.00	77.50	126.00
3 1/2" Sony branded	1	12.00	N/A	59.00	116.50	172.00	226.00	336.00	548.00
3" (Amsoft)	1	23.50	N/A	112.50	219.50	327.00	433.00	643.50	Phone

disk boxes lockable with two keys and dividers

3 1/2" 40 Capacity	£3.95	80 Capacity	£5.95
5 1/4" 60 Capacity	£3.95	100 Capacity	£5.95
10 Capacity library cases (3 1/2", 5 1/4" or 3")			£1.25
10 Capacity 5 1/4" disk rack with stationery tidy			£6.50
Head cleaners with fluid (3 1/2" or 5 1/4")	£1.95 (3")		£2.95
Mouse mats (Blue, Red or Grey)			£3.50
Thingy copy holders, attach to your monitor for easier readability			£2.50
Universal printer stand, fits most printers			£7.95
12"-14" monitor stand, 360 degrees swivel and 25 degrees tilt			£9.95
Computer dust covers for Amiga, ST, etc			£5.95

Add £1 P&P if order value is less than £10. Prices include VAT.

C & M MICROS

25 Middlefield Road, Bessacarr, Doncaster, S. Yorks, DN4 7EB
Telephone (0302) 539955

ALL
TRADE
ENQUIRIES
WELCOME

MEDIAWARE

ALL PRICES
EXCLUDE VAT

OFFICIAL TENDERS &
QUOTATIONS WELCOME

NEW PRODUCTS,

NEW PRICES

HARD CARDS



WESTERN DIGITAL 20MB	179.00
WESTERN DIGITAL 30MB	195.00
WESTERN DIGITAL 40MB	279.00
<i>(Including XTREE Software)</i>	
SEAGATE 40MS 20MB	189.00
SEAGATE 40MS 32MB	205.00
SEAGATE CARD 38%	
FASTER THAN THE	
AVERAGE 65MS CARDS	

HARD DRIVE KIT

SEAGATE DRIVES	
INCLUDING CONTROLLER AND CABLE	
ST-225 - 20MB 65ms	164.50
ST-251 - 40MB 40ms	269.00
ST-4096 - 80MB 28ms	419.00
ST-138 - 30MB 40ms	245.00
ST-138R - 30MB 45ms	210.00

WANGTEK TAPE STREAMERS

FOR FULL RANGE CALL FOR PRICES	
40MB 1/2 Hight, Wt, PCXT/AT/386	280.00
60MB 1/2 Hight, Wt, PCXT/AT/386	525.00
40MB External, PCXT/AT/386	359.00
60MB External, PCXT/AT/386	575.00

3M DATA CARTRIDGES

DC1000	13.50
DC2000	16.00
DC600A	19.00
DC600XTD	18.00
CALL FOR ANY OTHERS PLEASE	

ORCHID VGA CARDS

DESIGNER 800	199.00
PRO DESIGNER	295.00
PRO DESIGNER PLUS	389.00
DICO EGA HIGH RES.	129.00

MANUAL DATA SWITCHES



SERIAL/RS232 2 WAY	12.50
SERIAL/RS232 4 WAY	18.50
SERIAL/RS232 X-OVER	19.95
PARALLEL/CENT 2 WAY	14.00
PARALLEL/CENT 4 WAY	19.50
PARALLEL/CENT X-OVER	20.95

CABLES

2m IBM Printer Cable	6.00
3m IBM Printer Cable	6.95
2m BBC Printer Cable	5.50
2m RS232 M/F	5.00
2m RS232 M/M	5.00
2m Cent/Cent M/M 36C	6.50

PRINTERS

Panasonic



KX-P1081	125.00
KX-P1180	150.00
KX-P1124	254.00
KX-P1592	268.00
KX-P1595	315.00
KX-P1540	410.00

EPSON

LX-800	145.00
FX-850	310.00
FX-1050	399.00
EX-800	420.00
EX-1000	565.00
LQ-850	399.90
LQ-1050	539.00
LQ-2250	844.00

STAR

LC-10	148.00
LC-10 COLOUR	190.00
LC-2410	254.50
NX-15	260.00
FR10	305.00
FR15	400.50
XB24-10	408.00
XB24-15	535.00

NEC

P2200	259.00
P6+	420.00
P7+	539.00
P9XL	780.00

LASER PRINTERS



PRICES TOO LOW TO ADVERTISE

PANASONIC KX-P4450	CALL
STAR LASER PRINTER 8	CALL
HP LASER II	CALL
EPSON GQ3500	CALL
KYOCERA F1000 HQ	CALL

TONER CARTRIDGES

HP LASER JET I	57.50
HP LASER JET MK II	58.50
PANASONIC KXP BOT.	28.00
KYOCERA 2 PACK	68.00
CANON A1/A2	59.95
EPSON GQ3500	16.50
QUME 2 PACK	89.00

ALSO AVAILABLE: FONTS, CUT SHEET FEEDERS, RIBBON PAPER, CLEANING KIT, INTERFACE CARDS, MONITORS - CALL NOW

5 1/4" BULK DISKS, ENVELOPES AND LABELS

	50	250	500	1000
SSDD 48tpi	.26	.23	.20	.19
DSDD 48tpi	.27	.25	.24	.22
DSDD 96tpi	.32	.29	.28	.26
DSDH 1.6Mb	.52	.49	.48	.46

3 1/2" BULK DISKS, ENVELOPES AND LABELS

SSDD	.69	.65	.63	.59
DSDD	.79	.75	.73	.69
DSDH	1.65	1.63	1.58	1.49

CHOOSE FROM ANY OF THE FOLLOWING BRANDS

JVC Verbatim. SONY. 3M

BRANDED DISKS FROM £4.90 per box

BOXES OF 10	1-2	3-9	10+
5 1/4" SSDD 48tpi	5.80	5.40	4.90
5 1/4" DSDD 48tpi	6.20	5.80	5.40
5 1/4" DSDD 96tpi	9.50	9.20	8.80
5 1/4" DSHD 96tpi	9.90	9.60	9.00

3 1/2" SSDD	10.90	10.20	9.90
3 1/2" DSDD	12.50	11.80	10.90
3 1/2" DSHD	27.50	26.95	26.00

STORAGE BOX WITH DISKS

25 x 5 1/4" DS-DD 96 Tpi with 50 capacity LOCKABLE STORAGE BOX	10.86
50 x 5 1/4" DS-DD 96 Tpi with 100 capacity LOCKABLE STORAGE BOX	16.00
25 x 3 1/2" DS-DD 135 Tpi with 40 capacity LOCKABLE STORAGE BOX	19.95
45 x 3 1/2" DS-DD 135 Tpi with 80 capacity LOCKABLE STORAGE BOX	33.00
All disks are certified 100% error free and are supplied with labels.	

LOCKABLE STORAGE BOXES



UNBEATABLE PRICES

3 1/2" 40 Disk Lockable Box	5.99
3 1/2" 80 Disk Lockable Box	6.50
5 1/4" 50 Disk Lockable Box	5.99
5 1/4" 100 Disk Lockable Box	6.50

HOW TO ORDER

By Telephone: 0270 666616/
0270 664236
By Post: Address Below
By Fax: 0270 665556
Personal Callers Welcome

HOW TO PAY

By Visa or Access Card
By Cheque with Bankers Card
By 30 Day Account -
for Official Orders Only.
By Cash

All prices and supplies subject to change without notification.

DIAL-A-DISK



MEDIAWARE LIMITED

Unit 9 Huntsbank Industrial Estate,
Crewe Road, Wistaston, Crewe, Cheshire CW2 6QT
Telephone: 0270 666616/664236



FAX-A-DISK

0270 666616

MEDIAWARE

0270 665556

Amiga multi-user

W. Oliver of Hampstead, London writes:

Q I have an Amiga A500 and access to a dumb terminal and I wonder whether it would be possible to use the two together. I know that the Amiga multi-tasks but is it multi-user? The terminal has a standard 25-way D connector and is RS232-compatible. If connection is possible, could you show me a wiring diagram to connect the two?

A It is possible to use a terminal with the Amiga and to get it to multi-task in a multi-user kind of way. You will need Workbench 1.3 and the AUX: device.

This is like the SER: device but does not buffer any data being transferred. To set up the link, make sure both machines are off before connecting them; the Amiga serial chips have a habit of going kaput if you connect things to them while the machine is powered up.

Next, boot the Amiga and switch on the terminal. Set them both to the same RS232 speed, e.g., 9,600 bps and eight bits, 1 stop bit, no parity. Then enter MOUNT AUX: on the Amiga to set up the new serial device. Follow this with RUN

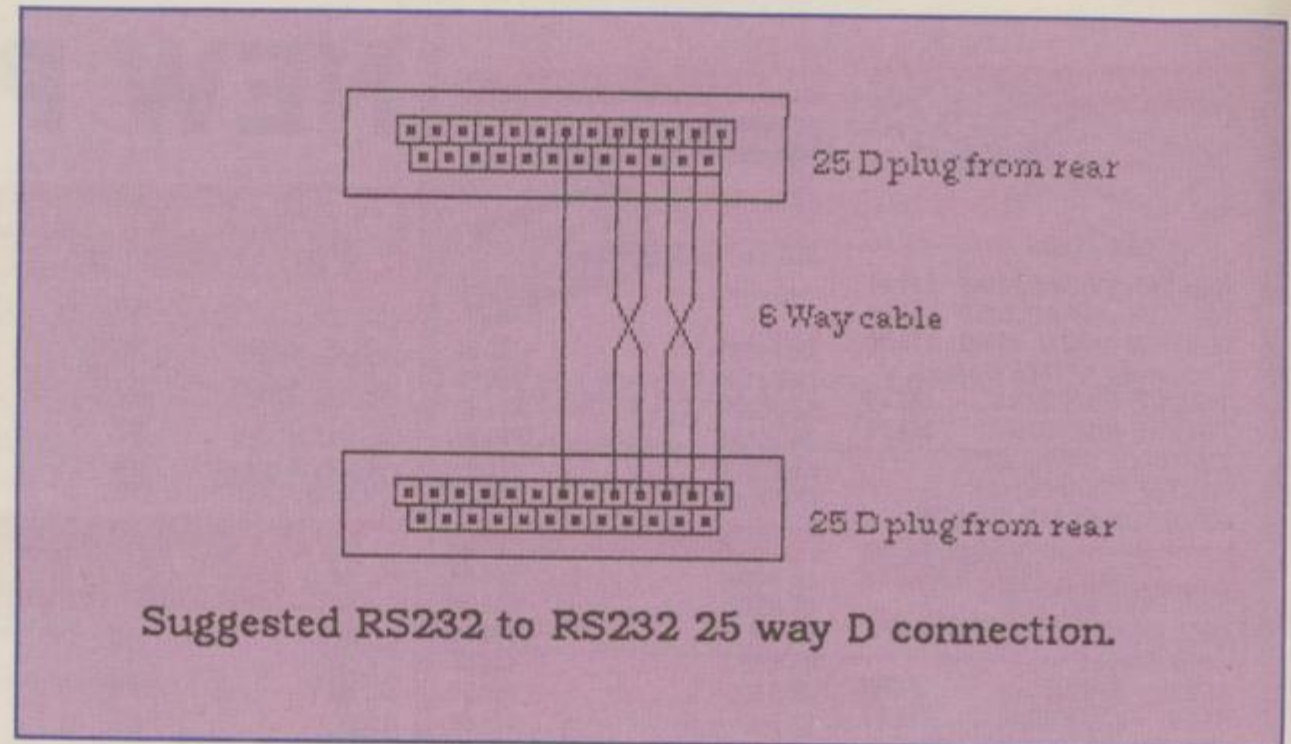

NEWCLI AUX: which sets up a new CLI window but directs all input and output via the RS232. You should see a prompt - say 3> - appear on the terminal. If so, you are in business. If not, check the speeds, word length and so on, and then the wiring of the connecting cable. The suggested wiring shown works for my Amiga connected to an ST, i.e., both serial ports are the same pin-out; all that needs to

be done is to reverse TX and RX, and RTS and CTS.

Unfortunately, the terminal has a number of limitations and obviously cannot run graphics-based applications. It can really operate only the CLI commands as other applications will not operate through the serial port.

If the Amiga had more than one RS232 it would be possible to attach a few terminals to the

system but the machine would slow a good deal, especially when performing disc transfers.

Incidentally, if you do not have Workbench 1.3, it is well worth spending the extra £15 or so for the upgrade. It is available from most Amiga dealers and extends most of the CLI commands and provides a number of new devices, plus an improved CLI called SHELL.

BBC buffers

T. Wilkins of Deal, Kent writes:

Q I am writing to you because you seem to be one of the few people who still support the old BBC micro model B. I would like

help with the RS432 buffers and how to get characters into and out of them.

A There are two OSBYTE commands which make this reasonably easy. There are nine main buffers in the BBC:

- 0 - Keyboard buffer
- 1 - RS432 input
- 2 - RS432 output
- 3 - Printer buffer (Centronics output)
- 4 - Sound channel 0
- 5 - Sound channel 1
- 6 - Sound channel 2
- 7 - Sound channel 3
- 8 - Speech

OSBYTE 145 gets a character from the specified buffer and OSBYTE 138 inserts a character. They can be accessed in two ways, e.g., *FX 138 0,65 puts an A into the keyboard buffer. A more flexible way is to use the fact that the CALL command uses the contents of A%, X%, and Y% for the 6502 registers A, X, and Y. So, to perform *FX 138,0,65, the following snippet of program would be used:

```
A%=138:X%=0:Y%=65
CALL&FFF4
```

A procedure to do this is shown. Getting characters from the RS432 receive buffer requires a little more fiddling. The operating system does not return values in A%, X% and so on. Instead the USR function must be used to get the contents of the registers.

```
DEFPROCTX(C$)
A%=138:X%=2
Y%=ASC(C%)
CALL&FFF4
ENDPROC
```

BBC RS432 transmit procedure.

```
DEFFNRX
REPEAT
A%=145:Y%=1
T%=USR(&FFF4) AND &FF0000
UNTIL T%<>0
=CHR$(T%/&10000)
```

BBC RS432 receive function.

Basic

Peter Wells of Melton Mowbray, Leicestershire, writes:

Q I know you have been asked this previously but I cannot find the back issue with the answer. Could you tell me what Basic stands for?

A Beginners All-purpose Symbolic Instruction Code.

New ST mouse

N. Perry of Telford, Shropshire writes:

Q Recently I had an accident whereby I broke my ST mouse. Can you tell me where I can get another and how much it would cost?

A A few Atari dealers supply new mice. The average price seems to be about £26. Try Microsnips, 051 691 2008, £25; Datel Electronics, 0782 744707, £30; Apolonia Software, 01-738 8400, £23.

Ladbroke Computing supplies a tracker ball alternative, £20, 0772 203166.

PC emulator - Amiga

Ian Inman of Stanley, Co. Durham writes:

Q I have heard of programs known as PC emulators, enabling PC software to be used on other machines. I am interested in such a program for the Commodore Amiga 500 as it will be useful to

me. Could you recommend one reasonably affordable which can run as wide a range of PC software as possible?

Also, to use one, will I need a 5.25in. disc drive? If so, again, can you recommend a fairly cheap but reliable one? Can you recommend a suitable lead which would allow me to record sound from my Amiga on either a cassette recorder or hi-fi

system, preferably the former?

A I know of no software PC emulator for the Amiga. There may be one available; perhaps our readers know? There is certainly one available for the ST so it cannot be particularly difficult. Normally, PC emulation on the Amiga is performed by means of the bridge board, an add-on which includes an XT- or AT-compatible

microprocessor, depending on the board, and enables the Amiga to operate exactly like a PC. Unfortunately this works only on the A2000, so far as I know. Does anyone know of a bridge board for the A500?

As regards the disc size used, many PC compatibles these days use 3.5in. discs which can certainly be read by the Amiga internal drive, so I should think a 5.25in. drive would be fairly redundant.

Connecting your Amiga to a tape recorder or a hi-fi is easy. It is probably the easiest machine for doing it. The Amiga sound output is via two RCA phono sockets at the back. It is stereo, so one must go to the left channel and one to the right.

The hi-fi connection is easiest, since all you need is a dual phono to dual phono lead, it is available from almost all hi-fi shops.

This pre-supposes that your hi-fi has the standard RCA phono connectors, which it should have if it is less than 10 years old.

If your connections are different you will have to figure the pin-outs and ask the hi-fi dealer if such a lead exists; it almost certainly will.

I have shown the two commonest connections in the accompanying diagram.

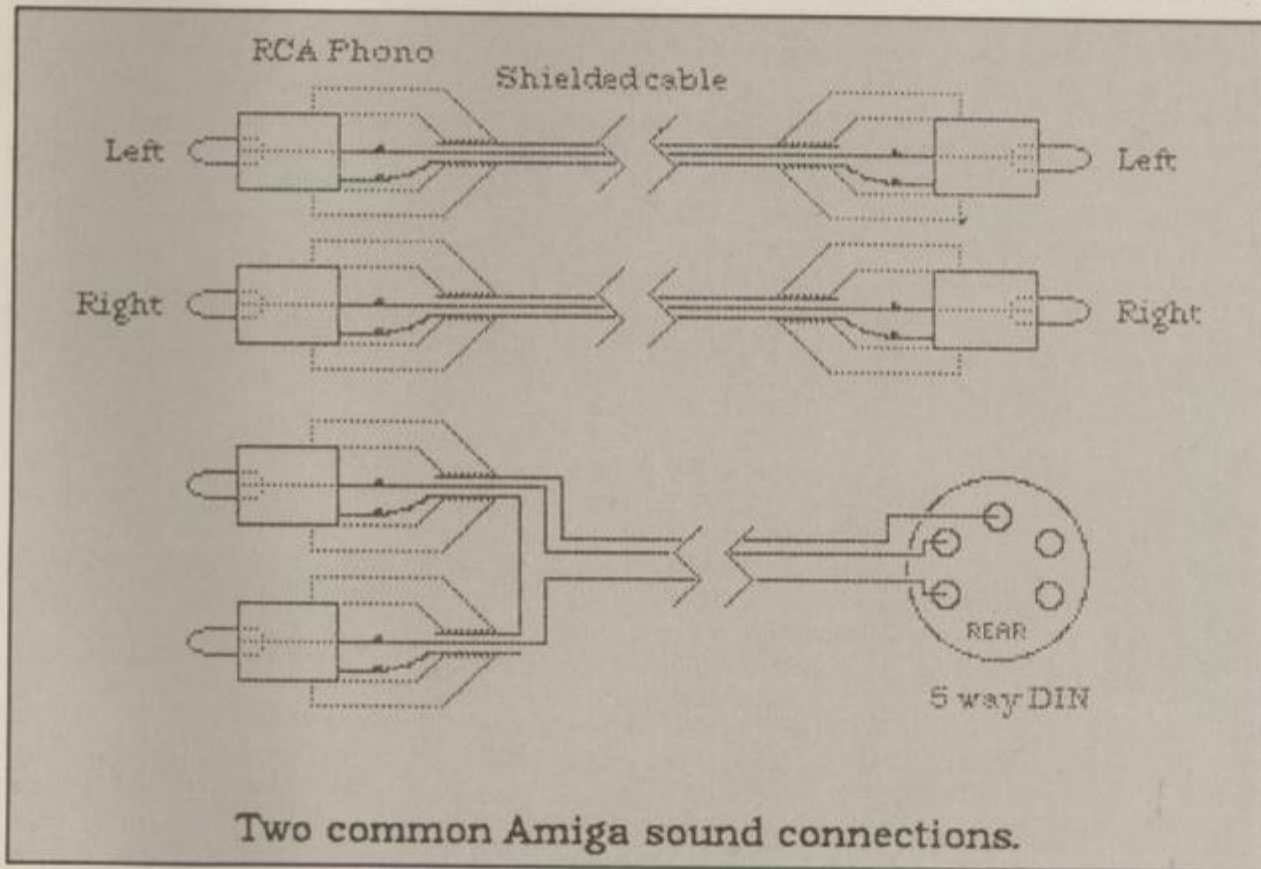

Spectrum Cheap Joy

M Holden of Broadstairs, Kent writes:

Q I read with interest your Spectrum joystick interface article - June 29 - but note that you feel it may not work with some software. I thought you might like to see a diagram for an interface which uses In 255, i.e. Kempston Standard, but may be constructed for less than half the cost of your design. I built the unit in a K'tronics keyboard along with a Sinclair 1/2 format interface and three stick sockets. It operated successfully with old and new software for more than two years; the Sinclair standard interface uses 74LS08, 138,244 and 10 resistors. It is not very pretty so I have not included details, but it works.

I use a Ferguson MC01 television set for my display which also has an RGB input. RGB sound and earth are satisfactory but what are sync1 and sync2? Is the input analogue or TTL compatible? Do you or any readers have a circuit suitable for an RGB interface to the MC01? Finally, would an RGB display be

better than the composite video signal I use at the moment from UHF mixer input?

I realise Ferguson used to make an interface to suit the Spectrum but I would like to save some money and leave the edge connector free by building it inside the keyboard.

A I suspect my mistake was in using the 8212 chip as this is rather expensive compared to the 74LS366. If you want to interface other gadgets to the Spectrum, the 8212 is a versatile device; for just a joystick interface your solution is better and cheaper. Thank you for sending it.

With respect to your questions, I admit that I am no expert on the Ferguson MC01. I think sync1 and sync2 are probably inputs - outputs? - for the horizontal and vertical syncs. Presumably they could be used with, say, the ST which produces separate sync signals.

Whether the RGB in the Ferguson is analogue or digital I do not know but I suspect that it is digital as I have seen wiring diagrams for using it with the Spectrum 128+ and the like which use digital RGB so far as I know.

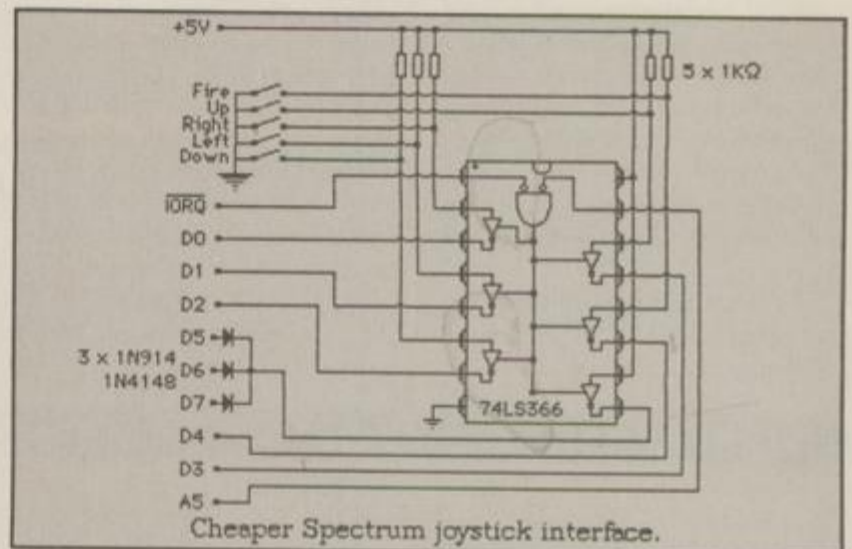

Unfortunately I do not have a circuit to convert the Spectrum composite video signals to RGB; as you say, adapters exist, so if anyone knows the details send them to me and I will let everyone in on the secret. I may be wrong but most video systems start with RGB signals at some point in their circuitry. They are then converted to composite video and pushed through a UHF modulator for use with a TV. I can only presume that the Spectrum does this as well; what you need is a circuit diagram for it.

The normal method of producing a video image is to get values for the RGB levels from the computer memory image.

These three signals are combined to form composite video and then a UHF signal. All this playing around introduces distortion, so an RGB signal, straight from the source, should produce the best image. I suspect that the adapters which produce RGB for the Spectrum split the composite signal and so introduce yet more distortion.

Keeping up with the Clives'

When I bought my ZX-81 with its rickety RAM pack and squidgy keyboard I definitely felt that I had entered a new stage of my career. Suddenly I had become part of the computer revolution instead of being an onlooker. Many of the programs being published then were fairly elementary and written in Basic. Aliens were graphics characters which staggered across the screen and which were shot down by painfully slow missiles.

You could understand the programs, change them, improve them or write better ones. You felt like a pioneer and the letters and articles in the magazines reinforced that; we were all seekers looking for an understanding of this marvellous equipment on which we had laid our hands and looking for problems to solve on it. The lure of obtaining a second income or even becoming fully independent to work in the comfort of your own home beckoned.

The limitations of the ZX-81 quickly became obvious and I graduated to the Commodore 64 to get my hands on a real home computer with reasonably high-resolution graphics, colour, sound and a proper keyboard. The horizon had expanded. Nothing seemed impossible and I made some money out of it by using the computer for word processing and getting a few small programs published. Even then it appeared that it was possible to reach the level of the professionals with some application.

I did some business programming and learned at first hand what the computer books do not

tell you – professional-level programming is sheer hard work calling for a high degree of concentration and attention to detail. They do not mention the need to acquire the ability to second-guess what an inexperienced user will make of your on-screen text messages and the need to make the program bug-free and error-trapped.

Writing programs is not so easy as it looks and I expect that there are many computers collecting dust in cupboards after owners abandoned the dream of becoming a programmer.



Undaunted, I struggled to master machine code and improve my Basic to try to learn how to write high-quality programs. Even as I was doing so a new generation of computers was appearing on the market. They had very high-resolution graphics, a superb range of colours, hi-fi quality sound and a complication to match. Games programs became a pleasure to watch because of the quality of the graphics, even though they were the same old plots

reshaped time and again.

Aliens had gone from blobs to detailed figures which interacted with each other; the background music was now a recognisable tune and the scenery rolled smoothly across the picture. Competitions appeared to encourage graphics programmers to display their best work.

The quality of some of the winning pictures was so good that you had to look twice to see if they were not really photographs. There were those sequences of swinging, shiny balls complete with accurate and changing reflections. Real art, beautiful things which must have taken hundreds of hours of work to create. Some of the finest sequences appear on television where it is becoming increasingly difficult to distinguish the computer-generated from the real.

I can only stand back and admire such industry, I know I cannot emulate it. I do not have the equipment, the expertise or time. Nor am I likely to acquire it; the technology has advanced out of my reach and I cannot keep up with it. I have moved a step back to become a user rather than a creator. It is not that I have lost interest – far from it; the fascination lingers but I spend more time writing about it than doing it.

Fortunately, no program has yet been written which can generate even simple articles. I do not resent being out of the mainstream of computing but the advances in technology have taken away my dreams. Where has the magic of those early days gone?

Peter Graves

NEXT WEEK

On sale Thursday, August 10th – Just 55p!

ELECTRONIC TIMES

Interceptor, Populous, Battle Chess, Bards Tale, Powerdrome – yes EA have a lot to talk about. We shoved a tape recorder in the window and listened in.

FLY BY NIGHT

Lee Paddon goes on another sortie around a Worcester living room – this time in Dave Marshall's F-16 Combat Pilot.

AUCTION

Cheap and cheerful micros can be had at lower than bargain prices – if you know where to look.

PRINT DUMP

Yet another Printer launched and yes, your caring sharing, digging and delving Pop scribes were there to review the machine.

Plus...

All the LATEST news from the U.K. and the U.S., techie-time with Kenn Garroch, your listings, our reviews of the best games of the week and your letters. And Vince Wong might just creep in (who he – ed?).

INTERFACE BY BRIAN COOKMAN



WIN
 Second Drive
 and a year's supply
 of New Titles published by
 Gainstar NOW!!!
 LOOK BELOW FOR MORE
 INFORMATION

TARGHAN

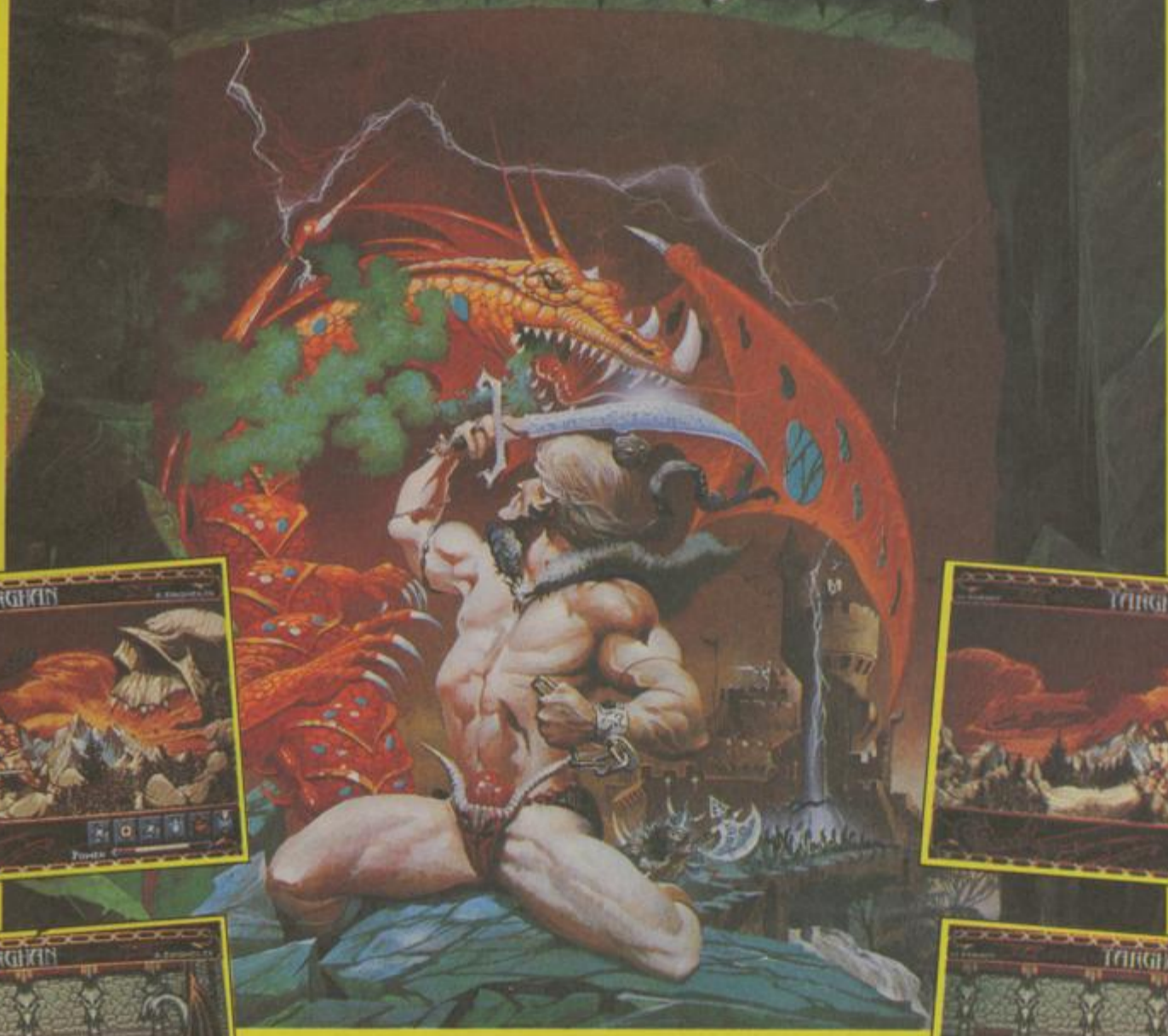

DEALER
 ENQUIRIES
 WELCOME
 SPECIAL
 DISCOUNTS
 Distributor
 enquiries
 welcome



Targhan

Far from Edengarhn is the castle of the evil one.

Far from your village, a lord keeps the secret, such a powerful lord that he cannot be human, a creature floating a world that dies and grows again.

Targhan is probably the most stunning game you'll ever play.

Targhan is an adventure-action game with more than 120 landscapes and 40 different characters. The game is playable on either keyboard or joystick.

The game offers digitised sound and outstanding graphics.

It will be released on Amiga, Atari and PC (EGA, VGA and CGA) by the end of May. The game will run on both colour and mono screens.

Look for reviews in
 Commodore User,
 Popular, The One,
 C&VG, Ace,
 ZAP, The
 Games Machine
 and Amiga User
 International soon!



Silmarils

To enter our competition please send your warranty cards of TARGHAN and complete the following:

I like the game Targhan because

Send your entries to: UNIT 1 (Rear of 7), WELLINGTON ROAD, SANDHURST, SURREY GU17 8AW ☎ (0252) 877431-879718 • Fax: (0252) 877431

Closing date September 1, 1989.



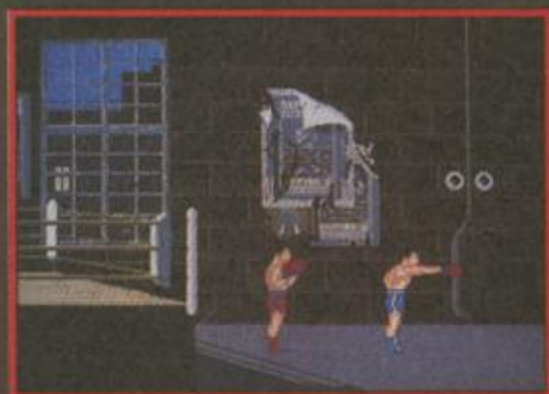

SKATE OF THE ART

The crazy game for all Skateboard fans
Out on the **Amiga** from mid July.
Don't miss it...

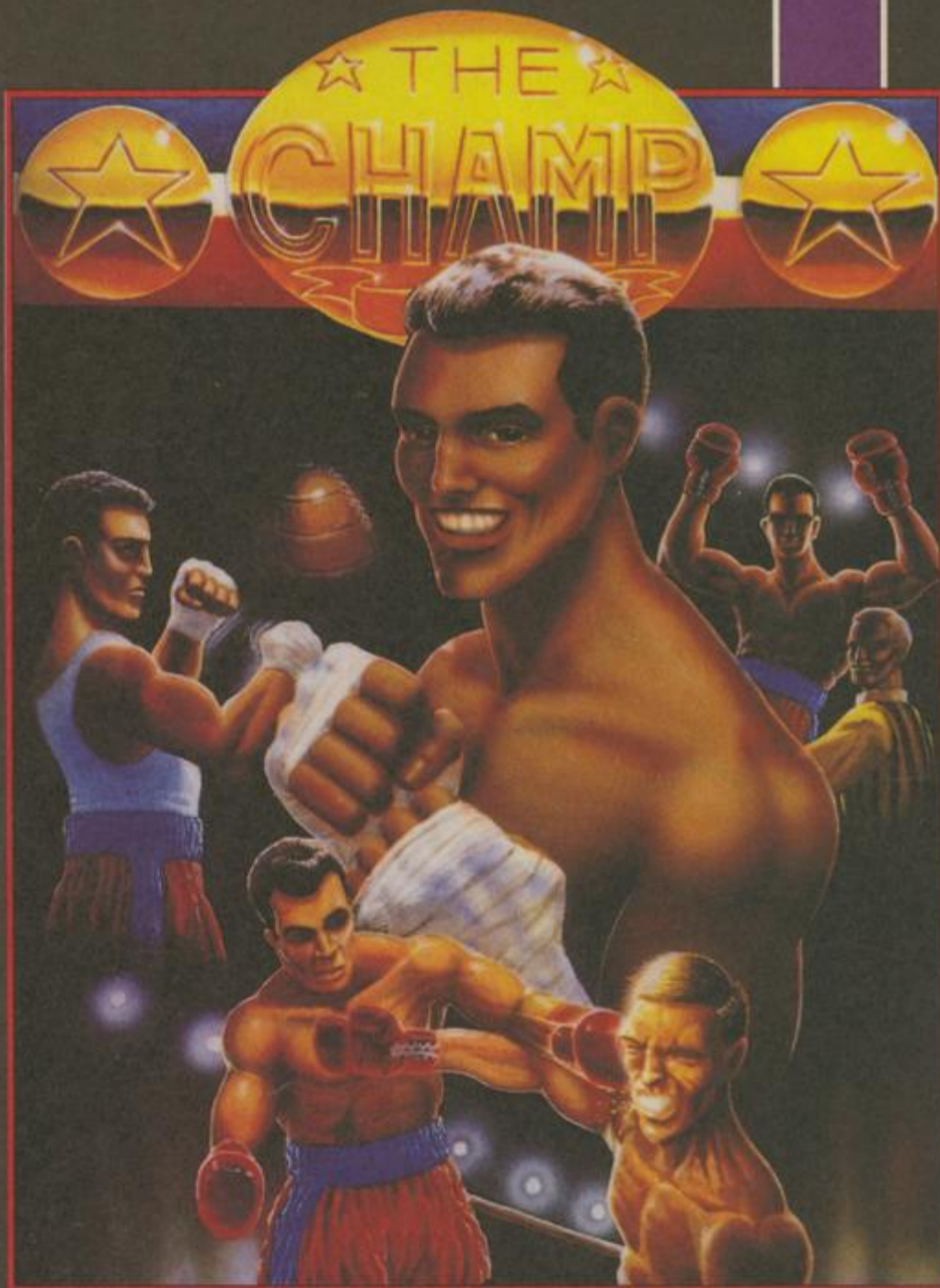

THE CHAMP

Endorse by the **WORLD BOXING COUNCIL**, **THE CHAMP** is simply the most realistic boxing simulation ever written for the computer:

- With the original '**Rocky**' theme tune -
- More than 1300 Frames of animation -
- One or two player mode -

A Booklet with the history and rules of boxing -

- Keyring with mini boxing gloves -
and a lot more. No surprise that everyone is enthusiastic about it: TILT HIT in France, SMASH GOLDMEDAL in Germany ... a great simulation.

Now available for **Amiga** soon out on **Atari ST, C64, Amstrad and Spectrum**

Distributed by

SOFTWARE SUCCESS MARKETING LTD

Alban House
24a White Pit Lane
Flackwellheath
Nr High Wycombe
Buckinghamshire HP10 9HR

LINEL

LINEL Products MERIMPEX Ltd

Am Schrägen Weg 2, 9490 Vaduz
Principality of Liechtenstein
Tel: 01041 75 283 68
Fax: 01041 75 206 56