

POPULAR 55p

computing WEEKLY

SEPT 28 - OCT 4 1989

Friend
ISSUE 380

DOSSER'S LOCOSCRIPT

LOCOMOTIVE'S WORD PROCESSOR
MOVES FROM CP/M TO DOS, p.2



GRAPHICS STRANGLER?

QUANTEL WINS PATENT RIGHTS TO
BASIC COMPUTER GRAPHICS
TECHNOLOGIES, p.5

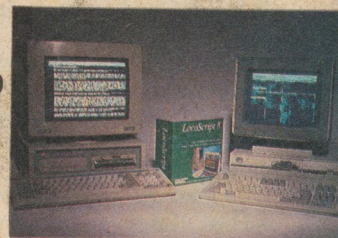

**NEW
LOOK
ISSUE!**

**BATMAN
BUNDLE!**

**SPECTRUM
SAMPLER!**

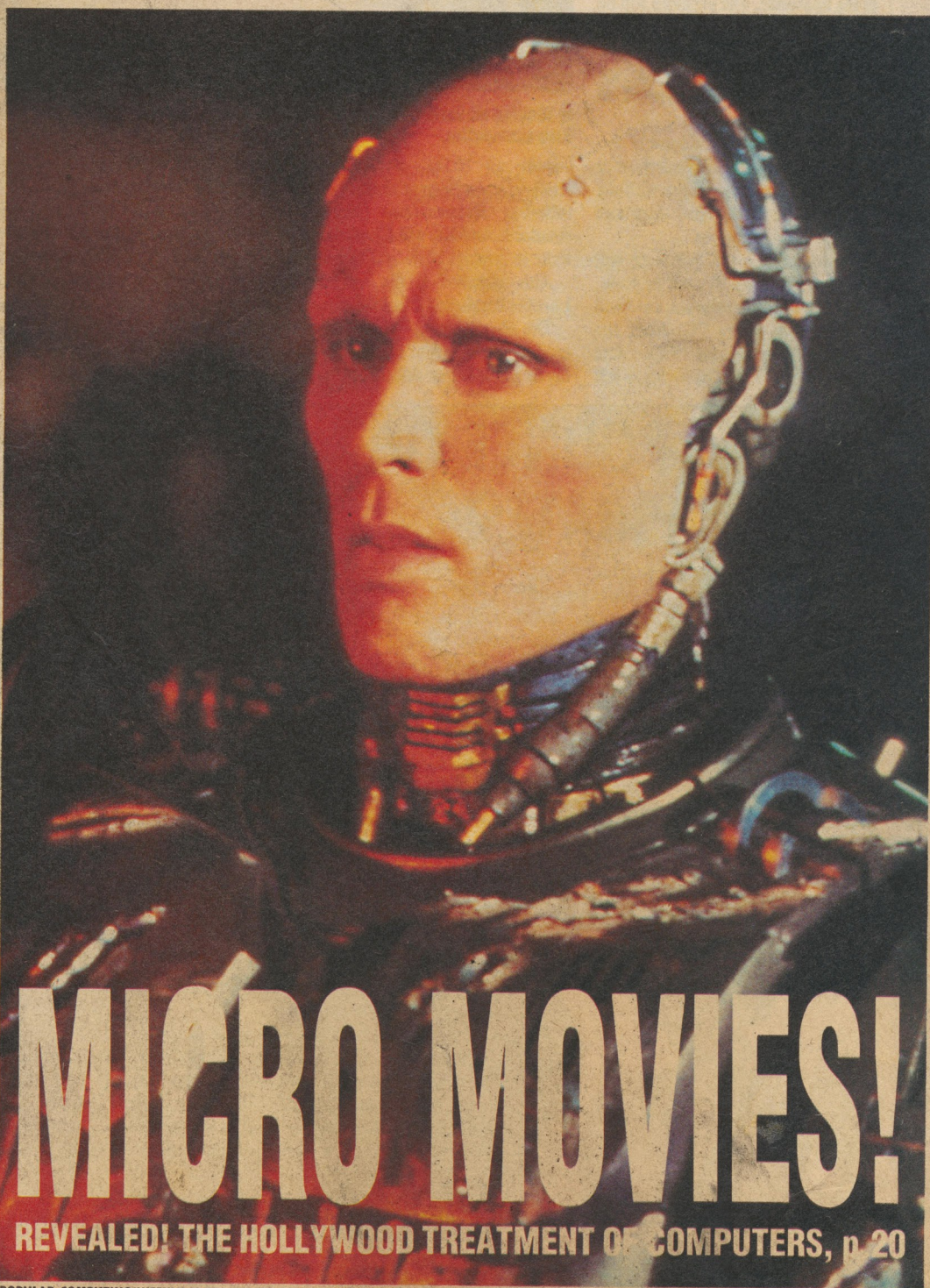

MICRO MOVIES!

REVEALED! THE HOLLYWOOD TREATMENT OF COMPUTERS, p.20



POPULAR COMPUTING WEEKLY IS REGISTERED AT THE POST OFFICE AS A NEWSPAPER

PC LOCOSCRIPT "READY" – BUT FOR NEXT EASTER!

A FILLIP in PC sales can be expected next February when entry level WP pioneer Locomotive Software launches a PC version of its flagship CP/M based word processor, Locoscript.

PC *Locoscript* will be previewed to users and dealers at this week's Earls Court PC Show – but the authors are keen to stress that the software is by no means ready for market.

The show preview, says Locomotive boss, Howard Fisher, will allow users' suggestions to be incorporated in the final code. The program will be priced at £125, or £99 (both plus VAT) to existing Locoscript users. Dealers are currently being approached to establish a network of sales outlets.

The program is considerably different to the new PCW version, since the software must now cope with the curiosities of DOS, hard discs and multiple printer options.

Full details on the WP were still under wraps as PCW went to press, but it is known that the software will run on almost any PC, from the cheapest monochrome 512K dual floppy PC upwards. The software will

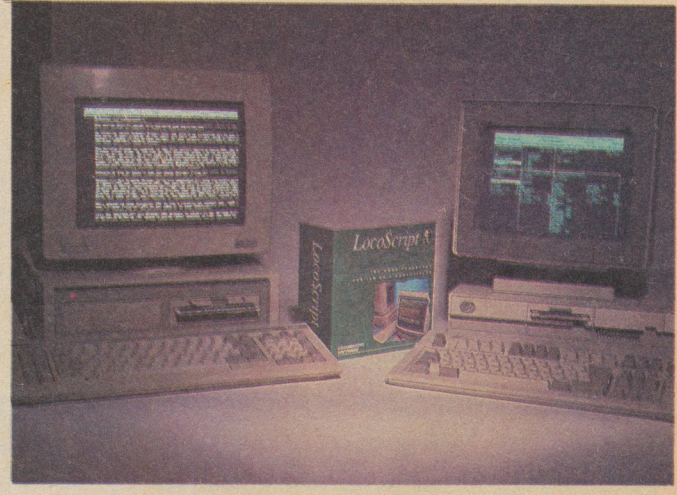

● Making an Earls Court debut, the multilingual wordprocessing package from Locomotive.

include an 80,000 word spelling checker, and a heap of character sets including Russian and Greek as standard. Add ons will allow users to write in Arabic, Urdu and Hebrew.

Also included is the integrated Locofile database and a mail merger.

The Locomotive penchant for user-friendliness looks like being adhered to with this release. New PC

users often struggle to get their US originated word processors to produce anglicised characters, but Locomotive technical director Richard Clayton says PC Locoscript at least performs this task with ease. "This is a word processor that users can purchase and use immediately. They don't need to be experts just to produce a simple pound sign."

POLICE POUNCE ON PARIS 'PIRATES'

GST SOFTWARE Products, whose range includes Timeworks Publisher and Typografica, has taken firm measures against suspected software counterfeiters in France.

Police swooped on the premises of Wings Micro Electronics in Paris, which had formerly been distributing GST's Desktop-publishing packages. In the biggest raid of its kind in France, a substantial amount of al-

leged counterfeit software was seized.

GST boss David Rose said: "40 percent of our products are sold outside the UK and France is one of our most important markets. Software piracy is a threat to all our customers from the distributor to the retailer and the consumer – and the action we have taken will help to protect all parties."

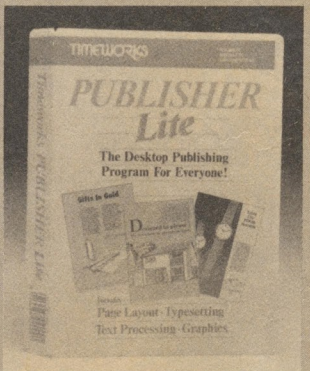

■ The real thing or a clever foreign counterfeit? GST swoops on distributors.



MISUNDERSTOOD

THE SOUND of Mrs. Thatcher's voice proved too much for a computer in Japan last week. The incident occurred during a visit to Fujitsu's high-tech factory organised to recognise the company's investment in Britain.

Fujitsu president, Mr. Takuma Yamamoto, set up a demonstration of one of its "intelligent computers" which was supposed to translate Mrs. Thatcher's words, entered through a keyboard, from English into Japanese. Owing to a glitch, however, her speech expressing what an honour and a pleasure it was to be visiting the company became translated to: "This company, having been visited by me today, is honourable".

With her majesterial reputation preceding her, perhaps her Japanese hosts didn't realise the computer had made a mistake . .

THIS WEEK

LETTERS9

Better bingo calling . . .
Falcon disc problem . . .
Hard drive prices. . . and more.

SOUNDCHECK11

Mastersound on the Spectrum for under £40.

THE HISTORY OF COMPUTING12

The second part of Kenn Garroch's excursion through the micro's forebears.

HOTLINES16

Duncan Evans interrupts a game of bowls to bring you news of The Spanish Armada and other battles.

GAMES19

PASSING SHOT . . . an ace game?
SHUFFLEPUCK CAFE . . . pub games in the 25th century.

COMPUTERS IN THE MOVIES20

A look through the reels which have given micros their big breaks in the cinema.

PUZZLE22

It's only a question of time . . .

KENN GARROCH34

ST port address problem, A3000 Mandelbrot programs and more.

FEEDBACK38

Has CD technology got further to go in the home?

POPULAR
computing
WEEKLY

AMAZING BUNDLES FROM COMMODORE

COMMODORE HAS announced the best bundles ever for its Amiga 500 and C64 machines, both to appear in the first week in October.

The Amiga 500 'Batman Pack', including Ocean's 'Batman The Movie' game, is claimed to be the first bundle to include a major game being launched simultaneously.

Also included are the graphics package, *Deluxe Paint II*, and the flight sim, *FA-18 Interceptor*, both from Electronic Arts. For arcade-addicts, *The New Zealand Story* from Ocean has been included as well.

Commodore's marketing manager Jeff Earl commented: "The Amiga 500 - coupled with Ocean's commitment to its own sales activities and Electronic Art's superb reputation - offers just the right marketing mix which will ensure that the Amiga 500 continues to enhance Commodore's leading position in the market."

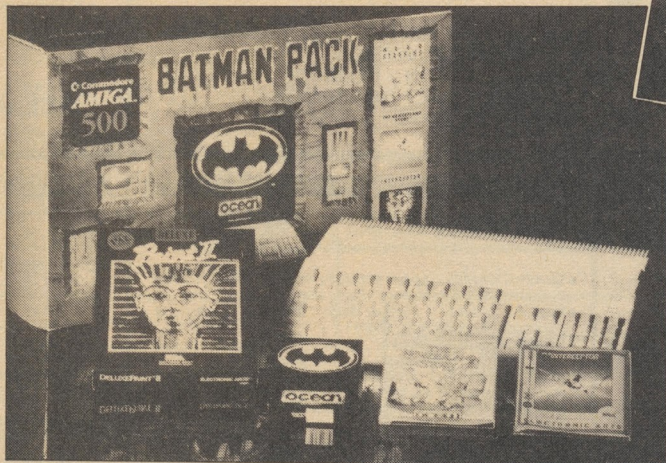

● A jamboree of goodies from Commodore for both graphics and arcade fiends.

'Light Fantastic' is a 3D bundle for the C64 and includes hard/software and peripherals. Jeff Earl said he was "very proud" of what he predicted

would be "the premier 8-bit product bundle ever seen in the market place".

Along with the C64 will be a 3D



◆ The third dimension brought to you with specs and a light gun.

light gun and 3D glasses, 1530 Datasette, and three specially-developed Mindscape games. Also included is *Blaze Out* - a combination of levels from games including *Robocop* and *Rambo III* adapted by Ocean for use with the Commodore Light Gun. And there's more... *Mike Read's Pop Quiz*, a Pitman typing tutor, music package, a paint package and an arcade construction kit.

Prices are £399.99 for the Batman Pack and £149.99 for Light Fantastic with an upgrade available to existing C64-owners for £39.99. Contact Commodore on 0628 770088.

MICRO MAKES A LOVE MATCH

A COMPUTER recently played Cupid to Darren Matthews. Struck dumb and wheelchair-bound since he was mugged two years ago, he was able to tap out, via a portable computer, a declaration of love to the 31 year-old nurse who had cared for him throughout his recuperation. They now plan to settle down together.

IS A MAC IN THE LAP WORTH £4K?

THE MAC PORTABLE has been launched boasting full Macintosh functionality and soft/hardware compatibility in a laptop form.

It has a 16 Mhz Motorola CMOS 68000 processor, chosen to consume 80 percent less battery power and 1 Mbyte of S-RAM (static RAM) which is similarly less power-hungry than DRAM. There is a 1.44 Mbyte floppy disc drive, a trackball which

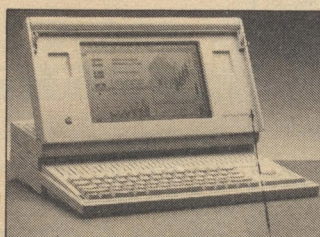

■ Going to print on the Intercity - the Mac laptop with DTP.

can be positioned left or right and a 640 x 400 Active Matrix Liquid Crystal Display screen which is as wide as an A4 page.

Peripherals are catered for with seven external ports. A claimed battery-life of 12 hours is achieved by the inclusion of a power management microprocessor which puts the system in "sleep" mode after a pre-set period of inactivity, and rechargeable lead-acid batteries.

The basic portable, including mouse and AC adaptor, costs £3,995 plus VAT and weighs 13.7 pounds. An optional built-in Mbyte hard disc pushes the price up to £4,495 plus VAT and increases the weight to 15.5 pounds. Hardly an option when the batteries cost £30, the recharger is an extra £90 plus VAT.

Microdealer shuts

MAJOR COMMODORE distributor, Microdealer, ceased trading on September 18. Sources have revealed that relations had been tense between the company's top brass and Robert Maxwell's Mirror Group who own Microdealer.

Based in Milton Keynes, Microdealer were responsible for distributing Commodore hardware and software from various houses. Turnover for 1988 was £9.1 million.

A spokesman for the Mirror Group

said that debtors exceeded creditors and that all creditors would be paid in full. Staff will receive proper compensation and all contractual obligations will be met, he said.

From Commodore, marketing manager Jeff Earl commented: "We are always concerned when a dealer ceases trading but how they manage their business is clearly not a subject which we can comment on. In the case of Microdealer they have been an important element in a network



▲ Jeff Earl: Microdealer's downfall is not a consequence of handling Commodore.

we are building. However, it seems likely that their own business links have been more relevant to this situation than their successful relationship with Commodore."

No sweat

STAR MICRONICS and NEC, will be subjected to European Commission anti-dumping duties if a proposal from Brussels is implemented. But both have vowed not to pass on the cost to the end user.

The Commission has ruled that at least 40 percent of the value of parts used in UK assembly should be of non-Japanese origin. Star Micronics Manufacturing and NEC Technology have been highlighted for failure to meet the requirements by importing 98 percent and 68 percent Japanese parts respectively.

ADVANTAGE

POPULAR SHAREWARE

FROM £2

- POPULAR TRIED & TESTED PROGRAMS
- THE LATEST VERSIONS
- EASY TO RUN - NO MESSY ARCHIVING
- MONEY BACK GUARANTEE
- FAST DESPATCH - FIRST CLASS

PRICES INCLUDE VAT & POSTAGE

ANY 5 DISCS	£13.25
4 DISCS	£11.25
3 DISCS	£9.45
2 DISCS	£6.95
1 DISC	£3.95

OVER 5 DISCS £2.50 EACH

FOR 3.5" FORMAT
ADD £1 PER DISC

CALL 0242 224340 NOW!

WORD/SPREAD/BASES

- PC-WRITE Oulkssoft's Multi-function word Processor
- PC-TYPE II Brand new WP from Buttonware (HD), 4 DISCS
- PC-TYPE+ Fast Spelling Checker, Undo, Help, 4 DISCS
- SAIL Text editor with windowed multi-file mode
- GALAXY Uke Wordstar but with pull-down menus, 2 DISCS
- MINDREADER Brown Bags unique self-learning WP
- PC-OUTUNE Popular brain storming, Idea processor
- SPELLING CHECKER with updateable dictionary
- PC-CALC+ Powerful multi-feature spreadsheet, 3 DISCS
- AS EASY-AS Spreadsheet which is 123 compatible
- OUBECALC A novel 3-dimensional spreadsheet
- GOALSEEKER Timesaving utility helps create spreadsheets
- PC-FILE+ V2 Popular Database with mallmerge, 3 DISCS
- PC-FILE-dB dBase power at shareware prices (HD) 3 DISCS
- FILE EXPRESS Easy to use database, 2 DISCS
- INSTANT RECALL Memory-resident database
- 3X5 CARD INDEX simulate manual system (limited sort)
- DREAM Amazing relational database system, 3 DISCS
- WAMPUM Popular, powerful implementation of the dBASE III database programming language (HD) 2 DISCS

FINANCE

- FREEWAY CASHBOOK UK home accounts & budget, 3 DISCS
- FAST BUCKS Comprehensive home accounts & budget, 2 DISCS
- HOME INVENTORY/HOME INSURANCE with report generator
- HOME LOAN Calculate interest, repayments, reports
- FREEWAY PAYROLL Latest up-to-date version, 3 DISCS
- FREEWAY ACCOUNTS PLUS Popular UK Package complete with Purchase, Sales & Nominal Ledgers, 3 DISCS
- MR BILL Customer billing and tracking, 2 DISCS
- TIME & MONEY Financial tracking with cash projection

APPLICATIONS

- LABEL MAKER Simple mailing label database & printing
- PC MAIL Mailing list system and label printer, 2 DISCS
- 100 STANDARD BUSINESS LETTERS to use and adapt
- EZ FORMS standard forms to edit and use
- BUSINESS GRAPHICS Line, Bar Graphs, Pie Charts, 2 DISCS
- STOCK CONTROL SYSTEM Powerful aid to any business
- AUTOMATED PLANNING Useful suite of planning aids
- PROJECT MANAGEMENT Critical Path Analysis, Gantt Charts
- THE FRONT OFFICE Sales tracking system, 2 DISCS
- BUSINESS CONTACTS MANAGER Multi-function suite, 3 DISCS
- ESIE Expert Sytem Shell, Artificial intelligence
- PRO-COMM Menu-driven communications, 2 DISCS
- PC-DIAL Buttonware communications program
- EZ-UNK UK program with full Prestel/Viewdata, 2 DISCS
- WILDCAT Complete Bulletin Board system, 3 DISCS
- STD CODES IN NUMERICAL order with corresp exchanges
- DESK COMMANDO Menu System, DOS shell, Text Editor, Scientific Calculator, Calendar, Appointments Diary
- PC-DESKTEAM Handy calculator, notepak, diary, DOS access
- HOMEBASE Shareware Sidekick, Calculator, WP, Database, Calendar, Notepad, Communications, DOS access, 3 DISCS

EDUCATION

- AMANDA'S LETTER LOTTO (Age 2-4) Teaches keyboard and letter recognition and co-ordination
- ABC FUNKEYS (Age 2-5) Colourful way to learn letters
- AMY'S FIRST PRIMER (Age 3-6) Six games teaching basic letter and arithmetic skills
- CHILDREN'S GAMES (Age 5-8) Five educational games: Alphabet, Animals, Clockgame, Hangman and Mosaic
- EDUCATIONAL SELECTION (Age 6-10) Hangman (word guessing), Funnels and Buckets (arithmetic), Polyglot (word matching) and Children's Word Processor
- ANDY'S WORD GAMES Opposites, Word Find, Jobs, Synonyms, Odd Word Out, Categories, Comparisons, Plurals, Verbs (Age 6 up)
- TED'S COMPENDIUM A variety of puzzles, anagrams etc
- PHRAZE CRAZE Learn word and phrase skills (Age 7-12)
- JOTTO Like Master mind only based on words not numbers
- WIZ QUIZ (Age 6-12) Quiz based maths tutorial
- MATHS TUTOR (6-Adult) Covers basic to advanced maths
- PC-TUTOR Well presented course on computers & DOS
- HELPDOS All you need to know about DOS
- FASTYPE Popular multi-option PC typing course
- GCSE PHYSICS REVISION Novel way to learn Physics
- GCSE COMPUTER SCIENCE REVISION Novel way to learn
- STATISTICS Over 20 stat analysis functions, 3 DISCS
- NIGHTSKY The latest computer planetarium, 2 DISCS
- TEST & TRAIN Build your own training program
- Foreign languages each on a single disc: FRENCH TUTOR, GERMAN TUTOR, ITALIAN TUTOR, SPANISH TUTOR

GAMES COMPENDIUMS

Advantage have collected many quality games, grouped by style, under various titles. Most games offer graphics and sound with a choice of keyboard or joystick gameplay.

- CLASSIC GAMES - Space Invaders, Pacman, Pacgirl, Ribit, Breakout, Donkey Kong O-Bert, Jumping Joe
- FUN & GAMES - Pango, Baby, Elevator, Centipede, Pyramid, Dragons, Pac, Osbit
- COME IN PEACE - Striker, Paratrooper, Round 42, Sopwith, Landmine, Hostages
- STAR WARRIORS - Quantoids, Rescue, Flightmare, Kamakaze, Space Wars, Emergency Mission
- KEEP THEM AMUSED Burger Blaster, Grime, Racer, Ninja, Caverns and Galaxy
- FACE THE ACTION Batalia, Tank, Moonbase, Blortill, Gemini
- BLOCK & TACKLE Nernon, Oix Xonix, Blockade, Lazer, Berzerk
- GOOD SPORTS PC Tennis, Feed Off (Golf), Yachting in the Bermuda Triangle, Armchair Quarterback (Football)
- SEEK & DESTROY Galactic Conquest, Daleks, Depth Charge, Lazy Monday, Intercept
- SPY CATCHER Master Spy, Brimstone, Mad scientist, Raider
- LOST VEGAS One Arm Bandit, Roulette, Backgammon, Wheel of Fortune and Blorhythms
- SKILL & STRATEGY Frigate, Stock Exchange, Big Rig
- WIT YOUR PITS Brainstorm, battleships, 5-in-a-line, Rogue
- MAZING GAMES Treasure Hunt, Polymaze, Amaze, 3-Demon, Castle, Chase
- PC CHALLENGE Chess, Othello, Entrap, PCGolf, Hexplode, Air Traffic Controller
- JUNIOR CHALLENGE 3D TicTatTo, Dotto, Willy The Worm, Labbits & Voldrons, Draughts, MasterMind

Join the Advantage Independent Computer User Group and choose ANY Shareware discs for just £2 each (3.5" format £3 each)

- * PLUS * £2 off each commercial compiler and toolbox package
- * PLUS * monthly newsletters
- * PLUS * technical support

Annual Membership is £15 (EC Countries) £18 (non-EC countries)

SPECIAL INTEREST

- FAMILY HISTORY Reckoned to be best on genealogy, 2
- FAMILY TIES Easy to use Menu-driven Genealogy program
- WEIGHTWATCHER calorie charts, diet and weight planning
- ASTROL-95 Plot astrological charts and horoscopes, 2 DISCS
- BIORHYTHM MONTHLY Comprehensive plotter and printer
- VCR DATABASE for cataloguing videos, LPs etc.
- MICRO MENU Recipe system offers many useful recipes
- MATCH MAKER Now you can start your own dating agency!
- PC SPORT Useful league table generator
- WORLD Extensive gazetteer of places in the World
- CROSSWORD CREATOR all you need to make your own puzzles
- CROSSWORD SOLVER and anagram generator with dictionary
- COMPOSER Create, play and save tunes using on-screen staff
- PIANOMAN Turn your PC keyboard into a musical one
- BIBLE READER Compressed down with easy reader, 5 DISCS
- THE ENTIRE KING JAMES BIBLE in ASCII text, 11 DISCS

PROGRAMMING

- BASIC INTERPRETER Write and run standard GWBASIC
- PASCAL COMPILER A good introduction to Pascal
- MYSTIC PASCAL compiler and editor
- MODULA-2 COMPILER with editor and linker, 3 DISCS
- PROLOG The language for artificial intelligence
- LADYBUG LOGO Ideal for teaching programming
- BASIC TUTOR Introductory tutorial on BASIC
- GETTING STARTED ON C Introductory lessons and examples
- GETTING STARTED ON ASSEMBLER Useful introduction
- C AND TURBO C TUTOR with source code examples
- CHASM Machine code assembler for the 8086 with Primer
- AB6/D86 Powerful 8086 Assembler with debugger, 2 DISCS

ADVENTURES

- GOLDEN WOMBAT OF DESTINY Intriguing and unusual adventure
- JACARANDA JIM Offbeat and amusing UK adventure
- HACK (Amulet Of Yendor), Extensive role-playing adventure
- DUNGEONS & DRAGONS Fantasy role-playing adventure
- COLOSSAL CAVE ADVENTURE The one that started it
- CAVE QUEST sent to Earth to seek fame and fortune
- SUPERNOVA Complex game set in deep space
- INTERCEPT & MUTANT INVASION Two Sci-fi adventures
- DARK CONTINENT & NEBULA Two games by same author
- QUEST FOR KUKULKAN and UNDER THE ICE Two games

DISC ORGANISATION

- POWER MENU Design Bag's easy to use hard disc menu system
- AUTO MENU Design your own menu for your hard disc
- STILL RIVER SHELL Better front-end than the DOS prompt
- DBS KAT Cataloguing system for hard disc
- DISKCAT Cataloguing system for flopping discs
- DISK COMMANDO Norton utilities at Shareware prices
- ULTRA UTILITIES 'Disc Doctor' with directory of erased files, unerase, sector and file editor
- PROFESSIONAL MASTER KEY New version of this powerful sector and file editor for hard or floppy disc
- PACKDISC Eliminates file fragmentation, economise & speed up your hard disc system
- ARCHIVE SYSTEM Save up to half your back-up discs
- HYPERHELL Menu text presentation and management system
- FLU SHOT Helps you deal with and avoid viruses

UTILITIES UNLIMITED

- ESSENTIAL UTILITIES Over 50 of the best available
- ADVANCED UTILITIES More specialised collection
- USEFUL UTILITIES A further set of over 30 programs
- BAKERS DOZEN Thirteen useful programs from Buttonware
- TEXT PROCESSING Printer Control, Spooler, Print Side-ways, Tally Word Counter, Filters, Fogfinder, Lister
- LASER PRINTER UTILITIES & FONTS, 3 DISCS
- LO Different printer fonts to enhance your Wp text
- FONTASTIC Introduction to DTP with font editor, 2 DISCS
- SIGNSMITH Create your own posters and letter heads

BOARD & CARD GAMES

- SCRABBLE Good implementation of the board game
- SLEUTH Exciting murder mystery solving game
- WORLD DOMINATION The classic game of risk and strategy
- PC-OPOLY Computer version of the well-known board game
- CHESS & CHECKERS Good quality full screen graphic versions
- CHINESE CHECKERS Unusual 6-sided version of draughts
- GAMBLERS DEN Three games - 21, Poker and Pontoon
- BLACKJACK features excellent card pictures and game play
- PUB GAMES Dominoes and Cribbage
- PATIENCE APLENTY 3 games - Solitaire, Pyramid and Sol
- CARD SCHOOL 3 games - Canasta, Gin Rummy & Heart
- MAH-JONG A fascinating taste of the Far East
- TWO BRIDGES Two versions of the card game
- QUIMBEE (YAHTZEE) and FIVE, Two dice-based games

PROJECTS & PASTIMES

- WHEEL OF MISFORTUNE Based on the TV word-guessing game
- OPUS 1 Extensive general knowledge quiz
- TRIVIA QUIZ Many questions, 5 categories, 2 DISCS
- TREK TRIVIA Fascinating quiz based on famous TV series
- BIBLE QUIZ Quiz game based on the Holy Bible
- MUSIC TRIVIA Quiz based on musical questions
- GET LUCKY Adult trivia Quiz and strip poker games
- ADULT HUMOUR Large collection of rather rude jokes
- GAME OF LIFE Fascinating animated graphics game
- PC JOKES A set of funny but harmless practical jokes
- ORIGAMI Study paper folding (needs BASIC Interpreter)
- GREETINGWARE DIY computer greeting cards with demos
- SHOWING OFF YOUR EGA Demo screens, animated patterns
- MANDELROT MAGIC Graphic demonstration and designer
- POPSTAR First in a series of unusual UK games
- SNARF High quality EGA game plus EGA Breakout
- TANK BATTLES A two-player challenge
- STAR TREK II The next generation featuring Morning Cloud
- STAR TREK The original classic game, text & graphics
- PINBALL WIZARD A choice of five different pintables
- PINBALL FANATIC Five more different pintables

ADVANTAGE () 56 BATH ROAD CHELTENHAM GL53 7JH TEL: 0242 224340

FORCES FOILED BY "HACKPROOF" PC

POLICE AND ARMY computer experts have verified that the new Opus Datasafe PC is probably the most secure machine on which anybody could store their precious data.

The newly launched micro is a standard 12MHz 80286 based IBM PC AT clone with a subtle difference – it has two 60Mb hard disc drives that automatically shadow each other's activities, giving the user an automatic back-up of all data. In addition, a complex security password system reminiscent of those used on mainframes is utilised to keep out hackers and viruses.

West country police who tested the system said: "Short of putting the machine in a high standard safe, there is little more that can be done to prevent access."

And technicians in the Army added: "When trying to break into the machine it managed to foil every attempt."

On top of the password and back-up routines, the Datasafe also had a high security lock which prevents the machine being booted from the floppy drive – drastically reducing the chances of picking up a virus. Passwords are required at every level of system access – not merely for logging on, making the machine a good bet as a network file server.

The use of dual hard drives means



● Proud: Opus marketing director Martin Breffitt.

the Datasafe PC has a blistering disc access time: up to five times the speed of the Compaq Deskpro 386 and four times that of the IBM PS/2 Model 80. Because the drive head nearest a given data track at any one time can access the data, the seek time is

reduced from 28ms to 18ms.

Prices are set at £1,700 for a mono version and £2,600 for VGA. Sources suggest that the Opus micros could soon be on sale in Dixons, but this was unconfirmed as PCW went to press.

QUANTEL PATENTS DRAW THE LINE

By Nick Masters

THE WHOLE computer graphics industry has been thrown into turmoil by a high court decision awarding fundamental drawing concepts to one manufacturer.

Quantel effectively now owns exclusive rights to natural freehand drawing on a computer screen using a pressure-sensitive tablet and stylus arrangement, as well as certain stencilling and cut out functions. The case is probably without precedent in the whole computer industry.

Proceedings were instigated about eighteen months ago when rival manufacturers Spaceward Microsystems launched *Matisse*, a paint system that Quantel felt resembled its existing *Paintbox* too closely. Spaceward argued, however, that the concepts of drawing lines on a screen are obvious and therefore cannot be the subject of binding patents. Quantel disagreed and both parties went to the high court to sort the matter out.

Seven weeks of court hearings culminated in a judgement delivered by Hon. Justice Falconer earlier this month upholding Quantel's patents in three of the four issues contested.

Having lost the case Spaceward itself is facing possible bankruptcy in the face of huge court costs and damages awards. An appeal against the order is to be heard on September 29.

The implications for the rest of the industry are not so clear. Speaking after the judgement, Quantel's managing director Richard Taylor stated categorically that it would not licence the paint patents: "Quantel invents to use, not to licence," he said.

Taylor also indicated that other systems which it felt infringed the patents would also be the subject of legal proceedings. So far those named have been limited to the television graphics industry – where *Paintbox* is predominately used.

The nature of the copyright as it now exists, though, could bring Quantel into conflict with just about all computer graphics systems right down to personal computer packages if it felt they were damaging sales of its own products. At present, however, this is a very remote possibility.

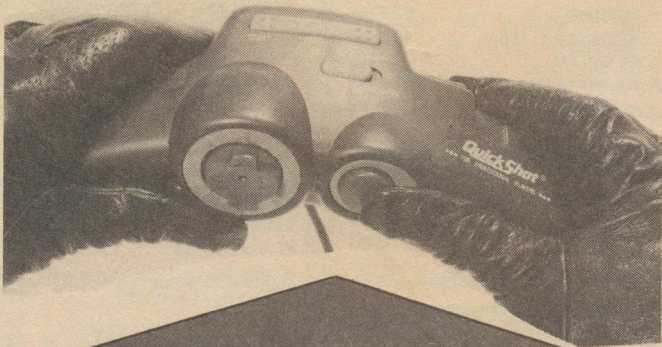

CAN YOU HANDLE IT?

WHEN IS a joystick not a joystick? When it's a "games controller", according to Spectravideo which is launching its *Quickshot QS 129 Flight Controller*.

Spectravideo boss, Ashwin Patel, declared grandiosely: "The new Spectravideo Flight Controller is the first joystick – and I use the word loosely and prefer the phrase game controller – that has been designed for the 1990s."

The gadget is held with both hands, motorbike, handlebar-style, and the cursor control and the fire button are manipulated by the left and right thumb respectively. Presumably if you are left-handed you turn the thing upside-down and change from boy-racer to cow-horn mode.

The Flight Controller sells for £12.50 and a price reduction of 45p has been announced for the company's Quickshot Turbo which is now £10.50. Call Spectravideo on 01 900 0024.

ATTITUDE PROBLEM

BRITISH BUSINESSMEN tend to think of work involving the use of a computer terminal as too menial a task to take up their time, according to a recent study.

These attitudes have been encouraged by advertisements showing male executives standing over secretaries using keyboards, reinforcing the notion that computer work is only for women, claims Istel Inet, an Anglo-Canadian company which surveyed attitudes in 20 companies.

However, bosses in America and Europe have a more enlightened outlook than their equivalents here. Unlike British "keyboard sexists" they see nothing demeaning in using computers.



Octrim Software Limited

Carriage free U.K. Mainland. Please add 15% VAT.

Phone 01-688 0246
 Fax: 01-760 1966
 Telex: 9312102242 OS G
 Open 6 full days a week, Thursday 7 p.m.

COMPUTERS

Amstrad
 PC1512/PC1640/PC2086
 PC2286/PC2386

Epson
 PCe/PCAX/PCAX2
 & portables

Akhter
 PC100/AT1000/AT2000

Zenith
 Supersport portables

Sinclair
 PC200

MOUSE

PC Mouse II Serial	79.95
PC Mouse II Bus	87.95
Supermouse Serial	29.95
Logitech Serial	67.95
Logitech Bus	67.95
Mouse Mat	3.95

ADD ONS

Above Board + 512K	325.00
TAC 1 + Joystick & Card ...	29.95
Maxx Yoke	63.95
PC1512 Memory Expansion ..	35.95
Anti surge plug	9.50
4 way strip	15.95
Enhanced Keyboard PC1512/1640	69.95

COMMUNICATIONS

SM2400 Modem	195.00
MC2400 Modem	145.00
Stradcom V21/22	99.00
WS4000 V21/23	98.00
Linnet V21/23	98.00
Linnet V21/22/23	187.00
Modem Cable (state XT or AT)	12.00
Linkmaster	17.95
CStam	31.95
Laplink Plus	63.95
Chit Chat	69.00
DataTalk	99.00

TAPE DRIVE

Cipher 1525 for Amstrad ...	265.00
-----------------------------	--------

CO-PROCESSORS

8087-2 (for PC1512/1640) ..	99.00
80287-8	175.00
80287-10	195.00

NETWORK

Sage Mainlan Starter Kit	319.95
Add-on Kit	165.00

Amstrad AMS Net

Starter Kit	329.95
Add-on Kit	112.50

HARDCARD

Western Digital 32meg File card	Phone
--	-------

DUST COVERS

PC1512/PC1640 2pcs	7.75
PC2086 12" & 14" mon. 2pcs	7.75
PC2286 12" & 14" mon. 2pcs	7.75
PC2386 12" & 14" mon. 2pcs	7.75
PCW8256/8512 3pcs	8.60
PCW9512 3pcs	8.90
DMP3000/3160/3250	5.25
DMP4000	5.75
LQ3500	5.25
LQ5000	5.75
P1081	5.25
P1124	5.25
LC10/Colour	5.25
LC2410	5.25
LQ500	5.25

RIBBONS

Minimum order 2 ribbons 2+ 5+		
P1081/1082/1090	4.00	3.60
PCW8256/LQ3500	3.75	3.40
DMP3000/3160/3250	2.80	2.50
DMP 4000	4.50	4.20
LX800/FX/RX80	3.15	2.70
FX1000/RX/FX100	4.40	4.10
LQ500/800/850	4.40	4.10
NL10	4.40	4.10
LC10 Black	4.40	4.10
LC2410	4.75	4.40
LC10 Colour	5.50	5.10
NEC P2200	5.75	5.35

FLOPPY DISKS

5.25" DS DD 1 box 5+ 10+		
3M	9.95	8.75 6.95
Precision	6.95	6.40 5.40
3.5" DS DD		
Sony	14.00	13.00 12.00

STATIONERY - SAGE

Statements (1000/1 part)	20.95
Payslips (1000/2 part)	20.95

PRINTERS

Amstrad DMP3250 9 pin narrow	Phone
DMP4000 9 pin wide	199.00
LQ3500 24 pin narrow	260.00
LQ5000 24 pin wide	355.00

Epson FX1050 9 pin wide	420.00
LQ500 24 pin wide	280.00
LQ850 24 pin narrow	461.00
LQ1050 24 pin wide	595.00

NEC P6 Plus 24 pin narrow	450.00
P7 Plus 24 pin wide	575.00

Panasonic KXP1540 24 pin wide	452.00
KXP4450 Laser	1395.00
KXP1124 24 pin narrow	265.00
KXP1180 9 pin narrow	160.00

Star LC10	158.00
LC10 Colour	199.00
LC2410	275.00
FR10 9 pin narrow	325.00
FR15 9 pin narrow	430.00
XB24-10 24 pin narrow	430.00
XB24-15 24 pin narrow	570.00

Cables IBM 1.8 metre	5.00
3 metre	12.00
5 metre	16.00
1.8m cable with printer	3.00
Centronics 2 metre m/m	9.95

Switch Box Parallel 2x1	22.95
---	-------

WORDPROCESSING

WordPerfect V5	* 225.00
Junior	60.00
Wordstar Pro 5	† 215.00
Wordstar Express	Phone
Wordstar 2000	† 250.00
Protect 4	† 55.00
Tasword	† 31.95
Taspell	† 25.75
Tasprint	† 25.75
Sprint	135.00
Topcopy Plus	* 69.00

DATABASE

dBase III +	† 299.00
dBase IV	† 355.00
Paradox V3	399.00
Retrieve III	* 109.00
Retrieve IV	* 199.00
Rapidfile	167.00
Masterfile (std)	† 43.00
Masterfile (full)	* 64.00
Cornerstone	66.00
Smart Data Manager	† 275.00

SPREADSHEET

Supercalc 3.21	Phone
Supercalc 4	Phone
Supercalc 5	* 215.00
Lotus 123	† 269.00
Hal	82.00
Metro	52.00
VP Planner Plus	Phone
Quattro	† 129.00
Logistix	59.00
Plan Perfect	† 195.00

PRODUCTIVITY

Big Plan	Phone
Autoroute	† 99.00
Autoroute Plus	† 199.00
Postcodes	149.00
Gazeteer	109.95
Optimise & Costing	149.00
Stock Market	† 24.00
Microsoft Project	* 232.00
Lotus Agenda	* 205.00

GRAPHICS

VP Graphics	† 66.00
Harvard Graphics	* 280.00
Graphwriter II	† 270.00
Freelance Plus	† 265.00

PRINTING

Easylabeller	21.95
Superlabeller	35.95
with bar codes	66.95

LEISURE

Bridge Player 2000	† 14.50
Crazy Cars	† 14.50
Cyrus II Chess	14.50
F16 Falcon	* 20.95
Falcon AT	* 29.95
F19 Stealth Fighter	† 26.95
Flight Simulator	† 33.00
Football Manager II	14.50
Mean 18 Golf	14.50
PC Gold Hits	† 17.50
Psion Chess	17.95
Scrabble de Luxe	17.50
Silent Service	† 17.50
UMS	17.50
Worlds Greatest II	17.50

DESKTOP PUBLISHING

Timeworks	† 75.00
Timeworks Lite	32.00
Tascopy PC	† 25.75
Tassign PC	† 25.75
Typografica Fonts each	19.95
Prime Collection	45.95
Standard Collection	79.95
Logitech Scanman	169.00
Ventura V2	475.00
Finesse II	99.95

ACCOUNTING

Sage Bookkeeper	* 68.00
Accountant	* 104.00
Accountant Plus	* 163.00
Financial Controller	* 259.00
Job Costing	* 149.00
Payroll II	* 99.00
Utilities (each)	* 29.95
MAP Complete	* 245.00
Job Costing	* 68.00
Payroll 3	* 135.00
Cashbook	* 105.00
ABC Version 2	* 119.00
Account Ability	89.00
Money Manager PC	† 29.95

MENU SYSTEMS

WordPerfect Library	* 78.00
WordPerfect Office	* 275.00
Direct Access	24.95
Disco	† 29.95

UTILITY

Top DOS	† 42.00
File Rescue Plus	* 16.95
Xtree	* 32.95
Xtree Pro	* 75.00
Norton Advanced	* 69.00
Lotus Megellan	79.95

TUTORIAL

Sage Touch Type	19.95
PC Starter	19.95
PC Accounting	19.95
lansyst 2 Finger Type	19.50
Crash Type	19.50

DEVELOPMENT

Turbo C V2	† 69.95
Turbo Pascal V5	† 69.95
Turbo Prolog V2	† 69.95
Toolboxes (each)	† 42.00
Quick C	† 63.00
Quick Basic	† 63.00
M/soft Macro Assemb.	† 82.00
Zortech C++	† 71.95

CAD

Turbo CAD	† 62.00
Autosketch	† 52.00
Generic CAD No. 1	39.95
No. 2	* 75.00
No. 3	* 149.95

INTEGRATED

Ability Plus	* 115.00
Symphony	† 365.00
Microsoft Works	* 105.00
Logotron 8 in 1	* 29.95
Mini Office Personal	† 19.95
Mini Office Pro	† 26.95
Smart System	† 385.00
Secretary Bird	* 29.95

* Supplied on 5¼" and 3½" in same package. † Available on 3½" or 5¼" disk. Prices subject to change without notice. All items offered subject to availability.

Visit our Computer Centre at

30 Croham Road, South Croydon CR2 7BA



tateside

by Steve Gold

complete with fitting instructions, for \$80. Also available are a wide variety of hard disc and removable hard disc cartridge systems for the ST. Prices start at \$799 for a 44MB hard disc cartridge system, complete with 5.25 inch floppy drive, which all fits in a unit that sits underneath the ST monitor. Contact: Toad Computers, PO Box 1315, Severna Park, MD 21146, United States - tel: 0101 301 5446943 for the store.

makes the Ram board much less than most ST expansion cards available in the UK. Contact: Canoe Computer Services, 11006-115 Street, Edmonton AB T5P-2N3 - tel: 0101403 437 4619.

BAZZA'S RAM

* Barry Orlando is offering a series of special instruction files on how to complete a 2.5Mb DIY Ram board for your ST. The file is available free of charge from Barry on a \$15 shareware basis. This means that, if you decide to go ahead and complete the project, saving yourself several hundred pounds in the process, Barry requests a shareware registration of just \$15.00!

For your \$15 you get a disc with the instruction files, utility files to test the system as you install it, plus colour prints of the completed project. Barry can also advise on where to obtain all the various components. Barry can be contacted at: 1120 Deerfield Drive, Napa, CA 94558, USA.

ST GOES HYPER

* Omnicard, an Apple Hypercard workalike package for the Atari ST, which was originally developed by Berrybit, but was shelved last year when the company went bust, may yet see the light of day. Michtron has taken over the project, and has employed several of Berrybit's staff.

Michtron is not officially saying anything about the project, but sources suggest that Omnicard will be released at Comdex Fall in the US this November. Like Hypercard, Omnicard is designed as an integrated package, with a mini-desktop opening screen, where icons represent the various facilities available.

Omnicard reportedly goes several steps beyond Apple's Hypercard in that it uses artificial intelligence (AI) techniques to step the user through the package's features, which include word processing, database and paint modules.

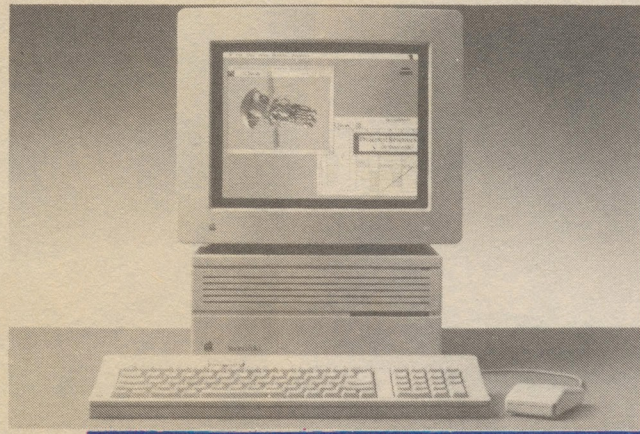

★ The ST could bruise Apple with an Omnicard launch.

during its execution. Then, once the program is reloaded, it returns to the point where it left off.

"The Good Back-Up" utility also allows for dual-security saves, that is, backing up two sets of floppies for maximum security. The package's price will, says TSE, be increased "substantially" later this year. In the meantime, the software can be had for just \$29.95. Contact: Tidbit Software Engineering Company, 25 Wood Lane, Maynard, MA 01754, United States - tel: 0101 508 8977429.

GETTING YOUR ST BACK UP

* Tidbit Software Engineering (TSE) has released a \$29.95 hard disc back-up utility for the ST that the company claims beats all the competition. Looking through "The Good Back-Up" utility's specifications, they might just be right.

Unlike many HD back-up programs, TSE's utility allows incremental - and interruptible - saves to floppy from the hard disc. Put simply, this means that the package can be run on a continuous day-to-day basis, and can be interrupted at any time

TOAD OUT OF ITS HOLE

* Toad Computers has rolled out its Autumn '89 catalogue with the bold claim that it now services international clients (like you and me) with ease. Amongst the many goodies in the catalogue are mail-order packs of TOS 4.1 chips for the Atari ST,



▼ Atari hosting some "Good Back-ups".

PADDLING WITH FRANKENSTEIN

* Canoe Computer Systems has developed a Ram upgrade for all models in the Atari ST console series. The FrankenSTein Ram board plugs into any 520 or 1040 series ST, boosting Ram to 2 or 4Mb as required.

FrankenSTein is available in several configurations, ranging from a 0K board (you supply the chips) at \$149.95, to 2Mb at \$439.95, to 4Mb at \$689.95. Canoe is only asking for \$4.50 postage and packing, which

FAST MODULE

* Pro-VME, a new West German company on the ST scene, has released Hypercache ST, a hardware module for all models in the Atari ST family that increases computing speeds by around 70 percent. The 517Dm system is fully compatible with all Atari ST software, including GEM/TOS, OS-9, Calamus, Megamax-C, Prospero Fortran, and other "difficult" packages.

The module features a 16-MHz 68000 microprocessor and an 8K-byte instruction/data cache, which can be switched on or off using software. The microprocessor maintains the 16-MHz speed and emulates the original 8-MHz microprocessor protocol.

Installing Hypercache ST is simply a matter of unplugging the original ST's microprocessor and slotting in the new board, and then connecting two wires - one to feed the microprocessor and the other activates the signal for the software on/off switch.

Interested in this unusual card? If so, contact: Pro-VME, PO Box 1236, D-6903 Neckargemund 1, West Germany - Tel: 010 49 622 372 029.

POPULAR COMMENT

You can always expect the unexpected from Commodore. This week's announcement of a new software bundling deal with their Amiga 500 is quite a corker. Rather than giving away games gathering dust in some software house's warehouse, Commodore are giving away a package of three games which includes the as yet unreleased *Batman The Movie* game on the Amiga from Ocean. For only £399.99, the Batman Pack is an essential buy.

How interesting therefore is the issue of how the film industry and computers are linking together. Check out Computers in the movies on page 20 for the low-down.

Well, here we are at the PC Show 1989. It seems like yesterday when *Pop* was last at the show. As you may have gathered, *Pop* has undergone a bit of an uplift. We've introduced a snazzy new logo and undergone a new layout style. We hope this enhances your reading enjoyment of *Pop*. Why not pay us a visit at stand 2319 at the Show.

YOUR CONTACTS

01-834 1717

Editor Paul Marks
Deputy Editor Michael Johnson
Production Editor Dominique Coughlin
Design Department Paul Ellis, Adrian Hulf
Contributors: Technology: Kenn Garroch.
Music/MIDI: Tony Sacks. Comms: Steve Gold, Malcolm Arnold. DTP: Tony Hetherington.
Simulators: Lee Paddon. Arcades: John Cook.
Adventure: Tony Bridge, Ken Matthews.
Advertising Manager William Saville
Asst. Ad. Manager Andrew McAngus
Classified Executive Tony Pelham
Publisher Perry Trevers
Group Editor Carlo Jolly

Managing Director Peter Welham
Financial Director Brendan McGrath
Chief Executive Richard Hease
Popular Computing Weekly, Greencoat House, Francis Street, London SW1P 1DG. Telephone 01-834 1717. FAX 01-630 6165.

© PCW 1989. ISSN 0265-0509.

Typeset by Hamilton Press. Printed by Southern Print. Distributed by SM Distribution, Streatham, London SW16. Telephone 01-677 8111. Subscription rates: UK £38.25, Europe £47.40, Middle East £58.10, Far East £55.10, U.S.A. \$86.00, Rest of world £49.50. Phone SM for airmail charges.



NOW YOUR ATARI STF/STFM
CAN TRAVEL WITH YOU
MORE COMFORTABLY
IN THIS PORTFOLIO

This bag can also accommodate the Amiga A500 minus the p.s.u.

It's durable. It's lightweight. And it's waterproof.
The bag will retain its shape even when it is empty.
The handles are strong and being reinforced with metallic square rings for flexibility.
To minimise wear and tear all edges are protected with p.u. material.

SPECIFICATION:

Materials: Nylon Oxford
Size: 510mm x 358mm x 80mm
Colour: Black
Zip: Black, durable and non-rusting
Style: Artist's portfolio design
Side pocket: One on the inside for magazines and manuals

Mail order
Send Cheques or P.O.'s for £25.00 (incl P&P)
payable to Omni-Top to:

Omni-Top

27 Coxwell Close,
Linden Village,
Buckingham,
MK 18 7BE.

Falcon about

I've a big problem with *Falcon Mission* disc one on my Atari 520 STFM.

When I load it and am prompted to load disc 2, the disc drive just keeps on working and does not allow me to change discs.

I wrote to Mirrorsoft (August 9) and there was no reply. So instead I phoned them (twice). The first time I was told I should "click" on the QUIT option to stop the drive working – but there is no such choice on the loading screen!

On my second call to Mirrorsoft, I was told to simply take the disc out. But doesn't removing the disc when the "disc busy" light is on damage it?

As I have had this program for well over a month now and have been unable to use it (a waste of £20), I wondered if you could help me, as Mirrorsoft don't seem bothered with after sales service.

When *F-16 Combat Pilot* went wrong (with a similar problem) Digital Integration solved my problem – by replacing my discs – in less than a week. If only Mirrorsoft could follow their example.

J. E. Rollitt, Brinsworth, Rotherham

This must be a common problem because Mirrorsoft told us: "The advice you've been given is wrong. The standard line on this problem is to switch the write protect tag on the second disc so that it can't be written to. If that fails, just send us the discs back and we'll replace them."

Since your problem manifests itself before you get to the second disc, you probably need to replace the software. Mirrorsoft is at Irwin House, 118 Southwark St, London SE1 0SW. Tel: 01-928 1454.

Sold down the Rivaz

Thank you for publishing my article *The Limits of Miniaturisation* in your Feedback section. However the last sentence was garbled by your printers. The paragraph was discussing the cost of programs that would be run on nanocomputers of the future, in relation to the cost of the nanocomputers.

In the copy I sent you the last sentence read: *It is likely that the hardware upon which they will run will probably have about the same relationship to their cost as does the paper wrapper of a computer disc to the price of the program recorded on the disc today.*

John de Rivaz, Truro, Cornwall

Sorry about the cock-up – I think we got the gist of it, though.

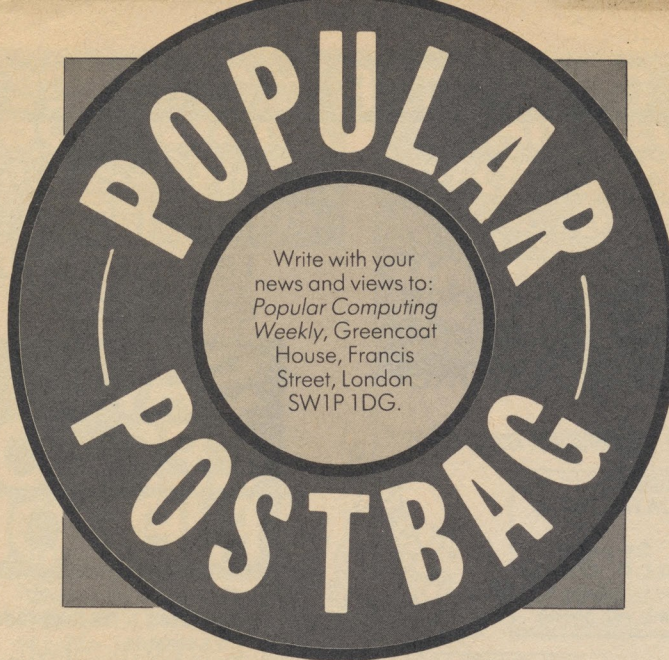

Dealer row

I am writing about the difference between UK and USA prices on computer hardware. As an ex-dealer who has imported some equipment from the USA, I find the advert for an Amiga hard drive system unbelievable. The US price is \$599. This is turned into a UK price of £600! This is blatant overpricing, at the current exchange rate of \$1.55=£1.00, and allowing for trade discount on the advertised US price, import duty (6% at present) and VAT etc. These drives are being sold at a mark up in excess of 50%, obviously a case not of what is the product worth, but a case of what will the market bear?

That pricing structure may be acceptable to some, but surely when such generous margins are in operation, then some money could be spent on proper advertising and not simply cut and pasting the American advert!

Nigel J. Carron, Redruth, Cornwall
PS. I of course wonder whether a letter attacking a full page advertiser would appear.

Danny Smith, at Micron Computer Centre, replies:

I feel rather smug after reading Mr Nigel Carron's letter. Yes I think that anyone trying to sell a product for £600 when it retails for \$599 in the States, is being greedy. The product on offer at \$599 is a 20meg non autobooting hard drive, however, with a 60 millisecond access time and has no 2 meg ram board.

The product is advertised by ourselves is a 40 meg autobooting drive with an unpopulated 2meg RAM board and an incredible 11 millisecond access time. This product retails at \$1099-00 in the States. Add to this 15% VAT and then 9% import duty and I end up with a figure of £888.77 plus delivery and insurance. Anyone who prefers to pay for our unit based on Mr Carrons calculations should call us on 0206 769398!



Making an exhibition

Yes, I do have a view about the possibility of Atari UK no longer taking space at the 1990 PC Show. My reaction is one of disappointment.

The PC Show site is easily reached by coach from my neck of the woods. The same transport convenience applies to the Novotel exhibition centre, but I am not too keen on the North London exhibition sites.

I have also been to the Which Computer Show in Birmingham these last two years, where the attraction is plenty of free car parks. But the PC Show is probably the more exciting and varied, with its leisure section to brighten up the visit.

P. Michael Kingston, Littledean, Bristol.

Your letter is typical of the responses we have had so far. Atari is known for leaking the odd bit of disinformation to keep up interest in the firm's activities, so this could well be just another such diversion. But if the rumours of a Hewlett Packard takeover of Commodore have any substance, the latter may not be there either.

Rocket socket

I would like to enquire as to whether there are any Amiga owners out there who are interested in the following subjects: Model Rocketry, Robotics (if the ST can do it, I'm sure the Amiga can!), Basic Programming (pertaining to the above, or utilities etc.), Applications of any kind other than the usual games, WP, etc.

I would very much like to hear from them (if indeed they exist!), and would greatly appreciate it if they could write to me, detailing their use of the machine. Let's face it, if there's no application, there's no need for a machine!

Before signing off, I'd like to know if there is any possible means of using an old 128k "Specy" as a printer buffer between the Amiga and my printer (Star LC10-Colour). Cheers!

Dave Evans, 109 Trinity Avenue, Llandudno, Gwynedd LL30 2UJ

Kenn Garroch will answer your techie problem in a future issue. In the meantime tell us what wacky applications you come across.

Bingo call

In the August/September issue of PCW, I was interested to see Steven Foster's solution to the "bingo number caller" problem.

Although elegant, he misses the point. Like many card games, the key to the problem is that you do not need to create a random set of numbers, rather you need to randomly shuffle a known range of numbers.

The routines shown below do this for the BBC machines. The BBC random number generator is slightly different to other machines in that it can directly create integers, so the routines will need some modification to be applicable to others.

```
10 DIM A(90)
20 REM Fill number array
30 FOR I=1 TO 90
40 A(I)=I
50 NEXT
60 REM shuffle numbers
70 FOR I=1 TO 90
80 R=RND(90)
90 T=A(R)
100 A(R)=A(I)
110 A(I)=T
120 NEXT
```

Numbers can now be picked, pack of cards style, by reading linearly through the array.

Astute observers will have seen that the shuffling process will allow some array elements to be swapped with themselves.

The likelihood of this happening is remote, but still doesn't invalidate the randomness.

Statistically there is no reason why the 9th number called can't be number 9.

Terry Blunt, Crowthorne, Berks.

RIBBONS

Amstrad DMP 2/3000 series	2482	A
Amstrad DMP 4000	2426	E
Amstrad PCW8256 (L/Life)	*2741	D
Amstrad PCW9512	*2746	B
Brother HR15/25/40	*2696	B
Canon PW1080A	2223	D
Centronics GLP	2412	D
Citizen 120D/180E/LSP10	2488	B
Citizen MSP-40/50	2477	D
Commodore MPS801	2236	D
Epson FX/LX-80	2273	B
Epson LX/GX-80	2454	B
Epson LQ-500	2477	D
Epson RX-80	2273	B
Epson EX-800	2774	D
Epson Full Width	*320	D
Juki 6100 Daisywheel M/S	2563	B
NEC Pinwriter P1/P2	2254	D
NEC P2200	2844	D
NEC P6+/P7+	2870	E
Panasonic KXP-1081/1180	2228	D
Seikosha GP100	2317	D
Seikosha SL80 (L/Life)	*2741	D
Seikosha 500/550	2236	D
Shirwa CP80/MT80	*2698	D
Tatung/Commodore CP80	2698	D
Star LC10	2861	B
Star LC24-10	2868	B
Star NL10	2761	D

WE ALSO HAVE
DISKS
and a Technical
Library of
1500 BOOKS!

Please enquire!

**FREE SUPPLIES
CATALOGUE**

**24-page
FULL BOOKLIST
50p**
(Only with goods)



PAPER

All prices per 1000 sheets incl. VAT

** P&P £2.50 any quantity*

11/9.5 60gsm Listing	£6.45
11/9.5 70gsm Microperf	£7.95
11/9.5 85gsm Letter Qual	£9.95
A4 size 70gsm Microperf	£9.70
A4 size 85gsm Letter Qual	£10.95
11/9.5 2 part NCR	£19.40
A5 size Letter Quality paper, Upright (Portrait) Orientation, Microperf all edges for letter-writing	£13.90

Address Labels

3.5/1.5, 1- or 2- across

£3.75 per 1000 (+£2.50 P&P)

At last - a *unique*
new ink spray that
restores ribbons in
seconds

**SAVE
£££s ON
RIBBONS**

- Quick & Convenient.
- Restores & Re-inks faded ribbons in seconds!
- Refreshed ribbon lubricates print head for smoother running & enhanced printer life.
- Use on any fabric ribbon... again and again!
- Pays for itself the first two times you use it.



**ONLY
£8.95**
inc VAT & post

Cheques/POs (no stamp needed)
CASPELL COMPUTER SERVICES
Dept. P2 FREEPOST, Poole Dorset BH15 1BR
Tel: 0202 666155 or 0202 35650 (24-hr)
TRADE ENQUIRES & LOCAL AUTHORITY ORDERS WELCOMED
Account enquires: 43 Emerson Rd., Poole Dorset BH15 1QS

Many others - please enquire!
* = Avail. in Fabric Nylon or M/strike Film.
Please choose!

(Fabrics offer longer life and may be used
with Ribbon Refresh!)

PRICE STRUCTURE

	1 off	2 off	5 off
A	£2.95	£5.75	£12.95
B	£3.95	£7.45	£16.95
C	£4.45	£7.95	£18.45
D	£4.95	£8.95	£16.95
E	£5.95	£10.95	£24.95

Prices include VAT & post

Fourth Dimension
computing have
recently launched its
superb joystick at an
excellent starting price.

Call for details

0792 816612

UNIT N, LON LAS, LON LAS WORKSHOPS,
SKEWON, W. GLAMORGAN SA10 6RP

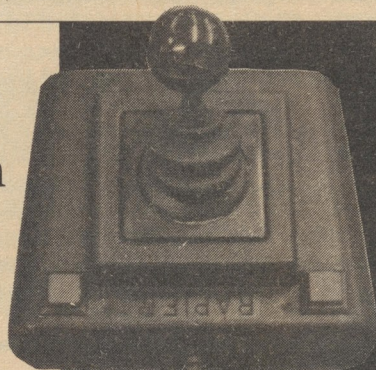

RAPIER

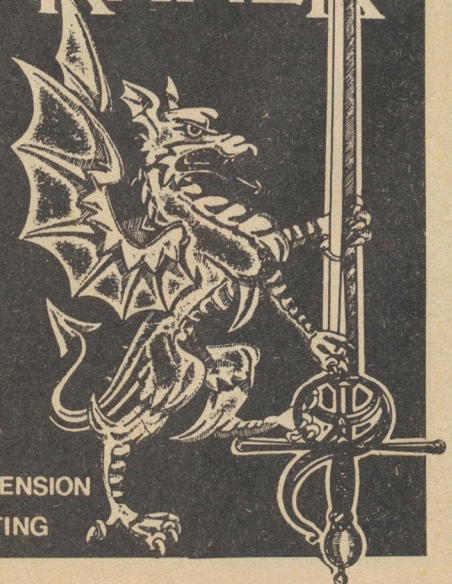

FOURTH DIMENSION
COMPUTING

Since its launch in 1982, the Sinclair ZX Spectrum has been one of the most popular home computers ever. Over its seven years, the Spectrum has been used for many things, accounting, cataloguing and word processing, as well as music, and, very occasionally, audio sampling. But sampling could soon move to the top of users' lists when Pandaal Marketing launch the £39.95 Spectrum *Mastersound* package.

Mastersound has little competition; the only other two sampling packages for the Spectrum do not offer the features of Mastersound. The only drawback of the page is its machine limitations – Mastersound will only work on a Spectrum with 128K RAM. This should not be too much of a problem for most people, however, as many specy users seem to have upgraded anyway.

The package consists of a hardware sampling unit which is housed in a black box with two RCA phono-type sockets showing through a hole cut in the top. The box connects to the Spectrum via an edge connector which is pushed onto the expansion port of the machine. As long as the machine and sampler are on a level surface, the contact between the two will be firm. If the surface is uneven, however, connection could be hampered.

The sample editing software is supplied on either cassette or disc and includes many features which were not available



The Spectrum goes audio sampling with Mastersound. Andrew Banner previews some special effects.

◆ Keeping clear frequencies.

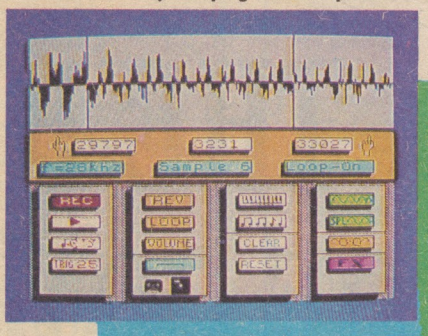

● An opened black box of sampled sound.

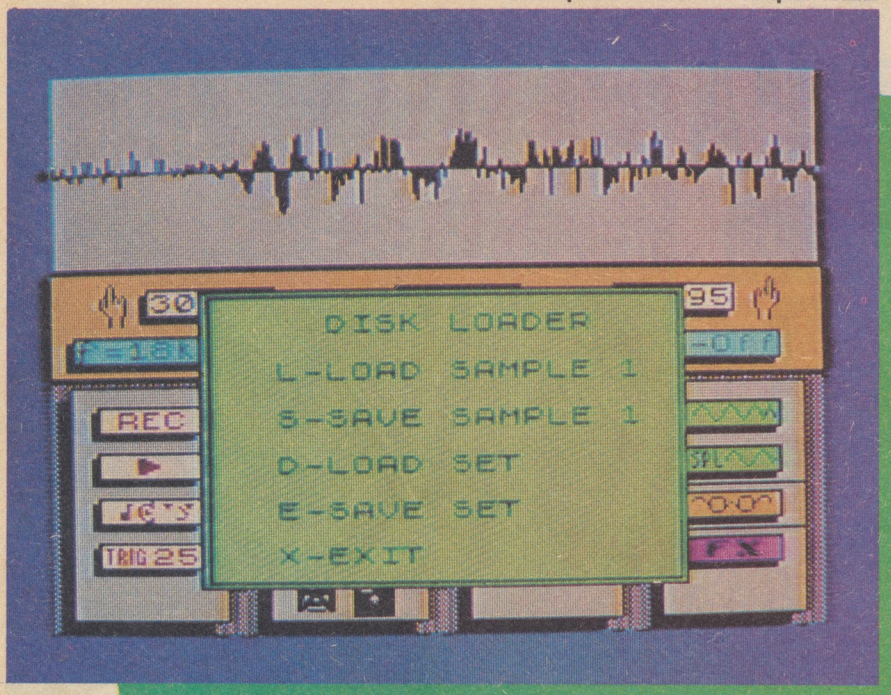

on other Spectrum samplers. Because of the bank-selected memory of the Spectrum 128K, samples are restricted to being just 48K. At 5Khz this would provide about 10 seconds of sample time. However, being limited to 48K allows the computer to store up to 8 samples in memory at one time. These can be trig-

gered from the keyboard and could allow a series of short samples to be linked to produce something considerably longer.

The software user interface is quite reasonable. As with other sampler packages, the top portion of the screen displays the sample in memory as a series of vertical lines of varying length. Below this

are figures relating to the size – in bytes – of the sample and the sample frequency. Further down the screen the editing controls are represented by a series of “buttons”. These are accessed by pressing corresponding keys, and once in use the “buttons” light to show that it is in operation. This method works well, and it does not take long to remember all of the keys. Some functions prompt windows to open over the control area. These contain further program commands which were unavailable on the main selection panel.

Commands like the special effect filters are stored in windows. The package allows the incoming signal to be modified in real time to provide effects such as echoes and pitch shift, as well as providing a “flange” option. The load and save options are also accessed through windows.

■ Live on TV

The sample quality provided by Spectrum Mastersound is quite staggering. It uses sample frequencies between 5Khz and 25Khz, and although at 25Khz the sample is rather short, the quality is unbelievably good. To help get the sample volume correct, the software includes a real-time oscilloscope which displays the incoming signal in the sample window. The hardware also allows the sample output to be channelled through either the television speaker or an external audio amplifier via one of the phono sockets on the plug in module. Spectrum Mastersound should be available by the time you read this. □

C O N T A C T S

Pandaal Marketing
182a Bedford Road
Kempston
Bedford
MK42 8BL
Telephone: 0234 841224

The development of the first completely electronic computers in the mid-1940s and early 1950s started with COLOSSUS and ENIAC and although they were not particularly fast compared to modern computing, they were a good deal faster than any mechanical devices.

In 1948 at Manchester University the first machine was built which stored its data and program in the same place. This may not seem like much but it was a major breakthrough in the technological frontier.

Previously, computers had taken instructions from punched cards or paper tape and were restrained by the input speed of these systems. Punch-card systems had been around since the 1890s when they had been used to sort information for the US census. The theory had been around even longer as punch-card patterns were used in weaving machines and player pianos. As reading machines could produce electrical pulses corresponding to the holes in the cards, they were ideal for feeding programs and data into computers. They remained a popular method of data entry up until a few years ago and are probably still in use in some establishments.

A system that was similar to the punch-card but more convenient and cheaper was paper tape. As with punch-cards, holes were punched into the tape to represent different numbers. This tape was fed into the computer via a tape reader at about 30 characters per second using a mechanical system. Later machines used optical sensors and improved reading speeds tenfold.

◆ Vibrations

Both punch-cards and paper tape were fine for getting information into and out of computers before and after the program had been run. While the computer was running a program, however, intermediate results and program instructions had to be stored so that the computer could get at them quickly and easily – this was the innovation of the first computers designed and built at Manchester University.

The first "fast" memory system was the mercury delay line which stored data as a series of pulses. Pulses and signals of any sort take time to get from one place to another. Normally this is treated as a problem to be solved – but it can also be used to advantage as a storage method. Since mechanical vibrations travel far more slowly than electronic pulses they can be stored in a shorter distance.

A delay line converts electrical pulses into vibrations by means of a piezo electric crystal. The vibrations are then transmitted down a tube of mercury and picked up at the other end by another

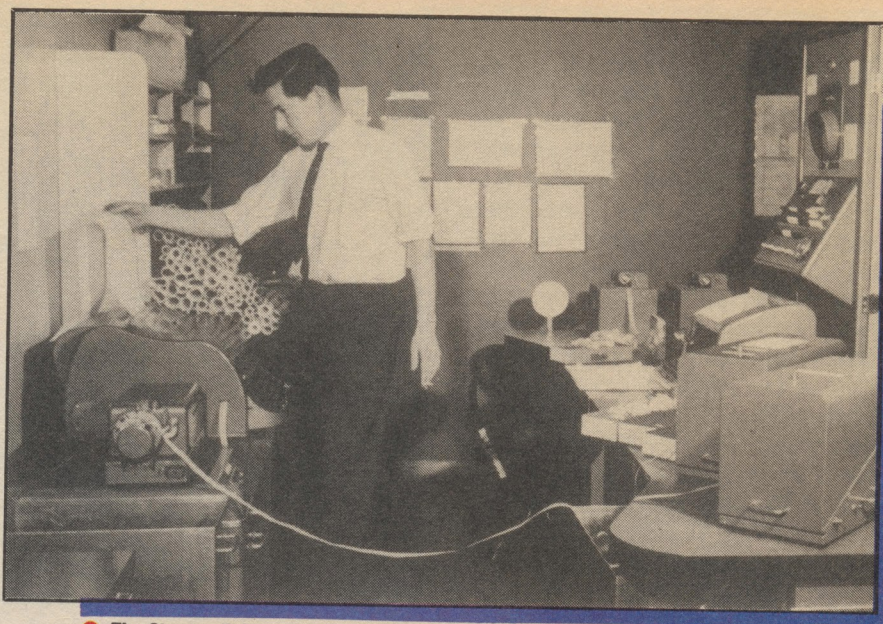

● The Stantec Zebra, a Dutch built general purpose computer.

THE HISTORY OF COMPUTING: PART TWO ...

In the second part of our series, Kenn Garroch hits the halfway mark of the 20th century. Bobby socks, teddy boys, Bill Haley and the COLOSSUS. Read on.

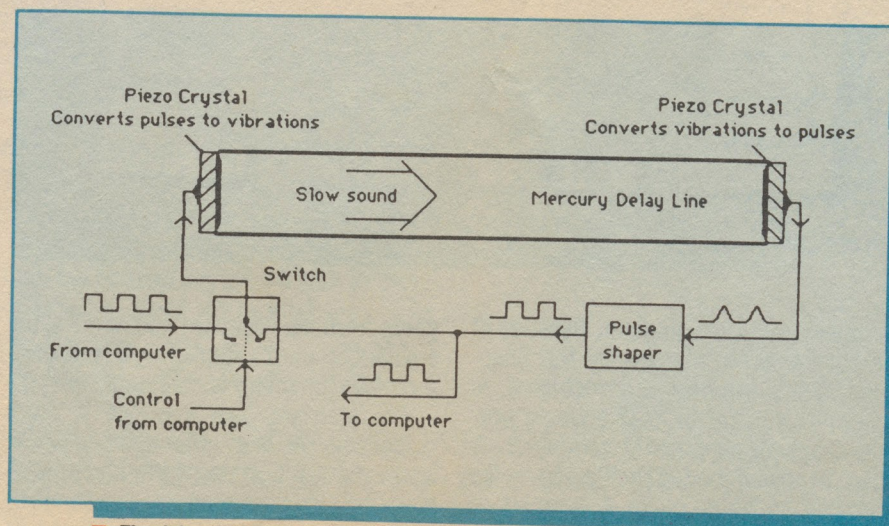

■ The delay line store

piezo crystal and converted back into electrical pulses. To maintain the store, these pulses are then shaped back into squares pulses and fed back into the start of the delay line. It takes about a millisecond for a pulse to travel down the line, so it is stored for that millisecond. In practice, around 1,000 pulses or bits of data can be stored in such a line, one after the other in a serial format. They are fed around and around until the program needs to read them. It can do this by waiting for the correct sequence to start when the pulses are then read. New information can be fed into the line by flipping over a switch at input to accept new pulses instead of the pulses being fed back. The big drawback is that the program has to wait for the pulse to be in the correct position before they can be read.

The EDSAC (Electronic Delay Storage Automatic Calculator) built at Cambridge

early Manchester machines and put on sale in 1951. It was a general purpose computer to be used for scientific programs. The first computer to be used for commercial purposes was LEO (Lyons Electronic Office). This was based on the Cambridge EDSAC and completed in 1951. Its main purpose was to produce the payroll and control stock.

● *Magnetic*

In 1955 both the tube store and the delay line store were superseded by the core store. This provided much more storage in a smaller area than was previously possible and helped to make computers smaller and a lot faster.

The core store uses the ability of a material called ferrite to pick up and hold a magnetic field. The cores are tiny rings with wires running through them – about the size of a full stop. When a current is passed through the wire in one direction,

that used to write its present state, ie, if it were 0 and another 0 were written, there would be little or no effect on the sense wire. If the write current is the opposite to that used, however, to set up the core, it will cause the core to be magnetised in the opposite direction and the reversal of the field will cause a pulse in the sense wire. Defining the appearance of a pulse as a 1 and the write current needed to get this, at 0 a method of reading the core is set up. This is a destructive read since the core state will be changed if it was at 1 – the writing of a 0 is necessary to read the fact that it was 1 – and it must be re-written after reading to make sure that the data is kept until intentionally changed.

All of the above is fine for a single core but to store a lot of information, a number of cores must be used – as shown in the illustration. Two write wires are used, each with half of the required write current, to select a particular core. A single

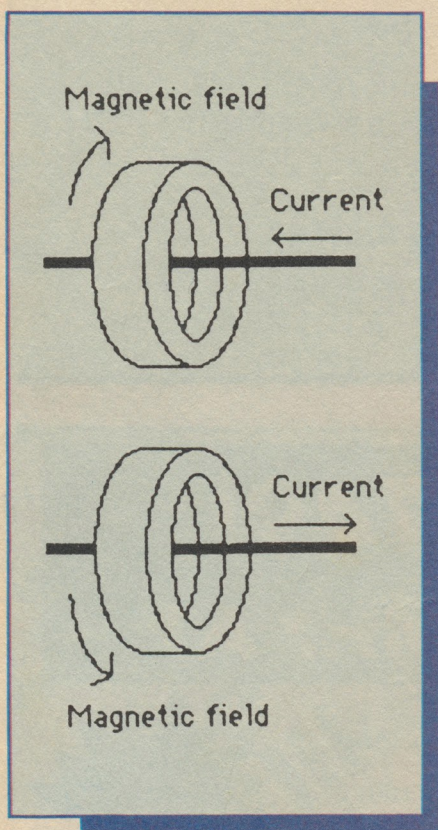

◆ Cores in action.

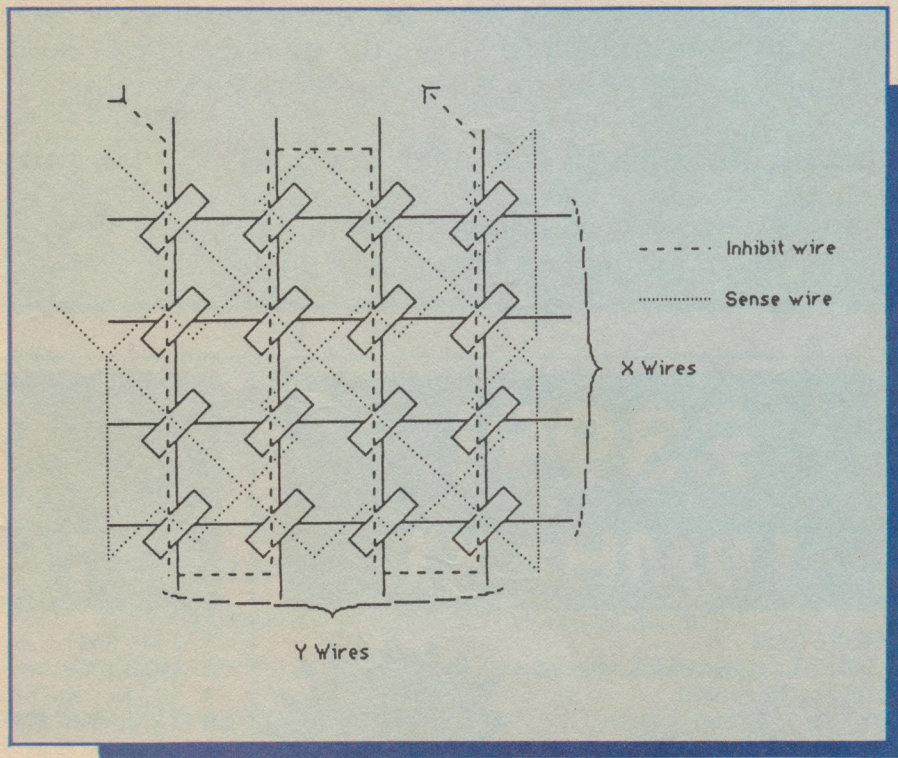

■ Magnetic core store.

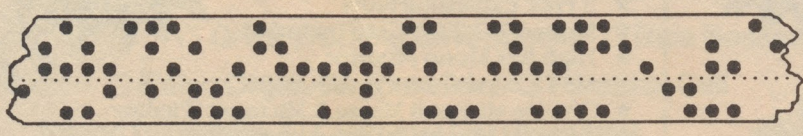

University in 1949 and the National Physical Laboratory's ACE Pilot, built in 1950 used delay line stores. Manchester University developed the more sophisticated Williams Tube store for its next machines. This used a cathode ray tube (CRT) to store words of data. The advantage was that data was stored in words and could be written from any position.

The first commercial computer, the Ferranti Mk1, was developed from the

it sets up a magnetic field in the core which stays when the current is removed. A current in the opposite direction sets up the reverse magnetic field giving the possibility of storing 1 and 0, depending on the direction of the magnetic field. This wire is known as the write wire.

By inserting another wire into the core alongside the write wire, the state of the core can be read. If a current is put through the write wire that is the same as

sense wire can be used because the position of the core being read is known. The core store was faster than any of the previous methods and access times of about 200 nanoseconds are common.

By the mid-1950s, there were a number of companies building and selling computers, all based on the early valve machines developed at Manchester, Cambridge, MIT in the USA – who produced Whirlwind 1 in 1953, and NPL.

In December 1947 at Bell Labs in the USA, the first transistor was built. By the end of the 1950s, it had developed to the stage of being small, reliable, and reasonably cheap. All the new computers were now designed around transistor instead of the thermionic valve. □

PC SHOW COMPETITION HUNT THE TELEPHONE!

Can you recognise a telephone?

British Telecom have installed several devices which look a great deal like telephones around the PC show (see artist's impression). If you are a programmer these 'telephones' are not just telephones – they are portals to *another world!*

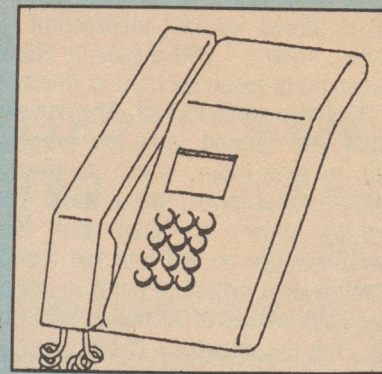

Random access, the development arm of The Sales Curve (responsible for producing such titles as Silkworm, Shinobi, Continental Circus and The Ninja Warriors), are looking for more programmers to join them!

If you are at the PC show you can phone Simon Pick NOW on 370 8255. He will entertain you upstairs away from the hussle and bussle of the show, and give *YOU* the chance to impress him with your work personally.

Hunt the phone and contact Simon NOW to arrange a meeting!

Runner-up prize: If you don't find a phone before October 3 don't worry! Just Phone Simon on 585 3308 instead.

£399!
10MHz XT

- ★ 640Kb RAM
- ★ 10MHz CPU switchable to 4.77
- ★ 102 Key Keyboard
- ★ 360 Kb 5¼" Floppy Drive
- ★ 2 Parallel Ports
- ★ 2 Serial Ports
- ★ Real Time Clock/Calendar
- ★ 5/6 Free Expansion Slots
- ★ Hercules Graphics Card and High Res Mono Monitor
- ★ MS-DOS vers. 3.3 and GW-Basic
- ★ Microsoft Windows
- ★ Full Set of Manuals & Documentation

Single Drive Complete System Mono	£399
40Mb 30Ms Complete System MONO	£599
14" EGA Colour Monitor add	£226
720Kb 3½" Floppy Drive add	£60

**Rated
5 stars
by N.C.E.
Issue 43**

£749!
16MHz AT

- ★ 1 Mb RAM
- ★ 16MHz CPU switchable to 6
- ★ 102 Key Keyboard
- ★ 1.2Mb 5¼" FLOPPY DRIVE
- ★ 1 Parallel Port
- ★ 2 Serial Ports
- ★ Real Time Clock/Calendar
- ★ 5 Free Expansion Slots
- ★ Mono/CGA/EGA Card Included
- ★ High Res Mono Monitor
- ★ MS-DOS vers. 4.01 & GW-BASIC
- ★ Genuine Microsoft Mouse & Microsoft Window
- ★ Full set of Manuals & Documentation
- ★ 1 YEAR ON SITE MAINTENANCE (Base Unit)

Single Drive Complete System Mono	£749
45Mb 25Ms Complete System MONO	£1,025
14" EGA Colour Monitor add	£200
1.44 Mb 3½" Floppy Drive add	£85

**Rated
4 stars
by N.C.E.
Issue 43**

DOLAN ELECTRONICS LTD

DANFFORDDGAR HOUSE,
CARMARTHEN, DYFED
SA32 7DU

SALES: 0267 84538

FAX: 0267 84617



All Prices ex VAT & Delivery
C.W.O., C.O.D. AVAILABLE
(Specification Subject to change)



FREE! TENSTAR PACK WORTH OVER £229!

Commodore AMIGA

 FREE! - AMEGAS - by Players	 FREE! - INSANITY FIGHT - by Microdeal
 FREE! - ART OF CHESS - by SPA	 FREE! - MERCENARY COMP - by Novagen
 FREE! - BARBARIAN, ULT WARRIOR - by Palace	 FREE! - TERRORPODS - by Psygnosis
 FREE! - BUGGY BOY - by Elite	 FREE! - THUNDERCATS - by Elite
 FREE! - IKARI WARRIORS - by Elite	 FREE! - WIZBALL - by Ocean



ONLY £3.34 PER WEEK
RETURN COUPON FOR DETAILS

£346.95

+VAT = **£399**
INCLUDES FREE UK DELIVERY

The Amiga 500 is one of a new breed of technologically advanced computers, which are now emerging as the new standard for home computing, based around the new Motorola 68000 chip. The A500 has 512K RAM and a 1Mbyte double sided disk drive built-in. It can be connected directly to a wide range of monitors, or to a domestic TV set through a TV modulator. Designed with the user in mind, the A500 features a user friendly WIMP environment and comes supplied with a free mouse. And, when you buy your Amiga from Silica Shop, the UK's No1 Amiga specialists, you will experience an after sales service that is second to none, including a technical support helpline and free newsletters and price lists. Return the coupon below for our current information pack, which will give details of the Silica service and the very latest Silica Amiga offers. E&OE.

WHY SILICA SHOP?

Before you decide when to buy your new Commodore Amiga computer, we suggest you consider very carefully WHERE you buy it. There are MANY companies who can offer you a computer, a few peripherals and the top ten selling titles. There are FEWER companies who can offer a wide range of products for your computer as well as expert advice and help when you need it. There is ONLY ONE company who can provide the largest range of Amiga related products in the UK, a full time Amiga specialist technical helpline and in-depth after sales support, including free newsletters and brochures delivered to your door for as long as you require after you purchase your computer. That one company is Silica Shop. We have been established in the home computer field for ten years and can now claim to meet our customers requirements with an accuracy and understanding which is second to none. Here are just some of the things we can offer you.

THE FULL STOCK RANGE: The largest range of Amiga related peripherals, accessories, books and software in the UK.

AFTER SALES SUPPORT: The staff at Silica Shop are dedicated to help you to get the best from your Amiga.

FREE NEWSLETTERS: Mailed direct to your home as soon as we print them, featuring offers and latest releases.

FREE OVERNIGHT DELIVERY: On all hardware orders shipped to Silica Shop customers within the UK mainland.

PRICE MATCH PROMISE: We will normally match our competitors offers on a 'same product same price' basis.

FREE TECHNICAL HELPLINE: Full time team of Amiga technical experts to help you with your technical queries.

But don't just take our word for it. Complete and return the coupon below for our latest Amiga literature and begin to experience the Silica Shop specialist Amiga service.

PHOTON PAINT PACK

A500 Computer	£399.99
TV Modulator	£24.99
Photon Paint	£69.95
TenStar Pack	£229.50
TOTAL RRP:	£724.43
LESS DISCOUNT:	£325.43
PACK PRICE INC VAT:	£399

FREE FROM SILICA

When you buy the Amiga 500 from Silica Shop, you will not only get a high power, value for money computer, we will also give you some spectacular free gifts. First of all, we are now including a TV modulator with every A500 stand alone keyboard, so you can plug your Amiga straight into your TV at home (the modulator is not included with the A500+A1084S pack as it is not required for use with monitors). Secondly, we have added a free copy of Photon Paint, an advanced graphics package with an RRP of £69.95. Last (and by no means least!), so that you can be up and running straight away, we are giving away the sensational TENSTAR GAMES PACK with every A500 purchased at Silica Shop. This pack features ten top Amiga titles which have a combined RRP of nearly £230! Return the coupon for details.

1084S MONITOR PACK

A500 Computer	£399.99
1084S Colour Monitor	£299.99
Photon Paint	£69.95
TenStar Pack	£229.50
TOTAL RRP:	£999.43
LESS DISCOUNT:	£350.43
PACK PRICE INC VAT:	£649

FREE TENSTAR PACK

Amegas	£14.95
Art Of Chess	£24.95
Barbarian, Ult Warrior	£19.95
Buggy Boy	£24.95
Ikari Warriors	£24.95
Insanity Fight	£24.95
Mercenary Comp	£19.95
Terrorpods	£24.95
Thundercats	£24.95
Wizball	£24.95
TOTAL RRP:	£229.50

INC VAT

DO YOU OWN AN AMIGA?

If you already own an Amiga computer and would like to be registered on our mailing list as an Amiga user, let us know. We will be pleased to send you copies of our price lists and newsletters FREE OF CHARGE as they become available. Complete the coupon and return it to our Sidcup branch and begin experiencing a specialist Amiga service that is second to none.

SILICA SHOP:

SIDCUP (& Mail Order) 01-309 1111
1-4 The Mews, Hatherley Road, Sidcup, Kent, DA14 4DX
OPEN: MON-SAT 9am - 5.30pm LATE NIGHT: FRIDAY 9am - 7pm

LONDON 01-580 4000
52 Tottenham Court Road, London, W1P 0BA
OPEN: MON-SAT 9.30am - 6.00pm LATE NIGHT: NONE

LONDON 01-629 1234 ext 3914
Selfridges (1st floor), Oxford Street, London, W1A 1AB
OPEN: MON-SAT 9am - 6.00pm LATE NIGHT: THURSDAY 9am - 8pm

To: Silica Shop Ltd, Dept PCW/28.09.89, 1-4 The Mews, Hatherley Road, Sidcup, Kent DA14 4DX.

PLEASE SEND ME FREE LITERATURE ON THE AMIGA

Mr/Mrs/Ms: Initials: Surname:

Address:

Postcode:

Do you already own a computer
If so, which one do you own?

HOTLINES

I walked into a bar and ordered a pint of whisky, and the barman said: "You must be joking."

"If you don't serve me there's going to be trouble," I threatened, and he said: "Who do you think you are matey, Rommel?"

I laughed and pointed to my sand-swept hat, my dirt-

tering up the TV at the moment, thank goodness America's finest export is back on our screens again. Yes, the American Football season has started and the Raiders have made their usual inconsistent start. Will anything ever dislodge *TV Sports Football* from the top of the Evans shelf? It could be *John Maddens Foot-*

grand strategic level and covers every area of the conflict from Gibraltar to the Urals, with each game in turn representing three months. Armies can contain tanks, paratroops, infantry, air support and mechanised forces. You can order armies around, mount amphibious landings, launch U-Boat fleets, mount bombing raids and tons of other stuff.

On top of the war-making, there's the production side which must balance vital war goods against developing war winning secret weapons. There are multiple scenarios and different starting levels for each country. Considering that *Colonial Conquest* was an excellent game, this is one to get seriously excited about. According to Danielle at US Gold it's now in the shops, so check it out.

The Austins, the core of Level 9 Computing, are abandoning the adventure field in which they rose to fame, before being outclassed by *Magnetic Scrolls* and *Infocom*. *Scapeghost* is the name of their swansong, in which you play a ghostly ex-cop. Your task is to clear your name in three days. The game will be available at the PC Show, and then by mail order. Ring 0934 814450 if you're interested. The company, is concentrating on developing games and converting them with its H.U.G.E system for the Amiga, ST, Mac and PC. According to Johnny Cook, who knows about these things, if little else, it's the best thing since sliced bread, because an arcade game written on one format can be re-compiled to run on the other formats in a matter of minutes.

Anyway, as a final goodbye to Level 9, here's a picture of the boys for old times' sake.

Duncan Evans

ball, which will be on the streets at the beginning of October but then again it might not.

What with the 50th anniversary of World War II occupying prime-time TV, what we need is some enterprising company, or at least one with enough sense to grab a golden marketing opportunity, to produce some spiffy wargames. The American (again!) mob, SSI, is shortly to release *Storm Across Europe* on the C64. This is an epic one to three player simulation from the author of *Colonial Conquest* that allows for the recreation of the entire war. This is on a

■ Saying goodbye with a smile, the Austin boys.

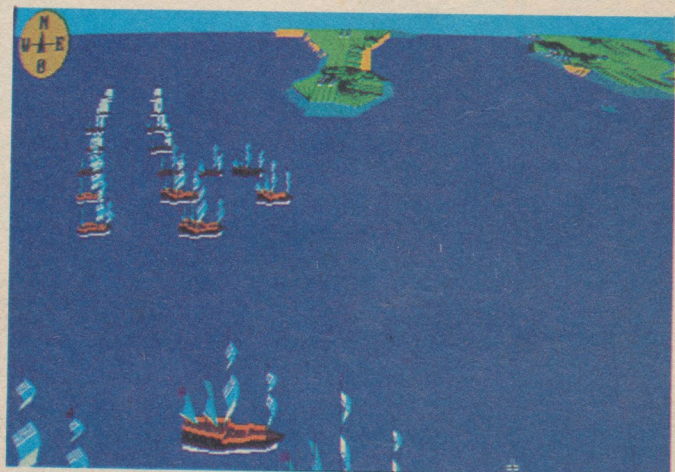

■ I may be a weak and feeble computer game... relive the Armada with the Battlescape series.

encrusted boots, the Africa Corps uniform, and said: "Got it in one. Now do I get my pint or do I invade North Africa?"

Now you might think that your favourite software scribe is one division short of a regiment, and you might be right, but I developed that great thirst during evenings I've spent playing Rommel on the PC from Electronic Arts. And you too can run rampant across North Africa in eight different scenarios.

Alternatively, you could give the Spaniards a good hiding in a recreation of the great Armada. Using a system games similar to that used in *Borodino* the Atari games product is being revealed at the PC Show. This is the second in the Battlescape Series and casts you as Lord Howard defending good old Blighty, or as a Spaniard, leading the Armada in complete ruin when you get trashed by the might of the glorious English empire.

With the crushing tedium of *War and Remembrance* clut-

GAMESCAN

TOP-TWENTY FULL PRICE CHARTS

No.	Title	Last Week
1	Robocop Ocean	2
2	Indiana Jones - Last Crusade US Gold	1
3	Xenon 2 Mirrorsoft	NE
4	Passing Shot Mirrorsoft	NE
5	New Zealand Story Ocean	4
6	Batman - '88 Ocean	3
7	Bloodwych Mirrorsoft	19
8	Rick Dangerous Rainbird	5
9	Forgotten Worlds US Gold	9
10	Dragon Ninja Ocean	7
11	Vigilante US Gold	13
12	Kenny Dalglish Soccer Manager Cognito	10
13	Licence To Kill Domark	6
14	Emlyn Hughes International Soccer Audiogenic	14
15	Populous - Promised Lands Electronic Arts	11
16	Silkworm Virgin	12
17	Operation Wolf Ocean	8
18	APB Tengen	17
19	Treble Champion Challenge Software	RE
20	Run The Gauntlet Ocean	16

COMPILED BY GALLUP

Amiga 500 Users

**NEW
FEATURE
NOW SHIPPING
With AUTOBOOT/
GAME
SWITCH**



RAM Expansion & Autobot Module
(Optional)

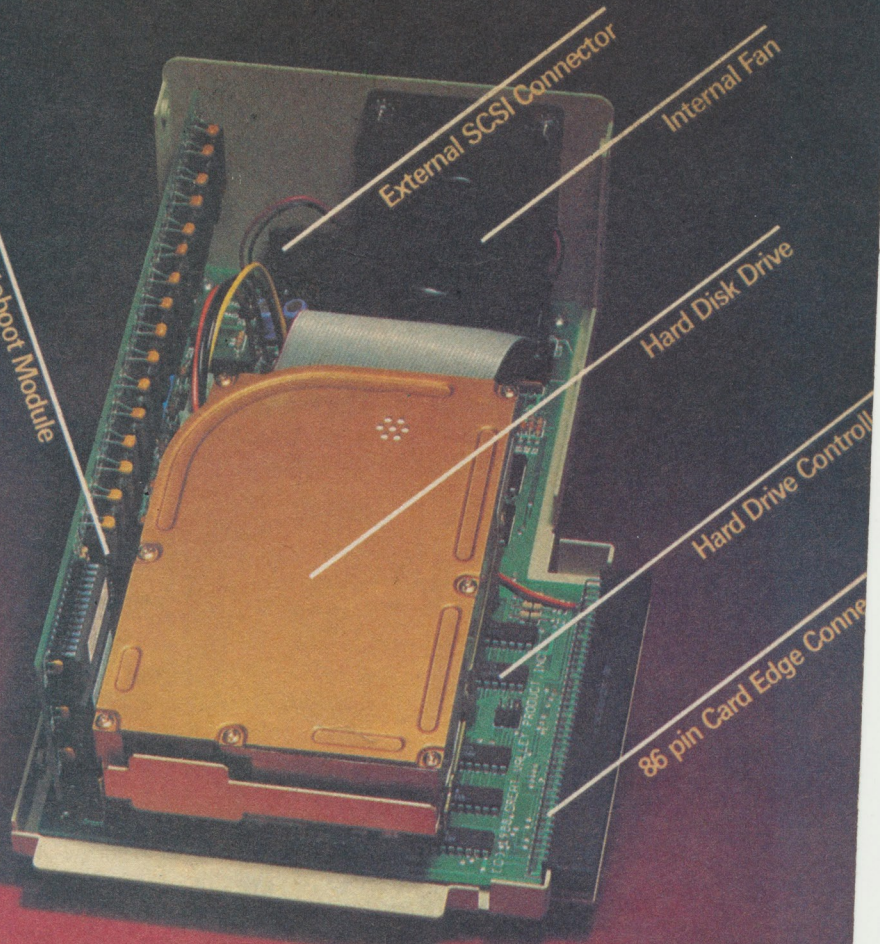

The Ultimate Expansion Tool!

**Incredible Value at Incredible Prices
Starting As Low As \$599.00
with Introductory Offer**

ACT NOW and get up to \$150.00 Factory
Discount with purchase of the Impact A500
(And coupon below)

Hard Disk Drive SCSI 3 1/2" Hard Disk Drive, available from 20 to 102MB, capable of storing up to 118 diskettes

Hard Drive Controller DMA, Direct to onboard 16kb Buffer, provides Amiga 2000 Performance.

86 pin Card Edge Connector This compact snap-on unit connects directly to Amiga bus ensuring the highest possible performance and reliability.

RAM Expansion & Autobot Module Internal Zero wait-state 2MB FAST RAM expansion plus boot directly from the Hard Drive. [Optional]

External SCSI Connector Connects up to 6 additional SCSI devices.

Internal Fan Keeps you cool.

As well as Amiga 500 and 2000 machines we can supply ART, GRAPHICS, ANIMATION, DESK TOP PUBLISHING, VIDEO TITLING, COMMUNICATIONS, MUSIC/MIDI SYSTEMS, COMMODORE and SAMSUNG PCs, technical support, system design and bespoke software.

★ **12-months warranty on all hardware, first-class service.** ★

★ The above machine is currently under special offer! ★

Final stock clearance – only £600 incl VAT
(please add £5 p&p)

**BRING THIS AD TO OUR NEW CENTRE, AND WE WILL
GIVE YOU A FURTHER £50 – YES £50 – DISCOUNT!**

"AN UNBEATABLE OFFER FROM AN
UNBEATABLE COMPANY!!"

**MICRON
COMPUTER
CENTRE**

TOTAL SYSTEMS SOLUTIONS
41 CROUCH STREET, COLCHESTER, ESSEX CO3 3EN.
Tel: (0206) 769398. FAX: (0206) 576904.

Please send my order of:

Name:

Address:

Credit Card No:

Telephone No:

ACCESS



Take Your Pick

POPULAR COMPUTING WEEKLY
INCORPORATING **GAMESWEEK**

C64 REDESIGNED
... AGAIN! BUT IS CBM FLOGGING A DEAD HORSE? See News, p.3

286 PC FOR PRICE OF AN XT! p.4

UPGRADE, BUT WHY NOT CUT AMIGA PRICES?

UPGRADE IN A LIPSHOT!

VIDEO MURDER'S START HERE!

ATARI ST New games like Legions, Death, and more!
p.12

COMMODORE 286 packages mentioned for both ST and Amiga.
See Amiga special section: from news developments, p.8
Amiga budget 286 packages reviewed on p.20

AMSTRAD The PC-XT/ST Spectrum look II gives the area over, p.14
286 for the Amstrad PCW read previous. Amiga and Amstrad see p.22

PC COMPATIBLES PC look itself: a special comparison for the reader, see p.10
286's old-on-the-line for the XT/ST, the new, p.2
286's PC emulators, p.4

CORRUPT COMPUTING BB: NAZI TERRORISTS? WE FIND OUT ON PAGE 12!

Popular Computing Weekly — the essential item on your shopping list. Up-to-the-minute news, views, advice, hardware and software reviews ... PLUS your FREE **Computer Gamesweek** supplement in every issue. Only 55p. On sale Thursday.

Which PC — the critical PC buyer and user guide. **Which PC** investigates the hardware/software market. Every issue our Buyers' Guides inform you of the options available ... makes buying easy. A large glossy magazine ... with bite! Only £1.45 Monthly.

£1.25
U.S. \$3.00
U.K. £1.75
Pp. 128
P. 18.00

WHICH PC
A Focus Magazine publication
March 1989

AT EXCLUSIVE
Three new contenders

WHAT'S ON THE MENU?
Buyers' guide to word processors

WHICH COMPUTER? SHOW PREVIEW
Twenty pages of what to see

June 1989 £1.25

AMSTRAD PC

Speak my language
First of a major new series

On the market
Stockbroking software reviewed!

Heart of the machine
Inside your Amstrad

Amstrad Professional Computing — the official title for the professional user of Amstrad machines. Seriously researched features looking at the applications of Amstrads in business. Only £1.50 Monthly.

Amstrad PCW — the official monthly magazine dedicated to the 8,000 and 9,000 series Amstrads. Programming in Mallard Basic, software and book reviews and clear guides to word processing packages ... make sure you get the most from your word processor. Only £1.45 Monthly.

U.K. £1.45
U.S. \$3.50
U.K. £1.85
Pp. 128

AMSTRAD PCW

Fishy tale
New game from Rainbird

THE OFFICIAL MAGAZINE FOR ALL USERS OF THE AMSTRAD PCW

Always greater

SINCLAIR Every month £1.75 May 1989

WHAT DOES THE FUTURE HOLD?
Whither the QL?
— a view

WORLD

THE QL IN DISGUISE
WE SEEK MS-DOS EVERYWHERE ...
MS-DOS emulators on the QL

ADVENTURE REVIEW
Tower of Valagon

UPDATE YOUR FILES:
QD by Jochen Merz
Master Spy by ARK Software

PSION SOLUTIONS
Into the Archives ...

Sinclair QL World — the only magazine supporting the ever-popular Sinclair QL computer. QL Scene for news, details of the latest programs and add-ons available ... and more! Only £1.75 Monthly.

Amstrad Computer User — the official magazine for Amstrad CPC users. Packed with games, news, tips and ideas to unlock full value from these popular machines. We advise on what's available and how good it is even before it hits the streets! Only £1.25 Monthly.

Computer User

Fast, furious, funny fun!

SKWEEK

WITH **CD-ROM**

Question of Sport Crazy Cars II RockStar Emlyn Hughes International Soccer

Plus... DOS Comparison Fun Street II review Neon Online Application Advice Holly Hacking 101ers

MEET EMLYN HUGHES!

Order your copy from your newsagent today. Subscriptions available.
Focus Magazines, Greencoat House, Francis Street, London SW1P 1DG. Tel: 01-834 1717.

PASSING SHOT

"Anyone for tennis?" he said, starting his review in the most clichéd way possible, but then salvaging his street cred by adding: "Probably not, as it's September and Wimbledon was three months ago." The timing is completely off, but then as the licence to the coin-op *Passing Shot* was grabbed just as the tennis season was drawing to a close, it is to be expected. Programmers cannot write good software in a day you know (half of them could not write a good game if they had the rest of their lives to do it, but enough of that).

Passing Shot is the latest addition to the world of strawberries and cream, of which I am very fond; it as my portly stature reveals gives you the chance to be Bonking Boris, or Steffi the Stunna, as *the Sun* would have it. You can actually play a

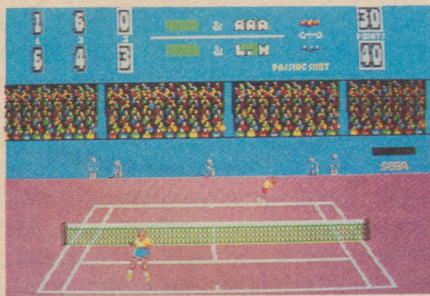

◆ Serving out of season.

male or female, through the singles or doubles Grand Slam season.

If two people are playing, then strangely enough they play on the same side in the doubles game rather than against each other.

You play in the finals of all the tournaments except Wimbledon, which needs to be slogged through from the earlier rounds.

The graphics are presented from two viewpoints. Firstly from behind the server, as they whack the ball over the net, then switching to the action perspective, from above. It has the look of a tennis version of *Kick Off* with smallish player graphics, and a scrolling court. Strange colours on the ST version, changing with the surface, and due colours on the quite slow Amstrad CPC version. The gameplay is essentially the same, it still being necessary simply to get your player in position and then select your shot. The computer decides roughly where the ball is going to go. You can hit the ball flat, lob it, slice and topspin it in your efforts to get the ball past the opposition. The trouble is that the opposition likes to smash the ball, while you have no obvious counterpart.

The scrolling is reasonably good on the ST, a little jerky on the CPC, but the graphics are a little unimpressive.

The Popular camp reached a split decision on *Passing Shot*, some thinking

it was dire, while others spent the afternoon shouting "smash it", "lob", and especially, "You aren't very good at this game, are you Duncan?" Me, I quite liked it, but there is a lot of difference in the

F A X

Version: ST/CPC
 Price: £8.99-£19.99
 Supplier: Mirrorsoft
 Reviewer: Duncan Evans
 ST, CPC, Spectrum: Out now
 Amiga: Out shortly

R A T I N G

Graphics: 70%

Sonix: 67%

Gameplay: 78%

Overall: 75%

versions for each machine.

Passing Shot is not great by any stretch of the imagination, but it does have skill levels, tournaments to keep you playing, and an engaging two player option where you and a friend can take on Martina and Boris in a mixed doubles final at Wimbledon. □

SHUFFLEPUCK CAFÉ

I have read contrived plots before, but the one accompanying *Shufflepuck Café* takes the biscuit. Late one night in the 25th century, on returning home from a night out with the boys/girls/aliens/droids (delete as applicable), you decide to 'phone home. Stopping by the *Shufflepuck Cafe*, you are about to make the biggest mistake of the night; going in. Before they let you use the phone, the regulars, a collection of real sleazeballs, insist that you join them for a game of air hockey, or "shufflepuck" as it's known



● "I only came in for a cappuccino."

hereabouts. And they will not let you out of the door unless you do.

Well, a fairly thin coating of gloss on what is a pretty simple game format, but it all serves to make the game a little more interesting.

On top of the great box, there's some seriously groovy music on the Amiga (hard luck ST owners, this is what you get for paying £100 less). Then you are into

the café itself. You can either play a one off against one of the gang, or try the championship trail whereby each and every one of them has to be defeated in turn. Each of your opponents plays differently, and all are graded in difficulty, the first three being easy for novice players, while the last two are a very stiff challenge. Biff Raunch is the ultimate opponent in terms of sheer skill, but Princess Bejin is the one who caused me most trouble.

She uses her mental powers on her serve to manoeuvre the puck halfway up the table, before slamming it into your midriff. Each time the puck beats a player, the glass covering the table-ends shatters horribly convincingly. Obviously, the local DIY merchant makes a fortune out of this lot because the glass is replaced after every point.

You can alter your bat capabilities just to keep it interesting, with size, bounce and power. Having a bat half the size of the table is fine for spineless wimps, but it's cumbersome to move and you don't get any spin off it. Bounce is how fast the puck leaves your bat on contact, while power is simply how fast you can whack it. Set a very low bounce factor and you can block shots then belt them.

The graphics are nicely done in 3-D, with the puck changing in size, but it is the characters themselves that really shine in

F A X

Version: ST/Amiga
 Price: £19.95
 Supplier: Domark
 Reviewer: Duncan Evans
 ST: Out now
 Amiga: Out now

R A T I N G

Graphics: 75%

Sonix: 90%

Gameplay: 80%

Overall: 82%

this department, all with their own quirks and sound effects.

Bat handling is difficult, so you cannot complete the game in half an hour, but it is responsive enough for the beginner to trounce the slower players. It's the sonics and gameplay which really make *Shufflepuck Cafe*, the former being crisp and the latter being addictive. Air hockey is a very simple game, which is why some companies have bundled it with collections of games, so Domark has got to be pretty confident in this Broderbund sourced product to sell it on its own. Having spent half the afternoon playing the damn game, myself, I think their marketing people just might be right. □

COMPUTERS IN THE MOVIES

Pop corn, Kia-ora, Cornettos and . . . micros? The computer is now part and parcel of the celluloid experience. Leslie Bunder sifts through the archives to discover how the machines have been treated by Hollywood.

FILM MAKERS have rarely got to grips with what computers are all about and consequently the role of computers in movies has often been a complicated issue.

On the one hand, computers are shown as being of great benefit to society while on the other hand they are written off as an evil menace. The micro in the movie has been without doubt subjected to some of the worst forms of stereotyping and characterisation.

Often, the role of the computer is still largely influenced by sci-fi writers. They are seen as controlling and influencing societies and being able to make humans control them. From evil machines which have the power to rape women, in *Demonseed* (1976), through to the all-action

- ◆ Right: Robocop gets his computer fix.
- Below: Working girls get more than job satisfaction from their VDUs.



video game spectacular of Walt Disney's *Tron* (1982), computers have been featured at all levels to cater for different tastes, from the comic to the erotic and from the surreal to the avant garde.

Just how far events in real life are influenced by film makers is a question worth exploring in relation to the impact computers make on the big screen. Sure, computers which have the power to rape women are pure sci-fi, but can hacking lead to the events as shown in *Wargames* (1983)? Here, teen heart throb Matthew Broderick plays an adolescent who is rather keen on computers and accidentally manages to log on into the computer controlling America's nuclear defence.

Broderick thinks he has found himself a new game and so starts the countdown to a possible World War III. With much powerful comms software available these days, and many people trying to get on-line, could such an event occur? Well, anything is possible and with hackers these days getting more and more sophisticated, getting into such a system that Broderick gets onto, is quite feasible.

When boy wanted to meet girl in *Electric Dreams* (1984), boy enlisted the help of his handy computer. To woo her love, he got his micro to compose little musical melodies but eventually the computer gets jealous of the love affair. But, like all celluloid romances, it all works out in the end and everyone lives happily ever after.

Again, computers figured quite highly when it came to love in *Pretty In Pink* (1985). This time the plot centred on highschool computer terminals. Here, boy doesn't know how to ask girl, so he uses the school network to transmit his somewhat impersonal "I love you" message to her terminal. Naturally, the female lead falls for this ploy and is forever smitten with the rich whizz. Well you would, wouldn't you? (And why not - Ed?).

● Humorous or what?

Can computers be funny? In a few instances there have been films which involve computers in comic roles. Walt Disney's production *The Computer Wore Tennis Shoes* (1969) involves a boy who has all the knowledge contained within a computer database injected into his unsuspecting brain with comic results. Sensing they were onto a winner with this format, Walt Disney came out with *Now You See Him, Now You Don't* (1971) in

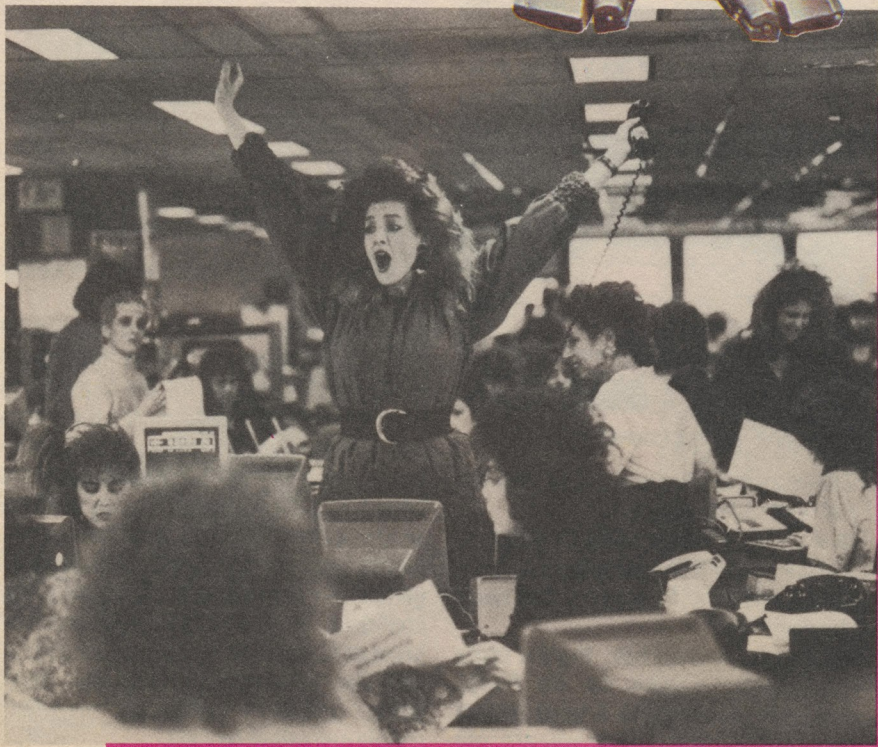



● Above: In *Running Man* convicts are shackled not by a cumbersome anklet but by computers. Below: *Short Circuit* blowing a celluloid fuse.

which our super-charged computer-whizz designs/invents an invisibility spray, presumably with some off-screen chemical CAD system.

Love, romance and comedy are largely the exceptions in computer movie-making. They star (or just crop up) far more in "real life" situations and sci-fi. Recent real life situations, where computers are accurately represented include *Working Girl* where all office scenes featured the ubiquitous PC's doing their groovy WP (etc) stuff. In the highlife/lowlife of *Wall Street* (1988), the capitalistic computing of share dealing was well portrayed (possibly due to the fact that a well known computer company paid for their computers to be shown).

In the current James Bond film *Licensed To Kill*, CD-ROM technology is demonstrated when a buddy of big Jim Bond uses a micro to save and retrieve data on a CD disc.

A touch of neurons

But of course, it is the sci-fi films where computers really come into their own, often with hilarious results.

In *Battle of The Stars* (1979), aliens from the planet Gona have deposited their supreme being on Earth and plan to take us over in 300 years. Surprise, surprise, the supreme being turns out to be a computer.

In *Billion Dollar Brain* (1967), an agent uncovers a plot by a mad American millionaire to take over the world – and helping said Yank is a very talkative computer.

Many movie makers believe in the analogies between human brains and computers. The simplistic likening of multi-input and multi-output neurons to transistors doesn't seem to stop the plain daft films: in *Brainwaves* (1982), a road accident victim is revived by squirting the stored "brain data" from a corpse into her



concussed bonce. As shock-horror luck would have it, the data being transmitted is that of a murdered woman . . . so our hero wakes up to recall the terror stricken last moments of the murdered woman . . .

In Arnold Schwarzenegger's *Running Man* (1987), our man Arnie lives in a prison camp of the future – a computer controlled Wogan show where the guests don't live long enough to see *Brookside*.

Also looking into the future were the producers of *The Curious Female* (1969), with its computer controlled society where sexual permissiveness is the norm and romance is banned – virtually making romance the pornography of the time with the Mills and Boon up on the top shelf in WH Smith!

In *Robocop* (1987) conventional computers are not seen very often, for it is the Robocop who, like Schwarzenegger's *Terminator*, boots up like a computer himself. His retina is a VDU with on-screen prompts, while Arnie's character has Mac-like menus in his head, from which he selects user-friendly appropriate actions (like KILL, MUTILATE, WASTE or DESTROY).

Artificial intelligence is another area which has been explored by dynamic directors. *Crosstalk* (1982) has an "intelligent" home looking after its old inventor. The computer starts worrying about

the future as a result of its cleverness: "What will happen to me when the old man dies?" it wonders. Interesting, but daft.

Also concerned with the future, is a golden oldie film: *The World Will Shake* (1939). Here, a computer can predict anybody's moment of death, resulting in a series of civil disobedience, social disorder and a spattering of killings and suicides. Given a system into which we can feed in all our medical details, a day may dawn when instead of just getting an idea of the drugs we need, we could also predict a date for our own death. But who

would want to know?

But it is *Tron* (1982) which is a must for anyone into computers. Here, a computer fanatic is taken out of the User world (our real life) and into the world of the Programs (inside the microprocessor system). Here, he meets Tron who is struggling to communicate with the Users world to get his program into the system. Then it becomes a classic case of good against bad as our whizz kid and Tron fight it out against the baddies in a series of video games. Great stuff.

Well, of course micros have been featured in literally hundreds of movies, both on celluloid and videotape. *Star Trek*, *Star Wars*, *Things To Come*, *Blade Runner*, *Alien*, *Superman*, *The Terminator*, *Metropolis*, *Top Gun*, *Batman*, *Short Circuit*, *ET*, the list just goes on and on.

With a new decade around the corner, it will be interesting to see how the movie industry treats micros. Will they carry on stereotyping them, or will they try to understand what the computer actually does, instead of fabricating beyond all belief. With the up and coming rise of biotechnology and genetic engineering, it could be that computers as a fantasy medium will be forgotten about as the movie business jumps on a new hobby horse. But then again it could just get worse . . . □

PUZZLE

Last week I treated myself to one of those combined watch/calculators to save me having to carry a separate calculator around with me. The time display showed the hours and the minutes and worked on a 24 hour clock. As it was midnight when I first unpacked it I set the time to 00:00 and went to bed.

Next morning I was awoken at 7:30 by my radio alarm and was rather astonished to note that my new watch was displaying a time of 12:18. As each minute passed the displayed time changed quite erratically. At eight o'clock it showed 04:24 while at twenty past the display registered 10:95. "Ten ninety-five," I muttered to myself. "This has got to go back!"

Later that day I returned to the shop from where it was purchased and explained the nature of the problem. "See!" I announced dramatically, placing the watch on the counter.

"Well, Sir," replied the salesman. "It looks alright to me. In fact it is exactly correct."

Sure enough, the time displayed was precisely the same as that shown on the other clocks in the shop. Somewhat puzzled I picked up the watch and left the shop. However, I had not walked far up the High Street before I noticed that the display was again doing peculiar things, so I scuttled back to the shop as quickly as I could for a replacement.

CALCULATED WRIST

Gordon Lee buys a watch and cannot believe his eyes.



Some weeks later when I called again at the shop the salesman informed me that investigations by the manufacturers revealed that the timekeeper and calculator functions of the watch had become confused. The watch had been taking the square root of the number of hours, adding this to the square root of the number of minutes, multiplying the result by 1.5 and then displaying this answer to two decimal places. In this way it appeared as though a time was being displayed with the decimal places taking the place of the minutes.

Now that you know this, you should have no difficulty finding out at what time of day I first returned to the shop with the faulty watch. □

Solution to last week's puzzle . . .

The next three boards are those of orders 25, 169 and 1,156 which have 3,025, 142,129 and 6,677,056 holes respectively. These numbers are all perfect squares.

From last week's diagram it is easy to devise a formula to give the number of holes in each order of board. This is $5n^2 - 4n$ where n is the order number of the board. This can be seen to be the case as each board comprises of almost five square groups of holes except for the overlap where the four arms of the board are arranged around the central square. The number of holes which overlap is equal to $4n$.

The simple listing shown here should produce the solution. It calculates the number of holes (DOTS) present in all boards from order 1 upwards. The square root of this number is calculated (line 120) and this is tested in line 130 to see if it is

```
100 N=1
110 DOTS=(5*N*N)-(4*N)
120 S=SQR(DOTS)
130 IF S=INT(S) THEN PRINT N;" ";DOTS
140 N=N+1:GOTO 110
```

integral – that is, the number of dots could be arranged in the form of a perfect square.

Unfortunately, this listing might not work on all computers. The reason is that some micros can be slightly inaccurate when working out square roots and the computed value can be a minute bit greater or smaller than the true amount. This difference is usually so small that it is not displayed on the screen when a square root is printed out but it is retained in the computer's internal register and will therefore influence any decisions made upon it – for example, in an IF/THEN statement. As a test for your micro try this short routine:

```
10 N=1
20 S=N*N : R=SQR(S)
30 IF R<>N THEN PRINT N
40 N=N+1:GOTO20
```

The program simply finds the square of each integer in turn and then computes the square root of this value. This should be equal to the original number but if it differs then the current value is printed out. If your micro prints any numbers then these are the ones that it is getting wrong.

To get around this problem substitute the following for line 130 in the solution listing:

```
130 S=INT(S+0.5):IF S*S=DOTS THEN PRINT N;" ";DOTS
```

Here, the computer square root is rounded to the nearest whole number and this is then tested by direct multiplication with the original number. □

520ST-FM SUPER PACK



The Atari Super Pack is ideal for you if you want to get off to a flying start with the best in entertainment software. The Pack includes a 520ST-FM with 1Mb RAM, a built-in 1Mb disk drive, over £450 of top games and a joystick. If you buy the Super Pack at Silica Shop, we will add our own ST Starter Kit (worth over £200), Free Of Charge. Return the coupon for details.

£399

INCLUDING VAT

With SM124 mono monitor: £498 INC VAT

With SC1224 colour monitor: £698 INC VAT

1Mb DISK DRIVE £450 OF SOFTWARE

ARCADE GAMES

Arkanoid II	Imagine	£19.95
Beyond The Ice Palace	Elite	£19.95
Black Lamp	Firebird	£19.95
Buggy Boy	Elite	£19.95
Chopper X	Mastertronic	£9.99
Ikari Warriors	Elite	£14.95
Marble Madness	Electronic Arts	£24.95
Quadrailen	Logotron	£19.95
Ranarama	Hewson Consultants	£19.95
Return To Genesis	Firebird	£19.95
Roadwars	Melbourne House	£19.95
Starquake	Mandarin	£19.95
Test Drive	Electronic Arts	£24.95
Thrust	Firebird	£9.95
Thundercats	Elite	£19.95
Wizball	Ocean	£19.95
Xenon	Melbourne House	£19.95
Zynaps	Hewson Consultants	£19.99

SPORTS SIMULATIONS

Eddie Edwards Super Ski	Elite	£19.95
Seconds Out	Tynesoft	£19.95
Summer Olympiad '88	Tynesoft	£19.95

PRODUCTIVITY SOFTWARE

Organiser	Triangle Publishing	£49.95
-----------	---------------------	--------

JOYSTICK

Atari CX40 Joystick	Atari Corp	£4.99
---------------------	------------	-------

FREE ATARI BUNDLE VALUE: £458.97



ST COMPUTERS

The range of Atari ST computers offers something for everyone. From the games enthusiast who wants the challenge of the very best in arcade action, to the businessman who wants to make financial forecasts or faultless presentations. The ST offers high quality graphics, sound and speed for the gamer, whilst providing a fast, user friendly and affordable solution to business. The ST is now firmly established in the home environment and boasts a wealth of users in education, local government, television, and a variety of different businesses. Software for the range stretches to cover applications as diverse as ENTERTAINMENT, ACCOUNTS, ART, COMMUNICATIONS, COMPUTER AIDED DESIGN, DATABASES, DESKTOP PUBLISHING, EDUCATION, MUSIC, PROGRAMMING, SPREADSHEETS, WORD PROCESSING and more. For a full list of the software available, as well as details of the ST range, complete and return the coupon below.

All prices correct at the time of going to press. £8.00

520ST-FM EXPLORER PACK WITH BUILT-IN 1Mb DISK DRIVE



The value for money offered by the Atari ST range is reflected in the Explorer Pack featuring the 520ST-FM computer with 512K RAM. The 520ST-FM computer now comes with a built-in 1 Mb double sided disk drive as well as a free mouse controller and a built-in TV modulator. The new 520ST-FM Explorer Pack includes the 520ST-FM computer, the arcade game Ranarama, a tutorial program and some useful desktop accessories. In addition, if you buy the Explorer Pack from Silica, we will give you the Silica ST Starter Kit worth over £200, FREE OF CHARGE. Return the coupon for details of our Starter Kit and of the full ST range.

£260

ONLY £2.51 PER WEEK RETURN COUPON FOR DETAILS

+ VAT = £299

+ SM124 mono monitor: £398 INC VAT + SC1224 colour monitor: £598 INC VAT

1040ST-FM PROFESSIONAL PACK

NOW WITH TV MODULATOR

For the serious home user and the small business, we are pleased to announce a new package based around the 1040ST-FM. The 1040ST-FM has 1Mbyte RAM and a 1Mbyte built-in disk drive. In addition, the 1040ST-FM now comes with a TV modulator built-in. (The previously available 1040ST-F was designed for use with a monitor only and did not come with a modulator.) This modulator allows the 1040ST-F to be plugged directly into any domestic TV set, and comes complete with a lead to allow you to do so. The new 'Professional Pack' from Silica includes the new 1040ST-FM with modulator plus four high quality software packages including a spreadsheet, database, word processor and programming language. This 'Professional Pack' software will enable you to get straight down to business with your new computer. In addition to this software (worth £384.84), if you buy the Professional Pack from Silica Shop, you will also receive the Silica ST Starter Kit (worth over £200), Free Of Charge. Return the coupon for further information.



£499

INCLUDING VAT

With SM124 mono monitor: £598 INC VAT

With SC1224 colour monitor: £798 INC VAT

ATARI 1040ST-FM	(Computer)	£499.99
VIP PROFESSIONAL	(Spreadsheet)	£149.95
MICROSOFT WRITE	(Word Processor)	£149.95
SUPERBASE PERSONAL	(Database)	£59.95
BASIC DISK & MANUAL	(Language)	£24.98

NORMAL RRP: £884.82

LESS DISCOUNT: -£385.82

PROFESSIONAL PACK PRICE: £499.00

2Mb & 4Mb MEGA ST

The MEGA ST computers are styled as a lightweight keyboard with a separate CPU, connected by a coiled telephone style cable. There are two versions of the MEGA ST, one with 2Mbytes of RAM and the other with 4Mbytes. Each version has a 1Mbyte double sided disk drive built-in to the CPU unit. The MEGA ST's do not come with modulator built-in and must therefore be used with a monitor. With every MEGA ST purchased, we will add the 'Professional Pack' software (worth £384.83) detailed above, plus the Silica ST Starter Kit (worth over £200) both Free Of Charge. Return the coupon for further details.



2Mb MEGA ST

£899 INC VAT

+ mono monitor = £998
+ colour monitor = £1198

4Mb MEGA ST

£1199 INC VAT

+ mono monitor = £1298
+ colour monitor = £1498

DTP PageStream £149 +VAT = £171.35

Desktop Publishing (DTP) is one of the fastest growing applications for personal computers. We are pleased to announce a powerful low cost package for the Atari ST called PageStream. PageStream costs only £149 (+VAT=£171.35) and, because it works with an Atari 1040ST and a Sekoishi SP-180AI printer, you can be up and running with a complete system for less than £1000. Some of the features of PageStream are listed to the right. If you would like further information on this program, complete and return the coupon below, ticking the 'DTP' box in the corner.

- * TEXT-FLOW AROUND GRAPHICS
- * ROTATION OF TEXT & GRAPHICS
- * SLANT OR TWIST ANY OBJECT
- * POSTSCRIPT COMPATIBLE
- * TAG FUNCTION
- * AUTO/MANUAL KERNING & HYPHENATION
- * GROUPING OF OBJECTS

DO YOU OWN AN ATARI ST?

If you already own an Atari ST computer and would like to be registered on our mailing list as an ST user, let us know. We will be pleased to send you copies of our price lists and newsletters FREE OF CHARGE as they become available. Complete the coupon and return it to our Sidcup branch and begin experiencing a specialist ST service that is second to none.

SILICA SHOP:

SIDCUP (& Mail Order) 01-309 1111
1-4 The Mews, Hatherley Road, Sidcup, Kent, DA14 4DX
OPEN: MON-SAT 9am - 5.30pm LATE NIGHT: FRIDAY 9am - 7pm

LONDON 01-580 4000
52 Tottenham Court Road, London, W1P 0BA
OPEN: MON-SAT 9.30am - 6.00pm LATE NIGHT: NONE

LONDON 01-629 1234 ext 3914
Selfridges (1st floor), Oxford Street, London, W1A 1AB
OPEN: MON-SAT 9am - 6.00pm LATE NIGHT: THURSDAY 9am - 8pm

To: Silica Shop Ltd, Dept PCW/28.09.89, 1-4 The Mews, Hatherley Road, Sidcup, Kent DA14 4DX.
PLEASE SEND FREE LITERATURE ON THE ATARI ST

Mr/Mrs/Ms: Initials: Surname:

Address:

Postcode:

Do you already own a computer
if so, which one do you own?

DTP

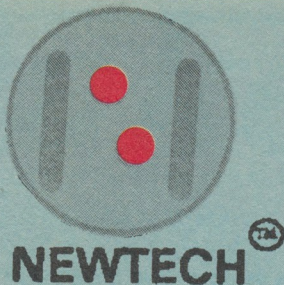

NEW TECHNOLOGY LIMITED
64 CRICKLEWOOD BROADWAY
LONDON. NW2 3DL
TEL: 01 450 1128
FAX: 01 452 8202

DRAGON™ DISK-TO-VCR TAPE BACKUP SYSTEM
UP TO 420 MEGABYTES BACKUP SYSTEM

DRAGON™ BACKUP SYSTEM + TOP SPEC BRANDED VHS VCR AT ONLY

£299.95



DRAGON™ BACKUP

£159.99

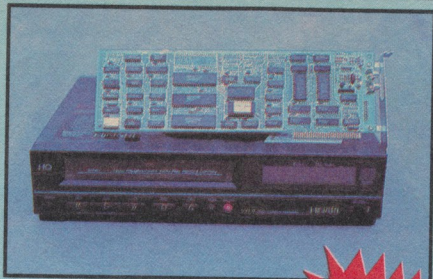

DRAGON™ + VHS VCR

£299.95

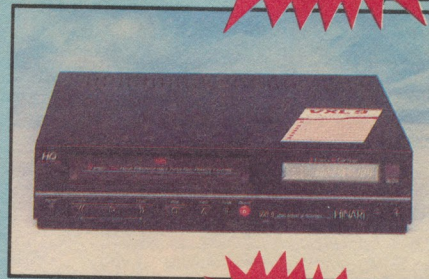

VHS VCR

£189.85

THE DRAGON
420MB TAPE BACKUP
SYSTEM

- ★ Plugs into any standard PC/XT/AT expansion slot.
- ★ Compatible with most standard VCRs. Both Betamax and VHS formats supported.
- ★ Up to 420 megabytes of data may be backed up on a single VCR tape.
- ★ Provides safety from hours of reinput of data or irrecoverable data loss through keystroke error, disk crash, power surges etc.
- ★ Transfers data at the rate of 12,000 bytes per second, or 1 megabyte per minute.
- ★ Quad redundant recording of data ensures data security.
- ★ More convenient than floppy disk backup.
- ★ Any disk device supported – hard disk, floppy disk, hard card, network disk, systems or other.

DRAGON SOFTWARE
FEATURES

- ★ **BACKUP** features allows you to back-up an entire disk as well as specified files and directories or designated types of files and directories such as only those created or changed since the last back-up or after a certain date.
- ★ **VERIFY** feature confirms that the VCR contains data that can be recovered or that the data tape is the same as on the disk.
- ★ **LIST FILES** feature makes a directory of files on the VCR tape.
- ★ **RESTORE** feature copies the data on the VCR tape to the disk.

VHS VIDEO
CASSETTE
RECORDER

- ★ **TWIN SPEED SYSTEM**
- ★ **PROGRAMMABLE FROM LCD INFRA-RED REMOTE CONTROL**
- ★ **6 PROGRAMME x 14 DAY TIMER**
- ★ **ADVANCED "HQ" FORMAT**
- ★ **ONE-TOUCH RECORDING**
- ★ **MADE IN JAPAN**

For further details please call us now on 01 450 1128 or return the coupon below to:
Ms Tracey Perrin, New Technology Ltd, FREEPOST, 64 Cricklewood Broadway, London NW2 4YL.

NAME: _____
 COMPANY: _____
 ADDRESS: _____

 TOWN: _____
 COUNTY: _____
 POST CODE: _____
 TELEPHONE: _____

Please rush me Units of the Dragon + Top Spec Branded VCR at £299.95 each.
 Please rush me Units of the Dragon Back-up System at £159.99 each.
 Please rush me Units of the Top Spec Branded VHS VCR at £189.85 each.
 Please send me further information on the Dragon Back-up System and the VHS VCR.

METHOD OF PAYMENT
 VISA ACCESS MASTERCARD AMEX DINERS CHEQUE ENCLOSED

CARD NO: _____
 EXPIRY DATE: _____
 SIGNATURE: _____



*** Introductory Prices for limited period only. Prices exclude VAT and are subject to change without notice.**
Please allow 15 working days for delivery.

All Registered Trade Marks recognised

HT COMPUTERS

COMMODORE AMIGA

AMIGA 500	£345.00
AMIGA 500 + COLOUR MON	£499.00
AMIGA 2000	£665.00

ATARI

ATARI 520 ST	£235.00
ATARI 1040 ST	£387.80

MASTER SERIES

MASTER 128	£339.15
BBC A3000	£599.00
BBC A3000 COLOUR MONITOR	£189.00

ZENITH DATA SYSTEMS

EAZY PC	£447.00
EAZY PC 2 DRIVES	£536.40
Z-159 MONO	£617.15
Z-159 COLOUR	£852.40
Z-159 20MB HD COLOUR	£1,100.00
Z-386 120MB HD	£4,100.00

AMSTRAD

PCW 8256	£327.70
PCW 8512	£416.00
PCW 9512	£499.00
1512SDcol £479.60 mono £400.40 EGA	
1512DDcol £563.88 mono £483.96 EGA	
1640SDcol £592.48 mono £498.39 EGA £688.17	
1640DDcol £657.44 mono £562.00 EGA £753.71	
1640HDcol £798.00 mono £698.00 EGA £898.00	
2086SDcol £715.00 mono £581.00 Hi Res £890.00	
2086HDcol £1067.00 mono £910.00 Hi Res £1237.60	
2386HDcol £2536.80 mono £2423.00 Hi Res £2740.00	

PORTABLES

CAMBRIDGE Z88	£199.00
ZENITH Z-184	£949.00
ZENITH Z-184 with 20MB Hard Disk	£1998.00
ZENITH SUPERSOFT 286 20MB HD	£2416.00
ZENITH SUPERSOFT 286 40MB HD	£3021.70
ZENITH SUPERSOFT 386 40MB HD	£3777.40

ARCHIMEDES

ARC 305 BASE	£599.50
ARC 305 MONO	£85.14
ARC 305 COLOUR	£794.76
ARC 310 BASE	£722.61
ARC 310 MONO	£767.91
ARC 310 COLOUR	£910.00
ARC 310M BASE	£767.80
ARC 310M MONO	£826.80
ARC 310M COLOUR	£965.36
ARC 440 BASE	£2188.92
ARC 440 MONO	£2221.37
ARC 440 COLOUR	£2356.42

COMMODORE PC1

PC1 MONO	£299.00
PC1 COLOUR	£399.00

PRINTERS

STAR LC-10	£145.00
STAR LC24-10	£229.00
STAR LASERPRINTER 6	£1040.00
EPSON LX800	£155.00
EPSON LQ500	£279.00
EPSON INK JET SQ2500	£999.95

H.T. COMPUTERS LTD

1 ARLINGTON ROAD, PETERSHAM, RICHMOND, SURREY TW10 7BZ. Tel: (01) 948 1681

NB Please telephone before calling – please add VAT at 15% and £10 courier delivery



**PHONE FOR MANY MORE GREAT DEALS
ONLY FROM HT COMPUTERS**



GET IT... BEFORE IT GETS YOU



For the AMIGA, ATARI ST (Col/Mono)
PC and Compatibles, and Archimedes

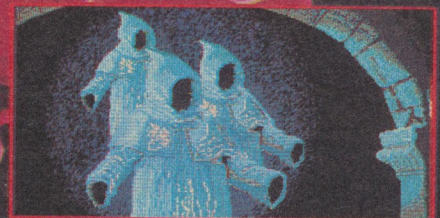

SOFTWARE SUCCESS MARKETING
Alban House, 24A White Pit Lane, Flackwell Heath,
Nr High Wycombe, Bucks HP10 9HR.

MEMORY UPGRADES

From Europe's only dedicated manufacturer and distributor for value added memory products.
ALL EX-STOCK FULL WARRANTY.

MEMORY MODULES

Plug in (SIMMS) DRAM Modules to expand your PC Memory.

OEM PRICING

SIMM PRICING (Qty 1.49)	£
256K x 8 - 120	26
256K x 8 - 100	29
256K x 8 - 80	33
256K x 9 - 120	29
256K x 9 - 100	35
256K x 9 - 80	40
256K x 9 - 60	49
1M x 9 - 100	112
1M x 8 - 80	118
1M x 9 - 100	118
1M x 9 - 80	124
1M x 9 - 70	129
4M x 9 - 80	CALL

Call for SIP pricing, £200,000 of module stock at all times.
Upgrade your MAC, SUN, BELL, IBM, NOVELL, AST, AMSTRAD etc.

LASER PRINTER UPGRADES

For HP Laser Jet II, IID and compatibles
1MB £190 2MN £290
4MB £465 (User expandable)

CHIP SUPPORT PRODUCTS

Memory and Co-Processor EX.STOCK, Examples:
256K x 1 - 10 £3.50 1M x 1 - 10 £8.50
64K x 1 - 10 £3.50 256K x 4 - 10 £8.50

VGA BOARDS

Graphics cards for the IBM PC AT/XT and compatibles. Also PS/2 Models 25 and 30.

Typical Extended VGA Mode	Card Pricing (£)
800 x 600 18 colours	from 159
800 x 600 256 colours	from 199
1024 x 768 26 colours	from 299

100% register and BIOS compatible with EGA and all VGA nodes

COMPAQ UPGRADES

100% compatible in size, shape and performance

ADD ON CARDS AND EXPANSION BOARDS

1MB and 4MB for models
DESKPRO: 386/16, 386/20, 386/20e, 385/25
386/2, 286s. NEW 386/33
PORTABLE II, III, 386, SLT/285

CALL FOR PRICING

IBM XT/AT UPGRADES

Extended/Expanded memory for PC Bus

512K	£295	1MB	£725
2MB	£490	2MB	£1225

PS12 MOTHERBOARD UPGRADES

Model	Size	£	Model	Size	£
30	512KB	345	70.A.21	2MB	365
30	2MB	345	80	1MB	280
50.70	2MB	345	80	2MB	150

PS12 EMS UPGRADES

512KB	£315	4MB	£745
2MB	£520	8MB	£1270

COMMODORE/AMIGA 500

RAM 500 £85 (512KB only)

NEW MINIMAX: Expandable to 2MB
Call for Pricing

ACCELERATOR PRODUCTS

Speed up your PC XT-compatible, to run DTP Spreadsheet, Macros, etc.

Providing 80286 CPU power with co-processor socket.

Tiny Turbo 286	8MHZ	3.0 x speed of XT	£199
Tiny Turbo Extra	12MHZ	4.5 x speed of XT	£249



Volume & Dealer Discounts Available



CALL 0252 3131155

DATRONTECH LTD
DATONTECH HOUSE, 33 GROSVENOR ROAD
ALDERSHOT, HANTS, GU11 3DP

FAX 0252 341939.

We are looking for talented people to join
our successful team

A good knowledge of machine code in either
Z80, 6502, 8086 or 68000
is required

We are waiting for you!

If you think you've got what it takes then
contact Mark Grimmer or see us at the
PC-Show at stand 3512.

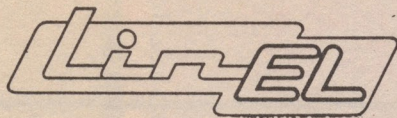

LINEL, Gütliststrasse, 9050 Appenzell, Switzerland.
Tel: 01041 71 87 49 19 · Fax: 01041 71 87 49 21

PROGRAMMERS

GRAPHIC ARTISTS

MUSICIANS

AT
VEKTOR GRAFIX
WE HAVE A RATHER
UNUSUAL ATTITUDE TO OUR
PROGRAMMERS

**We treat
them like people**

- Great Working Environment
- Nice Bosses
- Psion Organiser (possible)
- Personal Cell Phone (possible)
- Company Car (possible)
- Comfy Chair
- 286 or 386 Development Kit
- Parking Space (if you're early)
- Free Tea and Coffee
- Not Bad Salary

If you're interested in checking this opportunity
out then call Andy Craven or John Lewis
immediately.

We do not promise fast cars and
an exotic life style (though some of our
guys do enjoy that). What we offer, is a
relaxed, creative and friendly atmosphere.

■ WE NEED experienced 3D programmers to join
our existing development team to work on exciting
new projects for the 90's. We have immediate vacancies for
experienced 3D programmers on 68000
and MS-DOS.

■ For the right people the rewards are:-

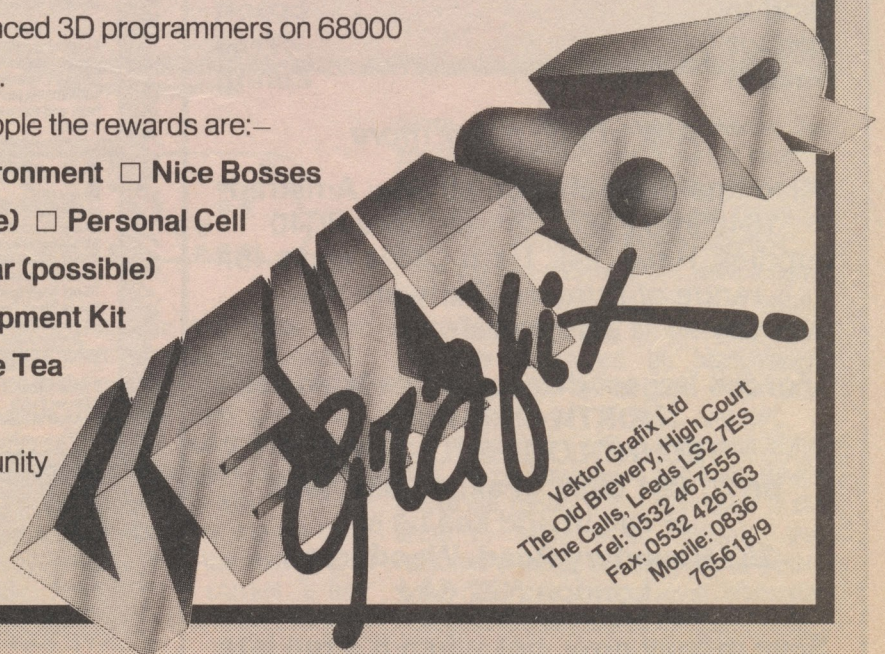

Vektor Grafix Ltd
The Old Brewery, High Court
The Calls, Leeds LS2 7ES
Tel: 0532 467555
Fax: 0532 426163
Mobile: 0836
765618/9

THE COMPUTER STORE

AMIGA HARD DRIVE AND CHIPS

COMMODORE A590 + 2 MEG (16 chips) FITTED	£629
COMMODORE A590 + 1 MEG (8 chips) FITTED	£519
COMMODORE A590 20 MEG HARD DRIVE	£399
256 × 4 CMOS D RAMS 120NS – 8 CHIPS £129.95 – 16 CHIPS £249.95	

COURIER DELIVERY £5 – C.O.D. BY COURIER £10

3 1/2" DSDD
75p
3 1/2" DSDD

**BEST QUALITY DISCS
WITH NO QUIBBLE
REPLACEMENT GUARANTEE
SINGLE DISC 75p
50 DISCS £37**

3 1/2" DSDD
75p
3 1/2" DSDD

**POST
FREE**

THE COMPUTER STORE 021-770 0468
UNIT 82 IN SHOPS 2-8 GREENWOOD WAY,
CHELMSLEY WOOD, BIRMINGHAM B37 5TL

**CALLERS
WELCOME**

POSSIBLY THE LARGEST AND CHEAPEST COMPUTER COMPANY IN LONDON?

From Amstrad to Zenith we stock the lot.

For example

Amstrad
Commodore
Samsung
Tandon
Apricot
Olivetti

Philips
Barbaton
Osicom
Epson
Wyse
Zenith

And many, many more

Also rate discounts on all new Amstrad
1640 and 2086, Commodore PC40
bundles, Hard Disk, Hard Cards and a full
range of Printers, Software and
Peripherals.

For the largest discounts available call
**NORTH CIRCULAR
TECHNOLOGIES (UK) LTD**
on 01-881 0685 Fax: 01-889 6002
or call in and see us at
268 Boundary Road, Woodgreen,
London N22 6AJ

Save money now, not when it's too late

WE SAVE'S SAVE'S SAVE'S SAVE'S SAVE'S
THE VERY BEST PRICES IN THIS MAGAZINE GUARANTEED!

Same Day Despatch

**TOP QUALITY PRODUCTS – LOW PRICES
NO GIMMICKS, JUST GOOD SERVICE!**

5 1/4" DISKS

When only THE BEST will do!
Price each disk inc VAT!
Double sided 48tpi 19p
Double sided 96tpi 22p
Double sided coloured 29p
Double sided reversable 32p
Double sided high density 1.6Mb
..... 59p

All disks are supplied with labels,
envelopes and w/p tags. We have very
carefully selected these disks for
outstanding performance (100% error
free) and extremely good value for
money!

ACCESSORIES

Mouse Mat £1.95
Mouse Mat (boxed) £2.25
Mouse Bracket £2.25
3 1/2" Head Cleaner (fluid) £1.95
Roll of 1000 3 1/2" labels £8.95
Ribbons – many types POA
Thingy Copy holder £1.95
Space Saver Printer Stand £19.95
Universal Printer Stand £4.95
Tractor Feed labels also available

CABLES

Printer Cable £3.25
4 Player Cable £3.49
Joystick/Mouse Extension £3.25
Scart £5.95

Our disk boxes are made by one of
the world's leading suppliers. We
have over 20,000 disk boxes in
stock! Buy with confidence.

CAPACITY	PRICE EACH	
	1+	5+
50	£3.49	£3.25
100	£3.95	£3.49
120	£4.95	£4.49

All are supplied with two keys, hinges
and ample dividers. NEW RANGE and
larger sizes! Made from antistatic
scratch proof plastic for reliable data
storage.

3 1/2" DISKS

**BEST VALUE – OUTSTANDING
PERFORMANCE
PRICE EACH DISK INC. VAT!**

Double sided double density 49p
Double sided coloured 59p
Double sided high density £1.29

All disks are supplied with labels.
Do not be put off by these low, low
prices, these are top quality disks and
have been very carefully selected: All
are 100% error free.

MELTON COMPUTER SUPPLIES

UNIT 20, DIGBY DRIVE
MELTON MOWBRAY LE13 0RQ

SHOP HOURS 9-5
MON-FRIDAY SAT 10-1
WHY NOT VISIT

Tel: 0664 410 666
Fax: 0664 410 221



All prices include VAT. Post add £3, Securicor Add £8.50
Bulk buyers please phone for 'SPOT' prices. E&OE. Export welcomed
All offers subject to availability. Please ask for full price list packed with money saving offers



SAVE'S SAVE'S SAVE'S SAVE'S SAVE'S

T.C. COMPUTERS

12a BARNARDS WAY, CHARLTON HEIGHTS,
WANTAGE, OXON OX12 7EB

* NEW AMIGA PACKS *

Amiga A500 Pack 1	£349
Amiga A500 Pack 2	£379
Amiga A500 Pack 3	£439
Amiga A500 Pack 4	£449
Amiga A500 Pack 5	£489
Amiga A500 Pack 6	£579
Amiga A500 Pack 7	£599
Amiga A500 Pack 8	£669
Amiga A500 Pack 9	£648
Amiga A500 Pack 10	£749
Commodore C64 Hollywood Pack	£140
Commodore C64 Entertainment Pack	£179

Atari 520 ST-FM New Power Pack	£349
Atari 1040 ST-FM Ultimate Pack	£469
Sinclair + 2 incl. Games & Joystick	£129
Sinclair + 3 incl. Games & Joystick	£179

Printers from £149, Disk Drives from £80

GO TO T.C. COMPUTERS



All prices include VAT

**OXFORDSHIRE'S PREMIER
COMMODORE DEALER**

WANTAGE 02357 60177 E.&OE

IT'S A PITY HE DIDN'T...



Commodore PC-10 III SD Mono	£570
Commodore PC-10 III SD CGA Colour	£710
Commodore PC-10 III SD EGA Colour	£890
Commodore PC-20 III SD 20Mb HC Mono	£825
Commodore PC-20 III SD 20Mb HD EGA Colour	£1199
Commodore PC-30 III SD 20Mb HD Mono	£1120
Commodore PC-30 III SD 20Mb HD EGA Colour	£1449

Atari PC-3 SD Mono	£610
Atari PC-3 DD Mono	£660
Atari PC-3 DD CGA Colour	£760
Atari PC-3 DD EGA Colour	£899
Packard Bell P8 500 SD Mono	£635
Packard Bell P8 500 SD CGA Colour	£740
Packard Bell P8 500 SD EGA Colour	£760
Packard Bell P8 500 DD CGA Colour	£820
Packard Bell P8 500 SD 20Mb HD EGA Colour	£1,079

Commodore PCs incl. FREE 12 month on-site warranty and 102 key keyboard
Packard Bell PC's incl. FREE software and 12 month on-site warranty.

ATARI PCs incl. FREE software and mouse.
Software at up to 30% OFF

AMIGA IMAGE

PO BOX 55
HASWELL
DURHAM DH6 2EU
Tel: (091) 526 2973 (24 hours)

AMIGA A500 AMAZING OFFER

£349.99

Title	RRP	AIP
APB	£19.99	£16.99
Archipelagos	£24.99	£19.99
Astaroth	£24.99	£19.99
Balance of Power 1990	£24.99	£19.99
Batman	£24.99	£19.99
Battlechess	£24.99	£19.99
Barbarian 2	£24.99	£18.99
Beach Volley	£24.99	£19.99
Big Top 0	£24.99	£18.99
Bio Challenge	£24.99	£19.99
Bloodwych	£24.99	£18.99
Blood Money	£24.95	£19.95
Datastorm	£24.99	£19.99
F-16 Combat Pilot	£24.95	£19.95
Federation of Free Traders	£29.99	£24.99
Forgotten Worlds	£19.99	£16.99
Grand Prix Circuit	£24.99	£19.99
Gunship	£24.95	£19.95
Indiana Jones	£24.99	£19.99
It Came From The Desert	£24.95	£19.95
Kick Off	£19.95	£14.95
Kingdom of England	£24.99	£18.99
Kristal	£29.95	£24.95
Licence to Kill	£24.99	£19.99
Lords of the Rising Sun	£24.99	£19.99
Microprose Soccer	£19.95	£16.95
Millenium 2.2	£24.99	£19.99
Passing Shot	£19.99	£15.99
Paperboy	£24.99	£18.99
Phobia	£24.99	£19.99
Police Quest II	£24.99	£19.99

Populous	£24.99	£19.99
Powerdrome	£24.99	£19.99
Quartz	£24.99	£19.99
Quest for the Time Bird	£24.99	£19.99
Rainbow Islands	£24.99	£19.99
Rick Danger	£24.99	£18.99
Robocop	£24.99	£19.99
Run the Gauntlet	£24.99	£19.99
RVF Honda	£24.99	£19.99
Silkworm	£24.99	£19.99
Skweek	£19.99	£16.99
Stunt Car Racer	£24.99	£19.99
The Duel-Test Drive II	£24.95	£19.99
The New Zealand Story	£24.99	£19.99
Thunderbirds	£19.99	£16.99
TV Sports Football	£29.99	£24.99
Vindicators	£19.99	£16.99
Voyagers	£19.99	£16.99
Weird Dreams	£24.99	£19.99
Xenon 2	£24.99	£18.99
Xybots	£24.99	£19.99

MEGADEAL

ARKANOID 2 (Ocean)
NOW ONLY £9.99
TETRAQUEST
NOW ONLY £8.99

Thousands of other titles available - to order just discount 20% off the RRP stating title and software company - same fast service

P&P inc UK Europe add £1 per item, elsewhere £2 per item.
Cheque/PO/International Money Orders made payable to 'Amiga Image'

Full 'No Quibble' 1 year guarantee with all products E&OE

NEW!

RaceBase
COMPUTER TIPSTER



RaceBase is a racecard analysis system that
WORKS ENTIRELY ON HORSE RACING
STATISTICS

Proofed to Racing Post over 108 races with a

90% STRIKE!!

from the top three rated, 68% strike from the top 2 and 43% strike from the top rated and 105 points post-tax profit from betting advice on each race.

EASY card-on-the-screen input
AUTOMATIC error-checking, a simple coding system for trainers & jockeys, and
NO FORM INPUT makes RaceBase
VERY FAST - takes minutes not hours.

Simply enter the racecard almost as it appears in the press and optionally update the local trainer table.

RaceBase rates each horse using statistical information stored in its database and generates a computer SP to reveal horses representing value for money.

Works on Flat and National Hunt

WHAT THE PRESS SAYS

"Certainly does a pretty impressive job and RaceBase is worth a flutter" /PC Plus August 89

Available now for PC compatibles only
£105.50 inc. P&P Cheques/P.O.s to:

Prestige Software

18 ST JOHN'S ROAD, HAVANT, HANTS PO9 3TS
TEL: (0705) 452881

TREBLE H



DISKS

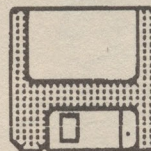

**TOP QUALITY
3 1/2" DS/DD
GUARANTEED
BULK DISKS**

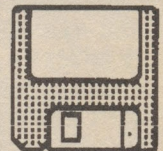

NEW PRICES

10	£7.50
25	£16.90
50	£32.25
100	£62.50
200	£123.00

(SEE TREBLE H COMPUTING AT THE PC SHOW, STAND NO 3441)

INCLUDING LABELS. Add £5.50 for 80 Capacity Disk Box when ordering disks or £4.50 when ordering 50 or more Disks

All prices inc VAT. Please send cheques/P.O. made payable to:
**TREBLE H COMPUTING, Dept POP,
CROMER HOUSE, CAXTON WAY, STEVENAGE,
HERTS SG1 2DF.**
* CREDIT CARD HOTLINE 0438 361738 *
FAX 0438 740794

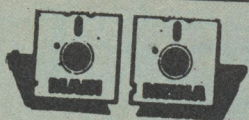

MAIN MEDIA

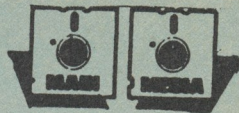

COME AND SEE MAIN MEDIA AT THE PC SHOW
 - and see the Super Deals Available.
 Stand 2530.

FREEPOST, ANDOVER, HANTS SP10 3BR.
Tel: 0264 333830 (24 hrs)

★ **UNBRANDED LIFETIME GUARANTEE** ★

3 1/2" SS/DD	QUANTITY	10	20	30	40	50	100
3 1/2" DS/DD	135TPI	£7.95	£15.50	£22.75	£29.50	£35.75	£69.95
	135TPI	£8.50	£16.50	£23.95	£31.25	£37.95	£74.95
5 1/4" DS/DD	QUANTITY	25	50	100	250	500	
5 1/4" DS/QD	48TPI	£7.25	£13.95	£26.95	£64.95	£124.95	
	96TPI	£7.95	£15.50	£29.95	£77.50	£139.95	

All 3 1/2" Disks come complete with labels. All 5 1/4" Disks supplied with Write Protect Tabs, labels and envelopes and come with our No Quibble Money Back or Replacement Guarantee.

DISKETTE STORAGE BOXES

50 x 5 1/4"	Hinged Lid Lockable	Price Each
100 x 5 1/4"	Hinged Lid Lockable	£5.50
140 x 5 1/4"	Hinged Lid Lockable	£7.50
50 x 3 1/2"	Hinged Lid Lockable	£9.50
100 x 3 1/2"	Hinged Lid Lockable	£5.50
	Hinged Lid Lockable	£7.50

DISK BOXES WITH DISKS

50 x 5 1/4"	Hinged Lid Lockable with	25 DS/DD	48TPI	£11.95
50 x 5 1/4"	Hinged Lid Lockable with	25 DS/QD	96TPI	£12.75
100 x 5 1/4"	Hinged Lid Lockable with	50 DS/DD	48TPI	£20.95
100 x 5 1/4"	Hinged Lid Lockable with	50 DS/QD	96TPI	£22.50
140 x 5 1/4"	Hinged Lid Lockable with	100 DS/DD	48TPI	£35.95
140 x 5 1/4"	Hinged Lid Lockable with	100 DS/QD	96TPI	£38.95
50 x 3 1/2"	Hinged Lid Lockable with	20 DS/DD	135TPI	£21.50
100 x 3 1/2"	Hinged Lid Lockable with	50 DS/DD	135TPI	£44.95

All prices include VAT and Carriage. All Goods despatched within 24 hours subject to availability.

Cheques/P.O.'s to: **MAIN MEDIA, DEPT. POP, FREEPOST, ANDOVER, HANTS SP10 3BR.** Telephone: **Credit Card Hotline 0264 333830 (24 hrs)**



Contriver (Europe) Ltd

WORLD OF IDEAS

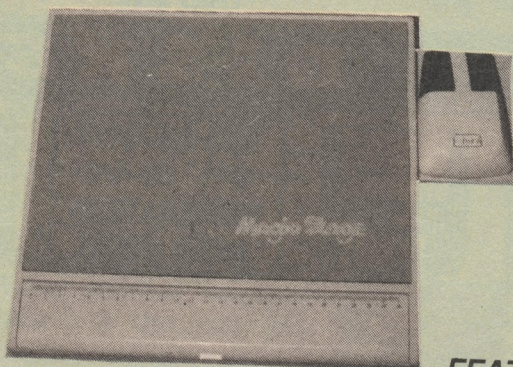

The Original

MAGIC STAGE

FEATURES

- ★ Sits over the top of most keyboards, ideal for desks with a shortage of space.
- ★ Manufactured from high quality ABS plastic and fitted with antistatic rubberised mouse pad.
- ★ Incorporates stationery holder for pens, pencils, rubbers etc.
- ★ Incorporates ruler, scaled in cm.
- ★ Can be folded up when not in use.
- ★ Mouse Tray, to hold mouse when not in use.

RRP £11.95

Contriver (Europe) Ltd are sole UK distributors of the "MAGIC STAGE".
 The original "MAGIC STAGE" is available from all good stockists.

For further information call: **Tel: 0280 822803/4 - Fax: 0280 822805**

LINC SOFT SOFTWARE

57 Maple Street, Bracebridge
Lincoln LN5 8QS. (0522) 535409

Prices shown are Spectrum/Commodore 64 Cassette

ARKANOID II..... 6.36	WAY OF THE EXPLODING
BATMAN..... 7.96	FIST..... 1.89
BLASTEROIDS..... 7.99	JOE BLADE II..... 1.89
BARBARIAN II..... 7.99	BRAVE STAR..... 2.79
CYBERNOID II..... 6.39	RYGAR..... 2.79
DRAGON NINJA..... 7.16	GHOSTBUSTERS..... 1.89
DOUBLE DRAGON..... 7.99	CAULDRON II..... 1.89
NAVY MOVES..... 7.96	METRO CROSS..... 2.79
OPERATION WOLF..... 7.96	KNIGHTMARE..... 1.89
PACLAND..... 7.16	WHO DARES WINS II..... 1.89
R-TYPE..... 7.99	TRANSFORMERS..... 2.79
ROBOCOP..... 7.96	THROUGH THE TRAP
REDHEAT..... 7.19	DOOR..... 1.89
RENEGADE III..... 7.19	W.E.C. LE MANS..... 7.96
ROAD BLASTERS..... 7.19	TAITO COIN OP. HITS... 10.36
RUN THE GAUNTLET..... 7.19	GAME, SET AND
REAL GHOSTBUSTERS..... 7.96	MATCH II..... 10.36
THUNDERBLADE..... 7.19	GIANTS..... 10.99
THUNDERBIRDS..... 7.96	IN CROWD..... 11.95

MOST TITLES AVAILABLE FOR ALL POPULAR COMPUTERS. MAIL ORDER ONLY. TELEPHONE OR WRITE FOR DETAILS AND PRICE LIST FOR YOUR COMPUTER. MAKE CHEQUE OR POSTAL ORDER TO: LINC-SOFT SOFTWARE

SOUTH EAST KENT SOFTWARE

78 SOUTH FLEET ROAD,
ORPINGTON, KENT

0689-50204

SEND FOR FULL LIST ATARI/AMIGA/SEGA/ORNINTENDO

Computers

ATARI 520 STFM POWER PACK.....	£360.00
AMIGA 500 + TV MODULATOR.....	£360.00
ATARI 1040 STFM + MODULATOR.....	£430.00

Printers

ATARI SMM 804.....	£185.00
AMIGA MPS 123.....	£215.00

Joysticks

20% OFF RETAIL PRICES

CRUISER CLEAR	£10.00
SPEEDKING NON AUTO	£8.85
SPEEDKING AUTOFIRE	£9.99
QUICKSHOT II TURBO	£9.95
NAVIGATOR	£10.50
CHEETAH STARPROBE	£12.00

30% OFF RETAIL PRICES
ATARI/AMIGA GAMES
OR
BUY 2 AND GET THE 3rd
FREE
SEND FOR LIST OF GAMES
AVAILABLE

**SEGA SOFTWARE 10% OFF RETAIL PRICES
NINTENDO SOFTWARE 10% OFF RETAIL PRICES**

Payment by cheque or postal order payable to J. Ferguson.

BRANDED DISKETTES

SPECIAL DISCOUNT OFFER UNTIL

• **DECEMBER 15** •

NO VAT – FREE POSTAGE

(U.K. ONLY)

MINIMUM ORDER – 3 BOXES

(10 disks per box)

100% Error Free – Money Back No Quibble
Guarantee – Write/Protect Tabs.

5% Discount on orders over 25 boxes.

Prices are for payment with orders only.

3M – BASF – MAXELL – VERBATIM – FUJI – SONY

3½" DS DD £13.95
3½" DS HD £30.95

5¼" DS DD £7.50
5¼" DS HD £12.95
DC 2000 £16.95
DC 600A £20.95
DC 600 XDD £28.00
DC 300 XLP £19.00

3M Tapes 700 Series 600" £7.50
3M Tapes 700 Series 1200" £9.00
3M Tapes 700 Series 2400" £11.50

IBM 3480 £5.95

DEC – TK50 £28.00

3M Tape 777 Series 600" £5.50
3M Tape 777 Series 1200" £7.50
3M Tape 777 Series 2400" £9.00

HURRY WHILE OFFER LASTS!!

Cheques and Postal Orders to:

NADISYSTEMS

143 Fairfoot Road, London E3 4EJ.

Tel: 01-537 2119

Please allow five working days for cheque
clearance and delivery. Orders with bankers draft
dispatched immediately.

Before DTP costs you an arm and a leg...

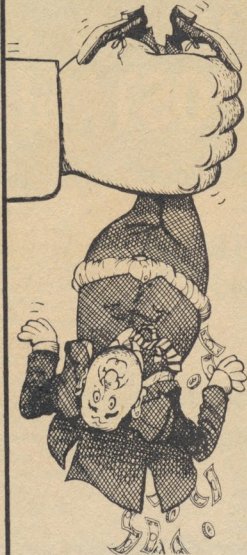

DTP BREAKTHROUGH BY WORDSTREAM

Wordstream Breaking down the barriers of expensive programs, high-cost computers and endless bills, Wordstream Research brings you **CENTREPAGE DTP Club**; page make-up by telephone.

£129 complete – for IBM compatibles

- ★ Timeworks v1.2
- ★ Easy to learn and use
- ★ Hotline support
- ★ WYSIWYG
- ★ Tutorial/Training pack
- ★ 230 Typeface library

CENTREPAGE DTP Club for quality repro at lowest possible cost.

CENTREPAGE, Wordstream House, St. Aldhelms Road, Poole Dorset BH13 6BS Tel: (0202) 752155

Please send me information:

Name: Position:

Company:

Address:

Telephone: W.P.C.

QUALITY DESKTOP PUBLISHING AT LOWEST POSSIBLE COST

WESTONING LTD

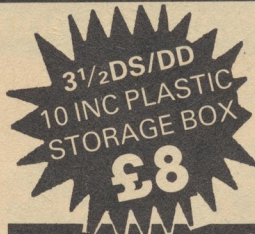

5 1/4" DS/DD

25	50	100
£7	£12	£22

Including Sleeves & Labels

Disks certified 100% Error Free

3 1/2" DS/DD

	25	50	100	200	400	600
720k	£17	£31	£55	£105	£205	£305
880k	£18	£33	£63	£120	£235	£345

Including labels

DISK BOXES

Hinged Lid, Lockable
3 1/2 or 5 1/4
Capacity
50 100
£3.25 £5.75

Add £2 P&P if not ordered with discs

Prices Include
VAT & Carriage



3 1/2" Disk Labels

100	1000
£2.50	£10

State either coloured or white tractor feed

**SAME DAY DESPATCH
NO QUIBBLE GUARANTEE!**

P.S. New low prices on Amigas – Phone

WESTONING LTD Dept POP

12 SANDERSON ROAD, WESTONING,
BEDFORD MK45 5JY

TEL: (0836) 775060 • (0525) 718668

Escroe plc

11 Mundells Court, Welwyn Garden City, Herts AL7 1EN.

Tel: 0707 334460 Fax: 0707 331064



LOOK NO FURTHER!!!



3 1/2 INCH DISKS FROM 39p + VAT.

3 1/2 INCH BULK DISKS	*certified ERROR FREE				
Quantity	10	500	250	100	50
DS/DD uncertified	£6.50	.45	.48	.54	.60
*DS/DD 720K certified	£7.00	.51	.54	.60	.66
*DS/DD 1MB preformatted to 720K	£8.50	.53	.56	.63	.68
*DS/DD 1MB preformatted to 880K	£9.50	.56	.60	.66	.71
*DS/HD 2MB certified	£15.00	1.32	1.38	1.43	1.48

5 1/4 INCH BULK DISKS	*certified ERROR FREE				
Quantity	10	500	250	100	50
*DS/DD 48tpi certified	£3.95	.18	.21	.23	.25
*DS/QD 96tpi certified	£4.95	.21	.23	.25	.27
*DS/HD 1.6MB certified	£7.50	.52	.55	.60	.63

BRANDED DISKS	
3 1/2" SONY DS/DD 135tpi	£12.99
3 1/2" MIMIC DS/DD 135tpi	£11.50
3 1/2" DS/DD 135tpi	£13.99
3 1/2" MIMIC DS/HD 2MB	£18.00
3 1/2" SONY DS/HD 2MB	£29.99
5 1/4" MIMIC DS/DD 96tpi	£5.95
5 1/4" DYSAN DS/DD 96tpi	£9.99
5 1/4" MIMIC DS/HD 1.6MB	£10.99
5 1/4" 3M DS/HD 1.6MB	£12.99

DISC BOXES	
DP020 20x3"	£8.95
DP040 40x3 1/2"	£4.95
DP080 80x3 1/2"	£6.95
DP050 50x5 1/4"	£4.95
P100 100x5 1/4"	£6.95
DP140 140x5 1/4"	£7.95



OR



3 INCH *PREFORMATTED

Quantity	10	500	250	100
*CF2	£17.25	1.30	1.40	1.45
*CF2DD	£26.25	2.20	2.30	2.40
AMSOFT CF2	£23.00	1.84	1.94	2.00
MAXELL CF2	£23.00	1.84	1.94	2.00
MIMIC CF2	£18.50	1.40	1.50	1.60

VIDEO TAPES - HIGHEST QUALITY

Quantity	10	500	250	100
E180	£1.95	1.62	1.72	1.82
E240	£2.75	2.32	2.42	2.52
E180+	£2.35	1.92	2.02	2.22

CLEANING KITS FOR ALL DRIVES

Quantity	1	50	25	10
3"	£4.95	3.00	3.50	4.00
3 1/2"	£1.99	1.25	1.50	1.75
5 1/4"	£1.99	1.25	1.50	1.75
8"	£12.50	8.00	9.00	11.00
CASSETTE	£1.99	1.25	1.50	1.75

NEW SOFTWARE SECURITY & DUPLICATION SERVICE AVAILABLE NOW

ORDERS WELCOME FROM GOVERNMENT, LOCAL AUTHORITY, EDUCATIONAL & CORPORATES.

FOR NEXT DAY DELIVERY SERVICE AVAILABLE Add £6.00 Please.

* (DISKS, DISKS AND MORE DISKS AT TRADE PRICES DIRECT TO THE PUBLIC) (COMPLETE WITH USER SETS AND ENVELOPES) (LIFETIME GUARANTEE) ON CERTIFIED PRODUCTS. PRICES INCLUDE POSTAGE, PACKING AND VAT.

These prices are for payment with order only. Minimum Order Value £30.

CHECK OUT THESE PRICES FOR CONSOLES

PC ENGINE PAL £99.95

SEGA MEGADRIVE PAL £99.95



**WE ARE SELLING GAME CONSOLES
AT WAREHOUSE PRICES.**



WESTLAKE also sell the CD-ROM for the PC engine at equally low prices. Our game titles and stock can't be beaten by any other mail order house and we stock months ahead of our competition.

PC ENGINE AND SEGA GAMES START AT PRICES AS LOW AS £9.95.

CUSTOMERS WILL BECOME IMMEDIATE MEMBERS OF WESTLAKE'S INTERNATIONALLY KNOWN CONSOLE CLUB AND WILL RECEIVE REGULAR NEWSLETTERS OF GAMES UPDATE LIST, FUTURE ACCESSORIES AND OUR CHRISTMAS SPECIAL DEALS.

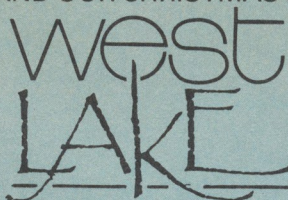

8G, 2 Marconi Road, Kowloon, HONG KONG or call (international) 852-3-794 0285
or Fax: (international) 852-3-871-967

VISA-MASTER Surcharge 2% include A/C No. Expiry date and name shown on credit card.

When ordering add £10 (AD \$20) for consoles. Add £2.50 (AD \$5) P&P for games.

Allow 28 days for delivery

MENTION TECHNICAL SERVICES

PC ENGINE WITH PAL TV CONVERTER/BOOSTER & DRUNKEN
MASTER with a One Year Guarantee!
ONLY £159.95! (+ p&p £5.00)

LIMITED OFFER ONLY £19.99 each (+ p&p £1.50).
While Stocks Last. Galaga 88, Shanghai, Mahjong, Dragon Spirit,
P+47, Deep Blue, F1 Pilot.

NEW TITLES NOW IN STOCK!
(54 Titles Available). Gunhead, Side Arms, Pacland, Ninja
Warriors, Final Lap Twin, Cyber Cross, Baseball II. All £29.95 each
(+ £1.50 p&p or £2.75 for Two or more Titles).

SEGA MEGADRIVE IN SCART. ONLY £179.95 (+ £5.00 p&p).

SEGA MEGADRIVE IN PAL TV*. ONLY £199.95 (+ £5.00 p&p)
*Available soon. Send large SAE for details.

NEW SEGA SOFTWARE NOW IN STOCK!
Ghouls & Ghosts £38.95. World Cup Soccer £31.95
Black belt £31.95. Super League £31.95
(+ p&p £1.50 or £2.75 for Two or more).

Nintendo Japanese Converter & Operation Wolf.
Still Only £43.95 (Inc p&p)

Cheques and Postal Orders/Large SAE for Details:

**MENTION TECHNICAL
SERVICES**
Dept. POP, P.O. Box 18, Helensburgh,
Dumbartonshire G84 7DQ.
Enquiries: (0436) 78827

CREDIT CARD
HOTLINE
0203 611943
ALL MAJOR CREDIT
CARDS ACCEPTED

XENON TECHNOLOGY

MEGA '45' PRICES!

Amiga
Atari ST, IBM PC
Spectrum
C64, Amstrad

MEGA '45' PRICES!



Commodore A590 Amiga 20MB
Hard Drive £345.00
A590 RAM chips at £13.45 each (128k)
512k (4 chips) £52.45
1MB (8 chips) £102.45
1½MB (12 chips) £151.45
2MB (16 chips) £199.45
• BULK DISK •
Minimum order 50 – 70p each inc
labels 3½ DSDD
MINIGEN £99.95
Ext Disk Drive £74.45 • Cordless Mouse
£117.45

Xenon Technology, 71 Wadham Road, North End, Portsmouth.
Hampshire PO2 9LD. Telephone: (0705) 670878.

Please make all cheques or postal orders payable to **Xenon Technology**.
All prices include VAT, postage, packaging and a full guarantee (please add £1.35 per
item overseas). All goods are dispatched within 24 hours (subject to availability) by
FIRST CLASS post.

Kenn Garroch's

A3000 MANDELBROT

A R Patterson of Climping, West Sussex writes:

Q I recently purchased an Acorn A3000 and was very interested in your article on the A3000 in the May 25 issue of *Popular Computing Weekly*,

and in particular your picture of the machine running the "fractals".

I rang your office the other day and it was suggested that I contact Acorn, which I did. They were, however, unaware of such a program and were unable to help.

I was wondering if you could investigate a little further for

me as I would dearly like to get hold of the fractal program.

Incidentally, the program picture was subtitled "Earth Scorching Fractals on the A3000." From the picture, other programs in the directory were Bounce, Bounce3, Fractal, and Intel.

A When reviewing machines I like to test them with programs other than those provided. The A3000 has a good graphics system and plotting the Mandelbrot set looked as though it could prove interesting – and show how fast the machine is (very). The program is converted from a feature published in *Popular* a while back (November 17-23 1988 issue – back issues are available) which explains all of the details. The A3000 program to plot the basic set is shown below; for further information read *The Beauty Of Fractals (Images of complex dynamical systems)* by H.O. Peitgen and P.H. Richter, which is published by Springer-Verlag, ISBN 0 387 158510.

```

10 MODE 15
20 OFF
30 A%=640
40 B%=256
50 PMIN=-2.25
60 PMAX=0.75
70 QMIN=-1.5
80 QMAX=1.5
90 M%=200
100 CMAX=4096
110 DP=(PMAX-PMIN)/(A%-1)
120 DQ=(QMAX-QMIN)/(B%-1)
130 FOR NP%=0 TO A%-1
140 FOR NQ%=0 TO B%=1
150 P=PMIN+NP%*DP
160 Q=QMIN+NQ%*DQ
170 K%=0
180 X=0
190 Y=0
200 XN=(X*X)-(Y*Y)+P
210 Y=2*X*Y+Q
220 X=XN
230 K%=K%+1
240 IF (X*X)+(Y*Y)>M% THEN C%=K% MOD 256:GOTO 270
250 IF K%=CMAX% THEN C%=0:GOTO 270
260 GOTO 200
270 GCOL C% AND 63 TINT C% AND 192
280 PLOT 69,NP%*2,NQ%*4
290 NEXT
300 NEXT
310 *SCREENSAVE MAND1

```

A3000 Mandelbrot set program.

ST C

Richard Shepard of Cheadle Hulme, Cheshire writes:

Q I am extremely grateful to you for printing my last letter and thankful to those readers who came to my aid. I only hope that you can help me with the same effectiveness this time.

My problem is that I would like to program the Atari and I believe that programming in C is quite popular – I've seen a few good Public Domain programs in C. What I would like to know is where I can get a good PD C compiler? And, where would I get a book for the language? I know I can easily get a C compiler for over £60 but I don't have that sort of money.

A There are a couple of C compilers available in the Public Domain. You could try getting in touch with Goodman Enterprises, 16 Conrad Close, Meir Hay Estate, Longton, Stoke-on-Trent, Staffs ST3 1SW, telephone 0782 335650.

There are two C compilers available; probably the better one is Sozbon C which comes complete with documentation and should cost under a fiver! I think that the best book for learning C is the *Big Red Book of C* by Kevin Sullivan, published by Sigma Press, ISBN 0905104 68 4. For more detailed information, *The C Programming Language* by Kernighan and Ritchie published by Prentice-Hall, ISBN 013 110163 3 is the standard work on the subject by the programmer who originated the language (Dennis Ritchie). Apart from these, there are a number of C books available for beginners who know Basic and for experienced users who require extra libraries of specialised functions.

Question Time

ST CART PORT

J Hawker of Ellesmere Port, Cheshire writes:

Q I have been trying to use the cartridge port on my ST for input/output but without success. I've tried to address \$FA0000-\$FB0000 in assembler in supervisor mode but get the same response – "Address error" – every time.

I did read that the port's address has to be changed in software. If so, how would I go about doing it – got any ideas?

As I've been struggling now for the past few months I'm on the verge of giving up, so if anyone can help, even in the slightest, it would be much appreciated.

A The first problem with the cartridge port is that it does not have a write line, ie, it is read only. This means that straight input/output is impossible. However, the limitation is not insurmountable. The trick is to use some hardware that checks for certain addresses being accessed. When they are, an input can be set up that corresponds to that address. If there were 256 of these addresses then 8 bits of

```

loop    lea    $FA0000,a0    Address of the start of the cartridge space
        move   (a0)+,d4      Read the space
        bsr    whprint       Print hex result as a word
        cmp.l  #$FC0000,a0   Is that the end?
        bne.s  loop         No so next
        move  #0,-(sp)      Return to GEM
        trap  #1            With this

hprint  movem.l a0-a6/d0-d7,-(sp)
        move  #4,d2
lhprintl move  d4,d3
        lsr.b  d2,d3
        and.l  #15,d3
        lea.l  figs,a2
        move.b 0(a2,d3),d0
        bsr    sprint
        subq  #4,d2
        bpl   lhprintl
        movem.l (sp)+,a0-a6/d0-d7
        rts

whprint rol    #8,d4
        bsr    hprint
        rol    #8,d4
        bsr    hprint
        rts

sprint  move  d0,-(sp)      Stack the char to be
        move  #2,-(sp)      Code to print a char
        trap  #1            Doit
        addq.l 4,sp        Correct stack
        rts

figs    '0123456789ABCDEF'
    
```

data can be output, ie, reading the first address would cause the circuitry to set up a 0, the second address a 1, the third a 2, etc., all the way up to 255. The software is pretty simple and since there is a wide address

range available (128K), there should be no trouble with shortage of space. Needless to say, inputting data is simple by comparison, the external hardware need only check that the input address is being accessed and put the data

onto the data bus.

As for accessing the cartridge memory port, I can't see any problem reading from it, try the test program. This will only read in \$FF for the 128K bytes but should prove that it is possible. The problem of the address error is due to the GLUE chip objecting to write access in this area of memory. Incidentally, you don't need supervisor mode.

OK KO

Tony Bernascone of Middlesbrough, Cleveland writes:

Q Oh dear, oh dear – it's still wrong. With respect to the C64 composite video connection, on both old and new sockets, the pins used and their numbers are the same! It will work using pin 1 (LUM/SYNC) on the "new" socket but the quality is poor.

A Having tried both the connections, the LUM/SYNC connection works better

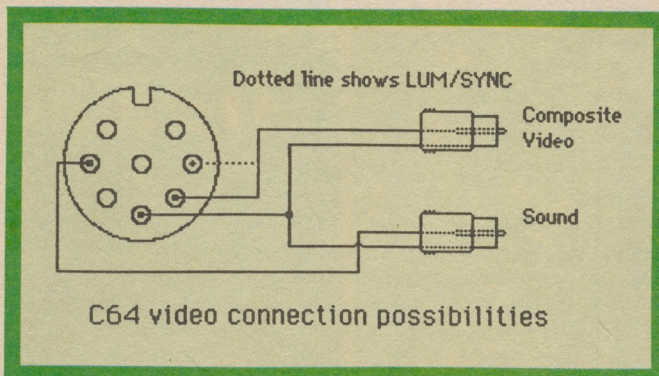

with my monitor. Then again, it is a rather old green screen monitor so, as the picture is not all that good in the first place, maybe this is the

reason. Perhaps it is for people constructing a lead to try both possibilities to see which is best. In the diagram,

the solid lines show Mr Bernascone's preferred connection, the dotted line shows the alternative – use one or the other.

Incidentally, the LUM/SYNC connection has the advantage that the connecting lead for the Commodore 1901 colour monitor can be used for a mono/composite monitor as well – the yellow lead plugs straight in and is connected to pin 1 on the 8-pin C64 plug. Anyhow, my apologies to anyone who was confused, and I hope that this now sorts things out.

XENON TECHNOLOGY

MAIL ORDER

MEGA '45' PRICES!

Amiga, Atari ST, IBM PC Spectrum, C64, Amstrad

MEGA '45' PRICES!

MAIL ORDER

TOP 30	Title	Amiga	ST	PC	Spec	C64	Amstrad
1	Xenon II Megablast (Image Works)	£15.45	£15.45	£15.45	NOT AVAILABLE	NOT AVAILABLE	NOT AVAILABLE
2	Batman The Movie (Ocean)	£16.45	£13.45	£6.45	£6.45	£6.45	£6.45
3	Bloodwych (Image Works)	£16.45	£16.45	£16.45	£6.45	£6.45	£6.45
4	Gemini Wing (Virgin Games)	£13.45	£13.45	£16.45	£6.45	£6.45	£6.45
5	Leonardo (Starbyte)	£13.45	£13.45	£16.45	£6.45	£6.45	£6.45
6	Stunt Car (Micro Status)	£13.45	£16.45	£16.45	£9.45	£9.45	£9.45
7	Shinobi (Virgin)	£13.45	£13.45	£16.45	£6.45	£6.75	£6.45
8	A.P.B. (Tengen)	£13.45	£13.45	£16.45	£6.45	£6.45	£6.45
9	Xenophobe (Micro Style)	£16.45	£13.45	£16.45	£6.45	£6.45	£6.45
10	Robocop (Ocean)	£16.45	£13.45	£16.45	£6.45	£6.45	£6.45
11	Beach Volley (Ocean)	£16.45	£13.45	£16.45	£6.45	£6.45	£6.45
12	Infestation (Psygnosis)	£16.45	£16.45	£16.45	£6.45	£6.45	£6.45
13	Mr. Heli (Firebird)	£16.45	£16.45	£16.45	£6.45	£6.45	£6.45
14	F-16 Combat Pilot (Digital Int.)	£16.45	£16.45	£16.45	£6.45	£6.45	£6.45
15	Vigilante (US Gold)	£13.45	£13.45	£13.45	£6.45	£6.45	£6.45
16	Dynamite Dux (Activision)	£16.45	£13.45	£13.45	£6.45	£6.45	£6.45
17	Paperboy (Elite)	£13.45	£13.45	£16.45	£6.45	£6.45	£6.45
18	Rick Dangerous (Firebird)	£16.45	£13.45	£16.45	£6.45	£6.45	£6.45
19	Populous-Promised Lands (E/A)	£6.45	£6.45	£16.45	£6.45	£6.45	£6.45
20	Light Force (Ocean)	£16.45	£16.45	£16.45	£6.45	£6.45	£6.45
21	Honda HV750 (Micro Style)	£13.45	£13.45	£16.45	£6.45	£6.45	£6.45
22	Red Lightning (US Gold)	£16.45	£18.45	£18.45	£6.45	£6.45	£6.45
23	Rainbow Island (Firebird)	£16.45	£16.45	£13.45	£6.45	£6.45	£6.45
24	Indiana Jones/LC (Lucasfilm)	£13.45	£13.45	£13.45	£6.45	£6.45	£6.45
25	The New Zealand Story (Ocean)	£16.45	£13.45	£13.45	£6.45	£6.45	£6.45
26	Ivanhoe (Ocean)	£16.45	£13.45	£13.45	£6.45	£6.45	£6.45
27	Falcon Mission Disk Vol. 1 (Mirrorsoft)	£13.45	£13.45	£13.45	£6.45	£6.45	£6.45
28	Passing Shot (Image Works)	£16.45	£16.45	£16.45	£6.45	£6.45	£6.45
29	Quarterback (Virgin)	£13.45	£13.45	£16.45	£6.45	£6.45	£6.45
30	Cabal (Ocean)	£16.45	£13.45	£16.45	£6.45	£6.45	£6.45

Xenon Technology, 71 Wadham Road, North End, Portsmouth, Hampshire PO2 9LD. Telephone: (0705) 670878.
Please make all cheques or postal orders payable to **Xenon Technology**. All prices include VAT, postage, packaging and a full guarantee (please add £1.35 per item overseas). All goods are dispatched within 24 hours (subject to availability) by FIRST CLASS post.

DISKS

3" CF2	Per 5.....£10.22
	Per 10.....£19.52
3.5" DS/135tpi	Per 10.....£11.26
	Per 25.....£19.52
5.25" DS/96tpi	Per 10.....£5.61
	Per 25.....£12.56

DISK STORAGE - TOUGH LOCKABLE

Box for 3"	Holds 30.....£8.48
Box for 3.5"	Holds 30.....£8.48
Box for 5.25"	Holds 100.....£9.96

RIBBON REFRESH The unique fabric ribbon restorer 160ml can £7.78 + VAT

RIBBONS FOR ALL MAKES OF PRINTERS
If yours is not listed - give us a call

	1 off £	2 off £	5 off £
Amstrad DMP 2000	F 3.44	6.48	14.74
Amstrad DMP 4000	F 5.17	9.52	19.96
Amstrad 3000	F 3.44	6.48	14.74
Amstrad 8256/8512 Std. Life	F 3.44	6.48	14.74
Amstrad 8256/8512 LongLife	F 4.30	7.78	17.35
Amstrad 8256/8512 F Colours: Red, Blue, Green, Brown	F 4.30	7.78	17.35
Amstrad 8256/8512	MS 3.44	6.48	14.74
Amstrad 9512 Std. Life	F 3.44	6.48	14.74
Amstrad 9512 LongLife	F 4.30	7.78	17.35
Amstrad 9512 Fbr Colours: Red, Blue, Green, Brown	F 4.30	7.78	17.35
Amstrad 9512	MS 3.44	6.48	14.74
Brother AX10, AX15	F 3.65	6.93	16.42
Brother HR15/25/35	F 3.57	6.78	16.06
Brother HR15/25/35	MS 4.03	7.66	18.13
Citizen 120D	F 3.44	6.48	14.74
Citizen Premier 35	MS 2.43	4.62	10.94
Citizen Premier 35	F 2.99	5.69	13.45
Citizen MSP10	F 4.14	7.87	18.63
Epson FX1000, 105	F 4.30	7.78	17.35
Epson MX/RX, FX800, FX85 FX80	F 3.44	6.48	14.74
Epson LX80/LX86	F 2.47	4.70	11.11
Epson LQ1500	F 4.22	8.03	18.99
Epson LQ800	F 4.14	7.87	18.63
Epson LQ1000	F 4.38	8.32	19.71
Epson EX800/1000	F 5.17	9.52	19.96
Epson LQ2500	F 4.73	8.96	21.28
Epson 2550	F 3.86	7.34	17.37
Gäkken	F 4.30	7.78	17.35
Gäkken	MS 3.44	6.48	14.74
Hewlett Packard Deskjet	F 12.80	24.30	59.96
Qume 1v Sprint 7/9	F 4.30	7.78	17.35
Qume 1v Sprint 7/9	MS 3.44	6.48	14.74
Seikosha FP800 Longlife	F 4.30	7.78	17.35
Star Radix 15	F 5.47	10.40	24.61
Star SD15	F 5.68	10.79	25.56
Star NX15	F 5.71	10.85	25.69
Star LC10	F 4.30	7.78	17.35
Star LC2410	F 3.50	6.65	15.75
Star NB15	F 6.37	12.10	28.66
Star NL10	F 6.37	9.70	22.99
Star SD10	F 4.81	9.15	21.64
Star NCR10	F 4.30	7.78	17.35

MS = Multistrike, F = Fabric

CONTINUOUS STATIONERY

	Forms/Box	Price/Box £
11 x 9.5		
1 Part 60GSM (M)	2000	13.88
1 Part 70GSM (M)	2000	15.68
1 Part 80GSM (M)	2000	17.40
1 Part 85GSM (M)	1000	11.76
2 Part NCR	1000	18.60
3 Part NCR	700	21.79
4 Part NCR	500	22.84
2 Part NCR TINT	1000	21.60
3 Part NCR TINT	750	25.70
4 Part NCR TINT	500	26.00
11 x 9.25		
1 Part 60GSM (M)	P 2000	15.08
11.66 x 9.25 (A4)		
1 Part 60GSM (M)	P 2000	17.32
1 Part 70GSM (M)	P 2000	17.92
1 Part 80GSM (M)	P 2000	20.48
1 Part 85GSM (M)	P 1000	12.76
2 Part NCR 80/57	P 1000	29.20
8 x 12		
1 Part 60GSM	P 2000	13.84
1 Part 70GSM (L)	P 3000	20.36
11 x 14.5		
1 Part 60GSM	• 2000	17.76
1 Part 70GSM	• 2000	19.56
2 Part OTC	• 1000	20.03
2 Part NCR	• 1000	23.60
3 Part NCR	• 700	29.23
11 x 8.5		
1 Part 60GSM	P 2000	13.84
2 Part NCR	P 1000	18.32

* = Plain or Music Ruled P = Plain only (M) = Micro perfs all edges (L) = Laser Quality TINT = Coloured Paper 2 Part - White/Pink 3 Part - White/White/Pink 4 Part - White/Yellow/Green/Pink

LOOSE LEAF PAPER

A4 80GSM White Bond	Per ream (500)	6.91
A4 70GSM White Bond	Per ream (500)	6.48

Dunning COMPUTER SERVICES

Dept. PCW, 32 Granville Road, Bournemouth, Dorset. BH5 2AH (0202) 431762

All prices include Carriage - just add V.A.T. @ 15%. Enquiries welcome on our Help Line. Cheques/P.O.'s with order please. Or phone Credit Card Hotline

COMPUTER LABELS

Top Quality Avery Brand
FREE Tape Dispenser/Cutter worth £4.99 + VAT with every 10000 labels!

	2000 £	5000 £	10000 £
1 ACROSS			
2 3/4 x 15/16	6.96	14.48	25.52
2 3/4 x 1 7/16	8.48	18.04	32.13
3 1/2 x 15/16	7.39	15.52	27.43
3 1/2 x 1 7/16	9.52	21.70	36.83
3 1/2 x 1 15/16	12.96	28.57	51.78
4 x 15/16	7.78	16.61	29.52
4 x 1 7/16	9.96	21.43	38.52
4 x 1 15/16	13.09	28.83	52.13
2 ACROSS			
2 3/4 x 15/16	6.39	13.17	23.04
2 3/4 x 1 7/16	7.61	15.96	28.30
3 1/2 x 15/16	7.13	14.87	26.17
3 1/2 x 1 7/16	9.52	21.70	36.83
3 1/2 x 1 15/16	12.96	28.57	51.78
4 x 15/16	8.04	17.00	30.22
4 x 1 7/16	9.96	21.43	38.52
4 x 1 15/16	12.78	28.09	51.26
3 ACROSS			
2 3/4 x 15/16	6.23	12.85	22.32
2 3/4 x 1 7/16	7.51	15.76	27.80
3 1/2 x 15/16	6.36	15.96	28.10
3 1/2 x 1 7/16	7.13	14.87	26.17
3 1/2 x 1 15/16	8.48	18.04	32.13
4 x 15/16	11.46	24.63	44.52
4 x 1 7/16	7.13	14.87	26.17
4 x 1 15/16	9.66	20.83	37.52
4 x 1 15/16	12.68	27.89	50.76

ENVELOPES - QUALITY COMMERCIAL RANGE

	Box Qty	Price £
3 1/2 x 6 Manilla Gummed	1000	8.07
3 1/2 x 6 White Gummed	1000	10.08
C6 Manilla Gummed 4 1/2 x 6 3/8	1000	11.58
C6 White Gummed 4 1/2 x 6 3/8	1000	14.12
DL Manilla Gummed 4 1/4 x 8 5/8	1000	11.26
DL Manilla (Window) 4 1/4 x 8 5/8	1000	13.00
DL White S/Seal 4 1/4 x 8 5/8	1000	15.52
DL White S/Seal (Window)	1000	16.71
9 x 4 Manilla Gummed	1000	11.12
C5 Manilla Gummed 9 x 6 3/8	500	9.52
C5 White Gummed 6 3/8 x 9	500	12.13
C5 White S/Seal 6 3/8 x 9	500	13.13
C4 Manilla Gummed 12 3/4 x 9	250	9.09
C4 Manilla S/Seal 12 3/4 x 9	250	10.39



ONCE BYTTEN

59 Swanley Road, Welling, Kent DA16 1LL.
Tel: 01-304 2631 - Fax: 01-304 7214.

SAFTER COMPUTING . . . BUY ALL YOUR AMIGA EQUIPMENT FROM AN AUTHORISED COMMODORE DEALER (us for example!!)

HARD DRIVES

AMIGA A500
Commodore A590 20Mb + 2Mb RAM (unpopulated) £399.00
£649.00
A590 20Mb + 2Mb RAM (fully populated) £399.00
Amdrive 30Mb 28ms £475.00
Amdrive 50Mb £550.00
Vortex 40Mb (interchangeable interface) Amiga £525.00
Impact Autoboot 30Mb + 2Mb RAM (unpopulated) £679.00
Quantum Autoboot 40Mb + 2Mb RAM (unpop) 11ms £679.00

AMIGA A2000

GVP Hard Cards (Autobooting with 1.3)
SCSI Controller and Hard Drive on one slot-in card
30Mb Impact 40ms £499.00
40Mb Impact 28ms £549.00
40Mb Quantum 11ms £629.00
60Mb Quantum 11ms £899.00

REMOVABLE HARD DISK (needs SCSI controller)

GVP/Syquest 44Mb removable Hard Disk (autobooting) £750.00
£89.00
44Mb Cartridges £219.00
SCSI Controller/RAM cards from

X-COPY II

We now have the latest version (2.0) of this popular utility. Now includes FREE Editor for Text or Programmes. Please note that this is a very POWERFUL utility and in view of recent legislation we must insist that it is sold only on the strict understanding that it is used for personal backups of software which you already own.

X-COPY II . . . STILL ONLY £19.95
Upgrade (from 1.2 or 1.3 purchased from us) send copy of invoice + £5.00
Ring for further upgrade news. COMING SOON . . . Son of X-COPY II.

DISCS

Unbranded MAXELL 3.5" DSDD 135 TPI bulk packed discs. Made in Japan with labels, fully guaranteed for life. Why buy unknown makes? Buy quality.
■ 10 boxed - £10.95 ■ 10 - £9.90 ■ 25 - £22.95 ■ 50 - £43.50 ■ 100 - £84.50 ■ 200 - £180 ■ 400 - £310
Unbranded ATHANA 5.25" DSDD 96 TPI bulk packed discs. Made in USA with sleeves and labels. Fully guaranteed for life.
■ 25 - £9.95 ■ 50 - £18.50 ■ 100 - £32 ■ 250 - £75 ■ 500 - £144 ■ 1,000 - £275

FAST PROCESSORS

GVP 88030 Accelerator Board for 2000
25MHz built in MMU, Maths Co-Pro Socket,
Asynchronous design £829.00

16Mhz specification otherwise as above £539
4Mb 32 bit-wide RAM daughter board for above. Zero wait-state £1,349
8Mb 32 bit-wide RAM daughter board. Zero wait state £2,495
16Mhz 88882 Maths Co-Processor £275
25Mhz 68882 Maths Co-Processor £450

PRINTERS

HEWLETT PACKARD (All with one year on-site warranty)
Deskjet (300X300DPI. HPLaserJetII Compatible, 16k Buffer) £545
Deskjet Plus (new model, features as above but faster) £669
Paintjet (incredible colour ink jet printer) £819
Lasterjet II - sets the standard for the rest! 8ppm 512k RAM £1,850

CITIZEN

(all with two year return to base warranty)
120D 125CPS 9 pin printer with tractor and friction feed £137.50
HQP-40 200 CPS 24 pin printer. Colour capable, best buy £389.95
Colour kit for HQP-40 £39.85
Premiere-35 35CPS Daisy Wheel printer. With free tractor feed £459.95
Overture 106 laser printer 6PPM very small footprint £1,199.00

STAR

Fabulous deals on LC-10 mono and colour. Limited stocks.
LC-10 mono 8NLQ resident fonts. 144CPS Paper park £169.00
LC-10 colour as above but with 7 colour capability £199.00

LC24-10 mono 170CPS. 24 pin version of LC-10 high quality output £349.00
NEWXB24-10 240CPS 24 pin colour capable (RRP £690) £529.00
Colour kit for XB24-10 £44.00

SECONDHAND

(some of our stock AC at 31/0/89)
Amiga 1000 513K + 3Mb RAM + 30Mb hard disc + clock £50.00
Amiga 2000 B with 1Mb RAM 2x Floppies + 80Mb hard disc £1,350.00
2Mb RAM (A1000) Comspec - £350 • 20Mb Supra (A1000) - £350.00
Psion Organiser XP - £79.00 • Excellence - £79.00
Professional Page - £89.00 • CSA 68020/68881 - £850.00
Flicker Fixer + 15" Multisync Monitor (boxed as new) £750.00
Commodore SX64 2250 BBC Mono B £189.00
Our stock is changing daily. Please call in case we've got it now!

PART EXCHANGE - We are part exchange specialists. For a realistic quote please ring.

We welcome official orders from schools, universities, hospitals, medical schools and Government departments. Quantity discounts always available and export enquiries are dealt with speedily.



All prices INCLUDE VAT at 15%. Carriage extra on hardware. Ask for quote. Cheques to AMTEN LTD
Write to: 59 SWANLEY ROAD, WELLING, KENT DA16 1LL or tel: 01-304 2631
callers welcome but please phone first. We are open Mon-Sat 9am to 10pm

COMPUTER REPAIR SPECIALIST

★ SALES AND SERVICE ★

Acorn - Amstrad - Sinclair - Commodore, etc.

NO FIXED PRICE FOR REPAIR

We charge just £15 labour plus the parts cost

eg: Com 64 - 1 ram chip faulty

Parts £2.00
Labour £15.00
Total Cost £17.00

Please phone before posting

P & J ENTERPRISES

18 Anston Ave, Worksop, Notts S81 7HT. Tel: 0909 483255

WANTED FOR CASH

IBM COMPATIBLE COMPUTERS & EQUIPMENT

JOB LOT BUYER OF HARDWARE & SOFTWARE

PROMPT DECISION & COLLECTIONS

FOR YOUR BEST POSSIBLE DEAL CALL

EXPRESS COMPUTERS

(0604) 769808 OR FAX 705567

DAVID OR CHRIS (DEPT NCE 1)

DISKS 65p

3.5" DS/DD KAO UNBRANDED ALL DISKS

GUARANTEED (MIN. ORDER 30)

AMIGA A500 £330

PLEASE ADD P&P TO ALL ABOVE ITEMS
ALL PRICES INCLUDE VAT

COMMARI COMPUTERS

97 UPPER PARLIAMENT ST, NOTTINGHAM NH1 6LT

Telephone: (0602) 507423/475166

COMPUTER REPAIRS

Fixed Price Repairs For:

ACORN, AMIGA's, AMSTRAD, ATARI,
COMMODORE, SPECTRUM's, ST's and QL's.

Includes - Delivery, Parts, Labour, Full Service, VAT,
90 Day Warranty and 5 Day Turnround
(Subject to Parts Availability) Collection can be arranged.

All our Engineers are fully experienced in 8 and 16 Bit
Technology. We also repair Business Computers,
Monitors, Printers and Computer Terminals, etc.

Low Cost Maintenance Contracts Available.

Educational and Dealer Discounts Given.

SHIELD COMPUTER SERVICES LTD,
50 FLIXTON ROAD, URMSTON,
MANCHESTER M31 3AB

Telephone: 061-747 3185

Fax: 061-747 0515

SOFTCELL SUPER SAVERS PC SHAREWARE £1.75 per Disk fully incl.

Copy Master £1.75
Tree View £1.75
Pensy Dos £1.75
Dos Tech Ref £1.75
OS II Manual £1.75

Word Games £1.75
PC Dash Board £1.75
Theasaurus £1.75
STD Codes £1.75
"100s more"

PC & AT
Range
Quality
Value
Free Software

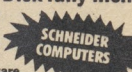

10 5/14 Disc £16, 10 3 1/2 Disc £25.00. For further details write or phone for
a FREE catalogue! Schneider Services, Dept POP, 9 St Wells St, Cardiff CF1 8DW.
Tel: Cardiff (0222) 222895 anytime

PLAY WITH ME - ADULTS ONLY.

Dial 0898 442 887 now!! (25p/38p per min) ... we dare you to listen.

ADULTS ONLY - Dial 0898

442334 Now!! (25p/38p per min). We dare you to listen.

COMPUTER GAMES

To gamble free of charge try the Grand National. Win \$5,000 or go to Bankrupt.
On tape for Commodore +4 (£3.50).

For further details ring

(0292) 611566 after 6pm every day!

UNBRANDED DISKS

TOP QUALITY 100% GUARANTEED WITH LABELS

10 3 1/2 DD DS 135 TPI £7.00
20 3 1/2 DD DS 135 TPI £13.95
30 3 1/2 DD DS 135 TPI £20.50
100 DISCS FOR £69.00

PRICE INCLUDES P - P - Cheque - PO to:
Mr G S Bradley, 49 Churchill Avenue, Wyton,
Huntingdon, Cambs. PE17 2EG TEL: 0480 454296

NOVA PRESENTS - FOR THE AMIGA

NOVA PD CLUB.
The spirit of Amiga PD FREE life membership. ALL popular Amiga PD collections, only £2 per disk. 1st four disks - FREE catalogue disk only £5.50. Up to 75% off commercial software, many more benefits. Write or phone for details.

NOVA DISK MAGAZINE
Issue 3 available now - 3 disks - only £5. Games, reviews, articles, programs and lots more. Includes plans for a complete sound sampler. Reduced price for NOVA PD CLUB members. Programs ART and TEXT compressed by up to 55%. Cheques/POs payable to NOVA.

4 Octavian House, Dashwood Road, Banbury, Oxon. Tel: 0295 259682

E.M.P.D.L.

Amiga Public Domain Library. Open 7 days 9am - 9pm

Immediate despatch on all orders £5 per year subscription includes 3
Catalogue Disks (regularly updated FREE)
Range of accessories etc. Ring or write now for details

Cheques & PO's payable to:

E.M.P.D.L. 54 WATNALL ROAD, HUCKNALL, NOTTS
Telephone: 0602 630071

FORMAT FOR THE FUTURE?

by Neil Hewitt

MUCH HAS been said in the last few years about optical disc being the next mass-storage revolution; and yet despite the fact that Astron Belt and Dragon's Lair on the games side, and the BBC Domesday Book project on the serious side, have been around for several years now, very little has actually happened to affect the home user.

All that should soon be about to change. ST owners should take it as a blessing, not a curse, that Atari seems to have dropped the CD-ROM player from its plans. Very few people have use for such "read-only" systems.

More encouraging news comes from Philips, whose CD-V and CD-I formats (CD-I being relevant to computers in particular), look like leading the way forward. And despite the distinct lack of media coverage, full read-write-erase CD drives are already in production, albeit at a hideously prohibitive price. The combination of these two technologies could have profound implications for the future, not only for computer storage, but for audio-visual entertainment in general.

Let's take a leap into that future, to a time where the manufacturers, for once, have agreed on a common standard. Let's call it CD-Universal, or CD-U. This one format would be able to store data, video, and digital audio on one small compact disc. Thanks to today's recently-developed shorter wavelength lasers, CD-U can now store up to six hours full digital video with audio, providing home video recording of a standard never before seen. Although CD-V video albums are in the shops even now, they are still the massive 12-inch discs of Laservision fame.

Many homes would be in-stalled, like central heating is today, with a home computer network. A central processing unit, set up in the living room like a stacking hi-fi, would form the nerve centre of this network. The basic storage media for it would be CD-U. An adaptation of one of today's six-disc players would give the family plenty of gigabytes of storage, whilst allowing interchange of discs. The same drive would take video-audio discs in CD-U format, and would be connected to stereo electronics and speakers, and a high-quality, probably flat-screen, monitor and tuner

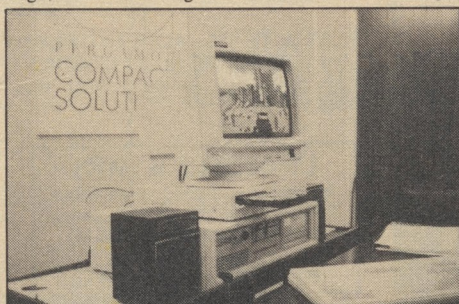

part of this network. "Phone-jack" style sockets around the house would allow the plugging in of terminals, to access the computer. This "micro-mainframe" would be capable of multi-user interaction, have between fifty and a hundred megabytes of on-board RAM, display in ultra-high res and literally millions of colours. A friendly user interface would give access to the system by touch screen, mouse, or voice recognition. The computer would talk by speech synthesis.

The family CD-U multi-player would store hundreds of gigabytes of information and knowledge bases as well as applications software, and a fully interactive multimedia system, controlled by a Hypercard-like program, would allow access to a vast array of text, graphics, video sequences and still photos, as well as digital audio sound. The learning and entertainment possibilities are enormous. Imagine learning French from a computer which could listen to your answers and correct your pronunciation from a vast library of source material, video clips of French speakers, etc. Also imagine the huge and complex video games, adventures, and applications you could run on such a system, from any room in the house.

Self-diagnosis programs would give you an idea of what was wrong with you before you even went to see the doctor. The terminal in your room would act as alarm clock, personal organiser, and even patch you into TV or audio. An exciting prospect is a system whereby these terminals would become personal 'phones, connected to BT's optical comms network (when we get it!), with tiny cameras installed in the flat-screen colour LCD display, providing a video-phone system. The central processor would store your telephone directory, which would be updated by 'phone every month or so, and you could easily connect via modem to a computerised Directory Enquiries à la

unit. Video could be recorded from TV broadcasts, now in Nicam digital stereo and video, of course, and films could be hired on CD-U format.

But the computer side is by far the most interesting

Minitel. Importantly, it is not some futuristic flight of fancy; the technology exists TODAY. It just has to be brought together in a brilliant fusion of electronics and software. Are you listening, Uncle C?

NEXT WEEK

On sale Thursday, October 5th

PC SHOW REPORTS

All the news that is news from the UK's foremost business and leisure computing event.

Popular scribes will be on hand to provide you with all the gen - on gossip, games, micros, bundles and special offers. In the run up to Christmas, you can't afford to miss it!

SAM IN A BOX

Now MGT has squeezed its SAM micro into a box, John Wase gives a run down on its performance.

SIMULATIONS

Lee Paddon takes another spin on a Falcon Mission Disc.

REVIEWS

We review an ST package that will teach you how to play guitar, plus a C64 program for budding adventurers.

PLUS...

- UK and US news
 - QUESTION TIME with Kenn G
 - Your Letters and Listings.
- At just 55p, no one can beat it!

Cosmo



by Jules

Spectacular
Speed and
Stacks of
Software on your
Spectrum +3

WINNER
1988 8-bit Utility of
the Year Award

CP/M Plus Mallard BASIC

NOW YOU CAN TURN YOUR SPECTRUM +3 INTO A REAL COMPUTER!

VAST RANGE OF SOFTWARE

CP/M Plus is the latest version of CP/M, the standard operating system for Z80 computers. This means that there's lots of software ready and waiting to run on your Spectrum +3.

STANDARD DISCS

CP/M Plus for the Spectrum uses the same discs as +3DOS, so you'll be able to read and write your Spectrum discs. But it can also use the discs for the most popular CP/M machines about – the Amstrad CPC and PCW – so you'll be able to run many CP/M programs for these machines as well.

STANDARD SCREEN

CP/M Plus on the +3 can emulate a standard 24 line, 80 character screen, so most existing CP/M software should run without any problems – we've even kept the control characters the same as the Amstrad CPC and PCW computers, so CP/M programs for these machines should run with little or no change.

FAST BASIC

Using the PCW benchmarks, Mallard BASIC is five times faster than Spectrum BASIC and it's more accurate too!

POWERFUL BASIC

Mallard BASIC understands +3 discs – so you can read and write disc files, serially or randomly. Using Mallard's built-in "Jetsam" commands, files can be indexed by key and sorted into alphabetical order. You could use this, for example, to create a database. Jetsam is designed to give quick access to your data.

COMPATIBLE BASIC

Mallard is compatible with the industry standard BASIC, so there's lots of public domain programs you can pick up and run with little or no change. Once you've written your own programs, you'll find it easy to move them to other, more powerful, computers. Mallard also runs on PC compatibles and on the Amstrad PCWs.

But don't just take it from us,
Crash magazine's verdict was:

"At £30 for CP/M Plus, utilities, and Locomotive [Mallard] BASIC, this package is a bargain if you're at all interested in computers for their own sake. . . . Even if you don't want to be a hacker, you can be a 'power user' with CP/M, using whatever parts of it appeal, to run a customised computer system for work, business or fun."

CP/M Plus is a trademark of Digital Research Inc.

Mallard BASIC is a trademark of Locomotive Software Ltd.

To:
Peter Grant,
Locomotive Software,
Allen Court, Dorking,
Surrey RH4 1YL
(0306) 740606

From: _____

Postcode _____

Please send me the following for the Spectrum +3:

- CP/M Plus & Mallard BASIC for the +3 £29.95
Including 350 page User Guide to CP/M and Mallard BASIC
- Mallard BASIC Reference manual £9.95
- Total _____
- I enclose a cheque payable to Locomotive Software
- Please charge to my Access Card

--	--	--	--	--	--	--	--	--	--

Signature _____



**LOCOMOTIVE
SOFTWARE**

KICK OFF

BLISTERING PACE PIXEL PERFECT
PASSING SUPERB TACTICAL PLAY



- * Full size multi-directional scrolling pitch.
- * Option to practice and learn ball control, take corners and practice penalties.
- * One or two player option: 4 distinct tactics.
- * League competition for 1 to 8 players. Load and Save league facility.
- * Simple controls to dribble, shoot, pass, chip or head the ball or do a sliding tackle.
- * 9 types of Corner Kicks, Penalties, Yellow and Red Cards, 12 different Referees. Host of other features.

AVAILABLE ON

AMIGA	£19.95
ATARI ST.....	£19.95
CBM 64 Cass.....	£9.95
CBM 64 Disc.....	£14.95
IBM PC Comp.....	£24.95
SPECTRUM Cass.....	£9.95
SPECTRUM Disc.....	£14.95
AMSTRAD Cass.....	£9.95
AMSTRAD Disc.....	£14.95



**KICK OFF
SCORES WITH REVIEWERS**



- * CVG - OVERALL 88% - Most playable soccer simulation in binary history. Realism is the name of the game. HIGHLY RECOMMENDED.
- * ZZAP - OVERALL 96% - So Realistic, So Fun, Soooo Addictive. Boots all other football simulations over the crossbar.
- * AMIGA FORMAT - GOLD - OVERALL 91% - The best football game on the Amiga today.
- * THE ONE - OVERALL 88% - The game is such a joy to play. By far the best to appear on 16 bit. It is all over bar the shouting.
- * POPULAR COMPUTING WEEKLY - OVERALL 94% - The opposition gets blown away by the utter brilliance of KICK OFF, which has the proper options and the best gameplay seen in any football game.
- * THE ACE - A great football game that will have you queuing up for a season ticket.
- * NEW COMPUTER EXPRESS - KICK OFF is simply the best football sim. we've played on any micro. It's fast, furious and immense fun. Go and buy it.
- * THE GAMES MACHINE - OVERALL 87% - Best 16 bit soccer simulator yet. True football skills are needed in every sense of the word.
- * ST USER - OVERALL 9 - The whole game is a complete delight to play and immediately addictive. This is one of the fastest and most exciting action games around and it just has to be the best football simulations yet.

PLAYING IT IS EASY - MASTERING IT WILL TAKE TIME - A LOT OF TIME



AMIGA



ATARI ST



CBM 64

ANCO

ANCO SOFTWARE LTD., UNIT 10, BURNHAM TRADING ESTATE, LAWSON ROAD,
DARTFORD, KENT.
Mail Order by Cheque, Postal Order, ACCESS or VISA.
Telephone No.: 0322 92513/92518.
FAX No.: 0322 93422.